

# BENITO -Play

## JPVRM45

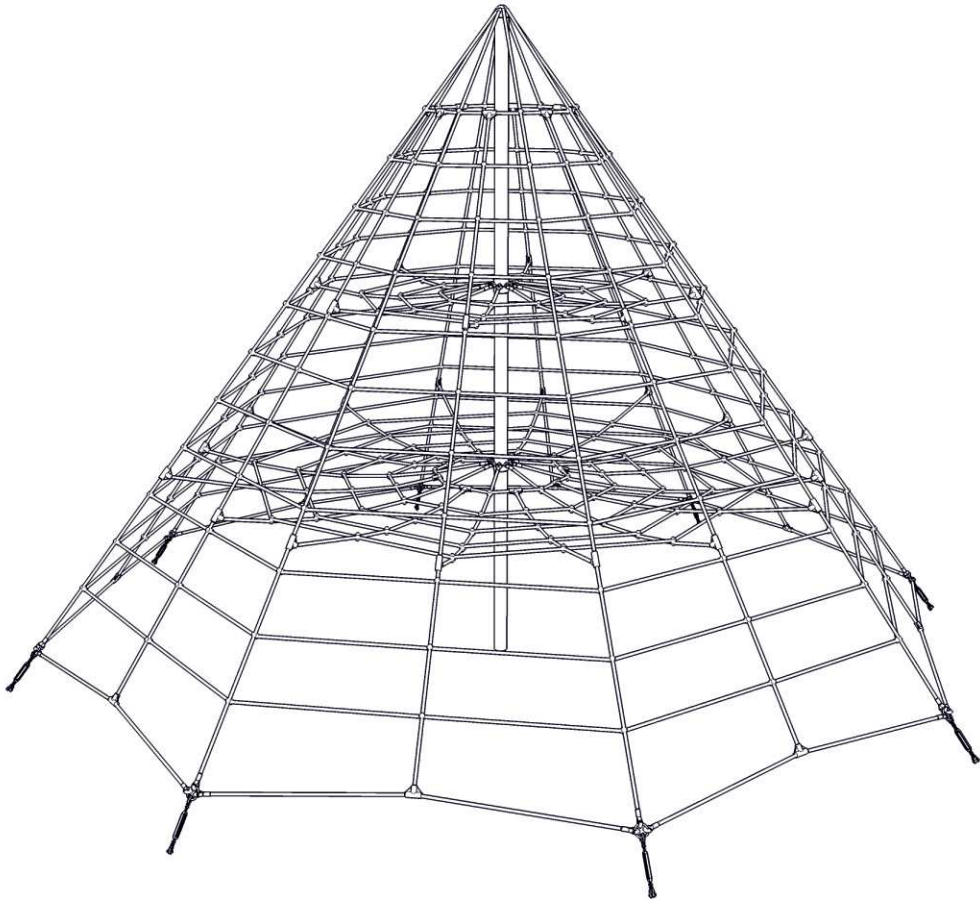

### AREA DE SEGURIDAD *safety zone*

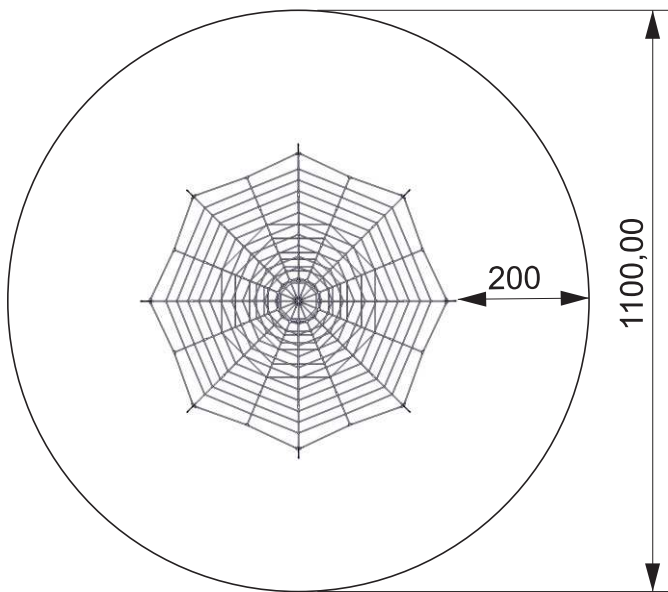

### DIMENSIONES *dimensions*

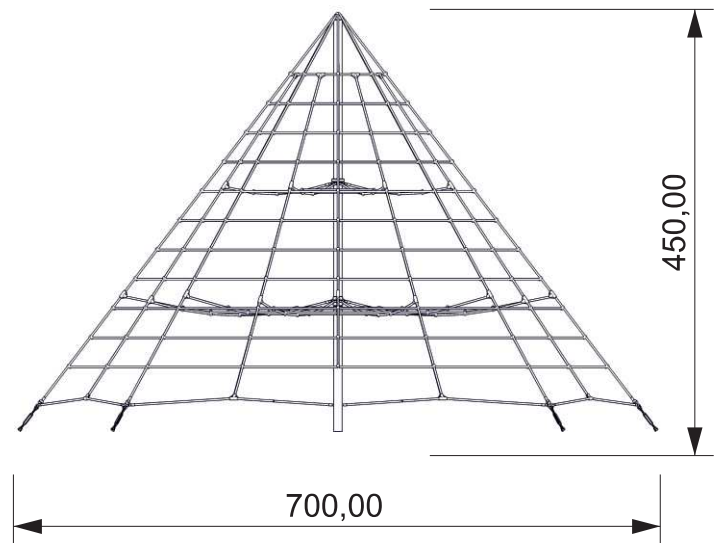

### HERRAMIENTAS *tools*

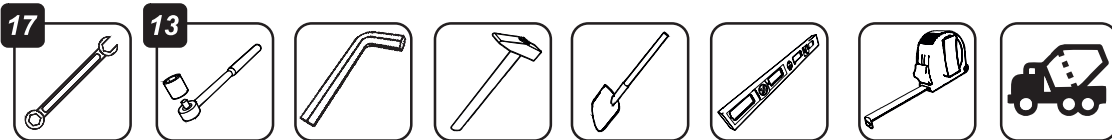

# CIMENTACIÓN

basement

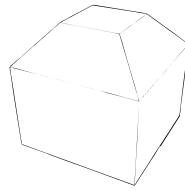

1x

60x60x60cm - 0,216 m<sup>3</sup>

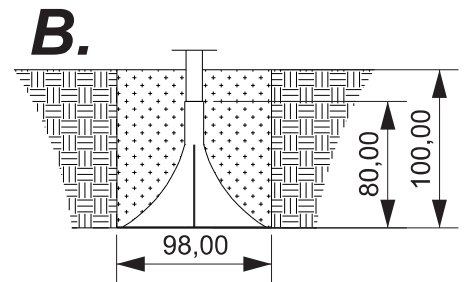
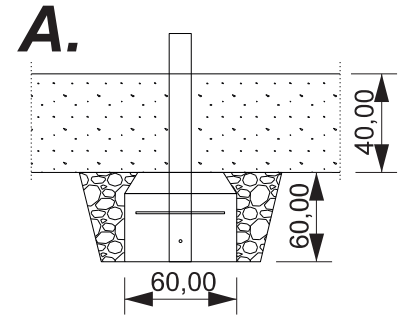
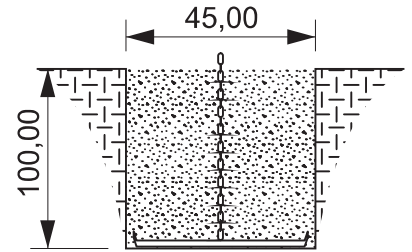
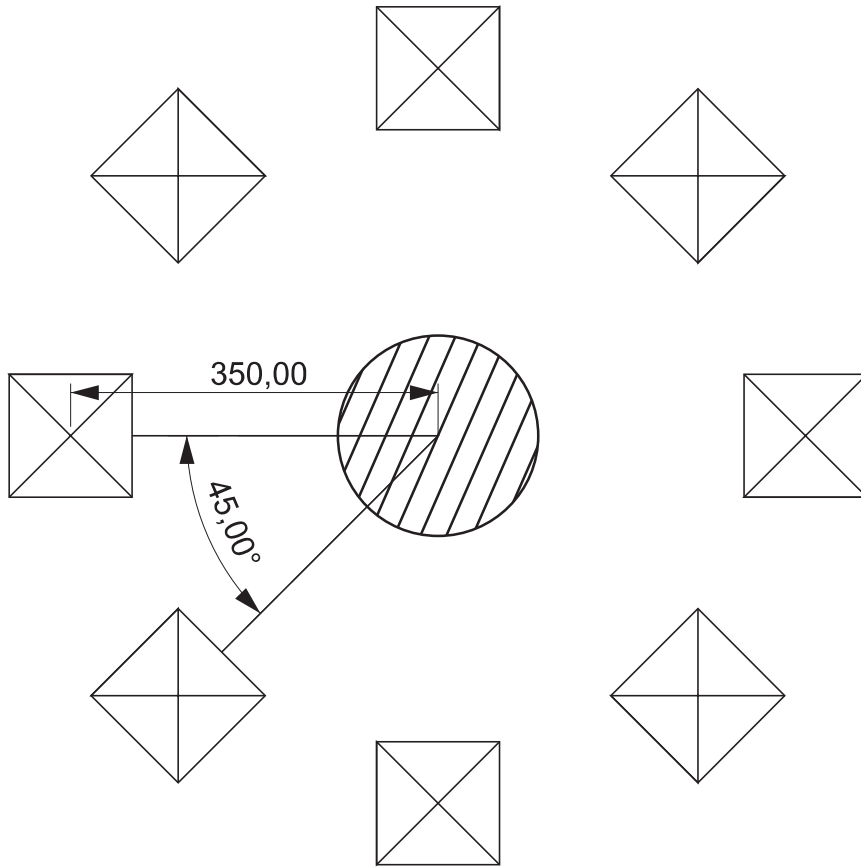

# COMPONENTES

components

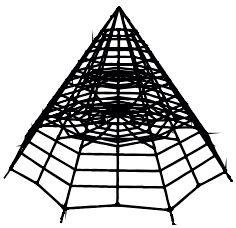

1x

1201



1x

1202



8x

1203

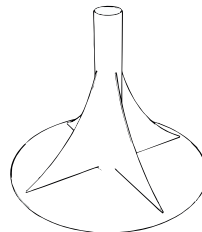

1x

1204

# A

1

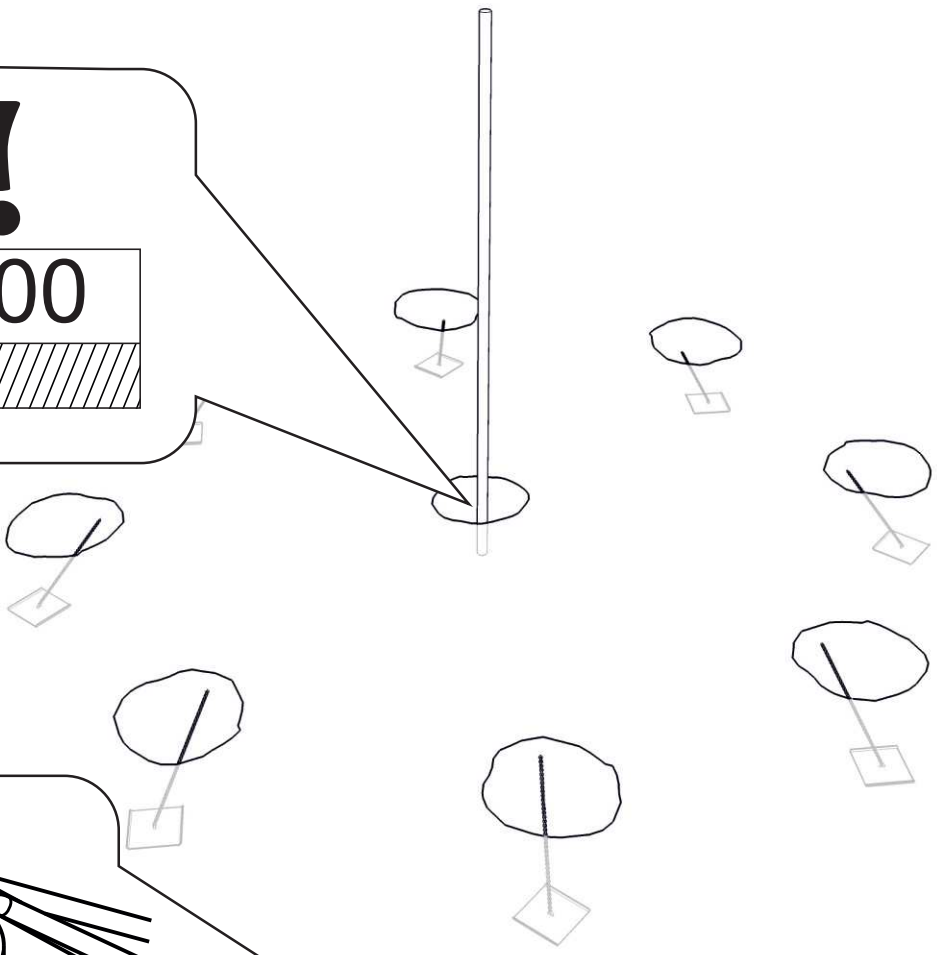

2

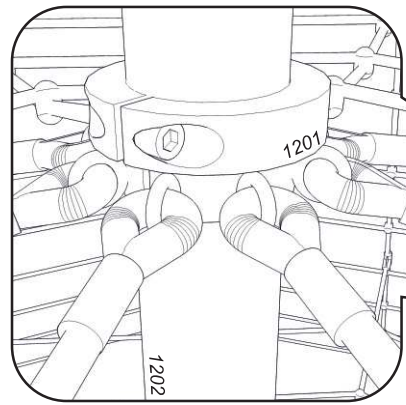
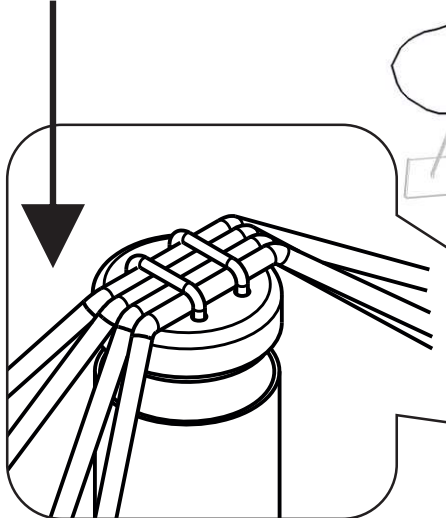

13



8x

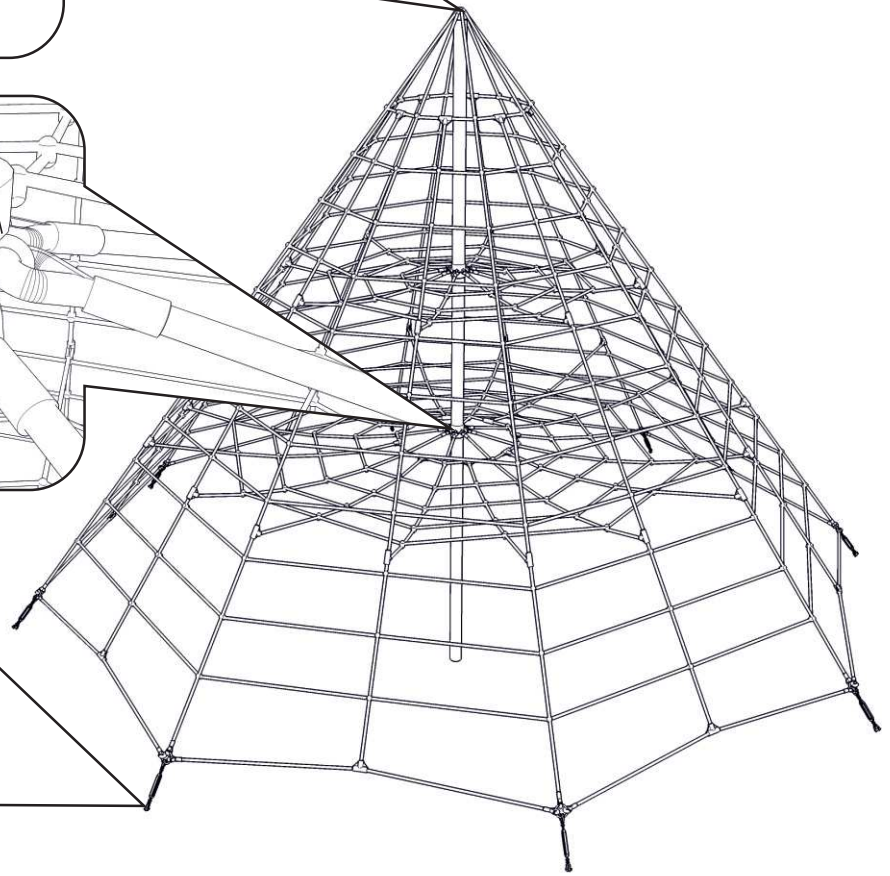
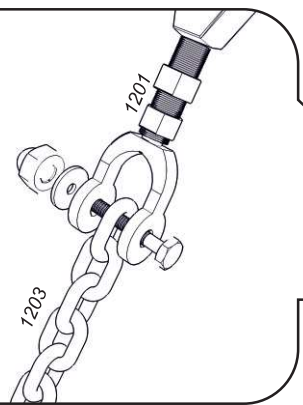

# A

3

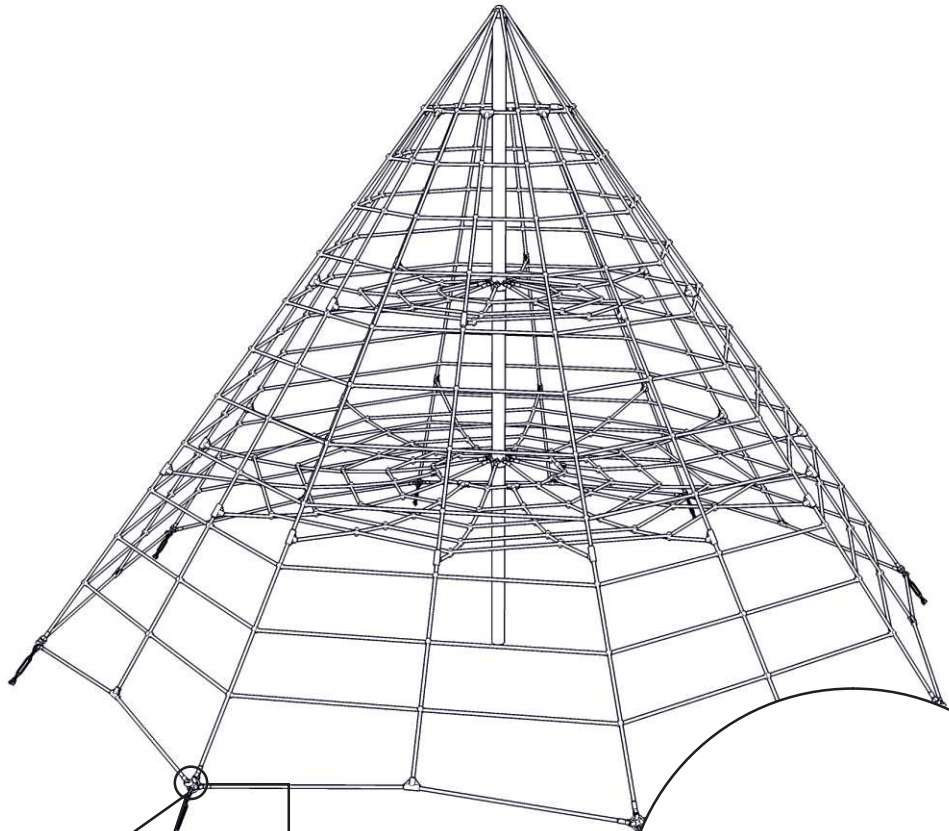

**10kN!**

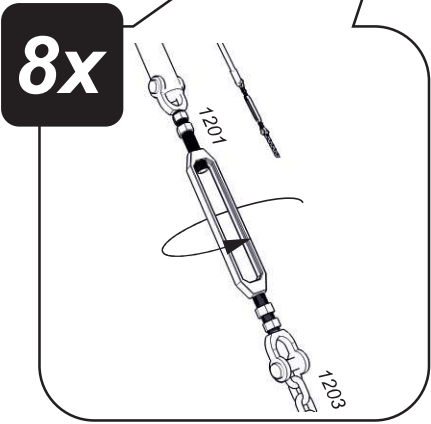

# B

1

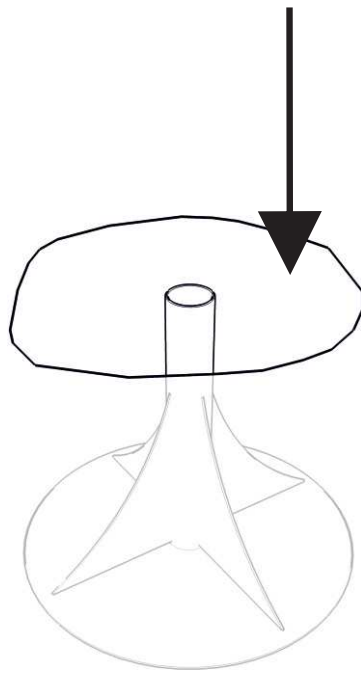

2

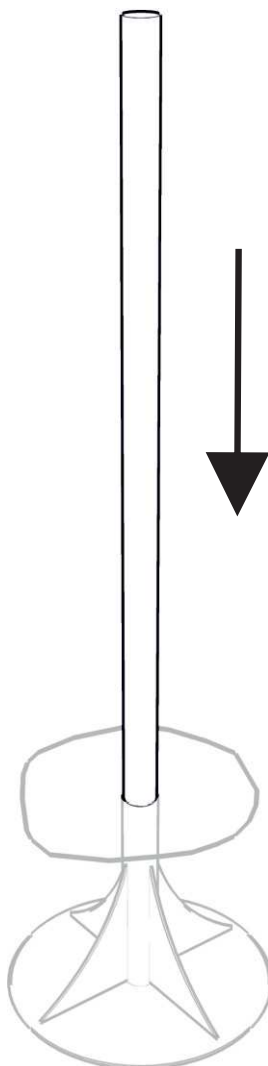
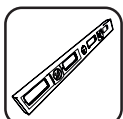



# B

3

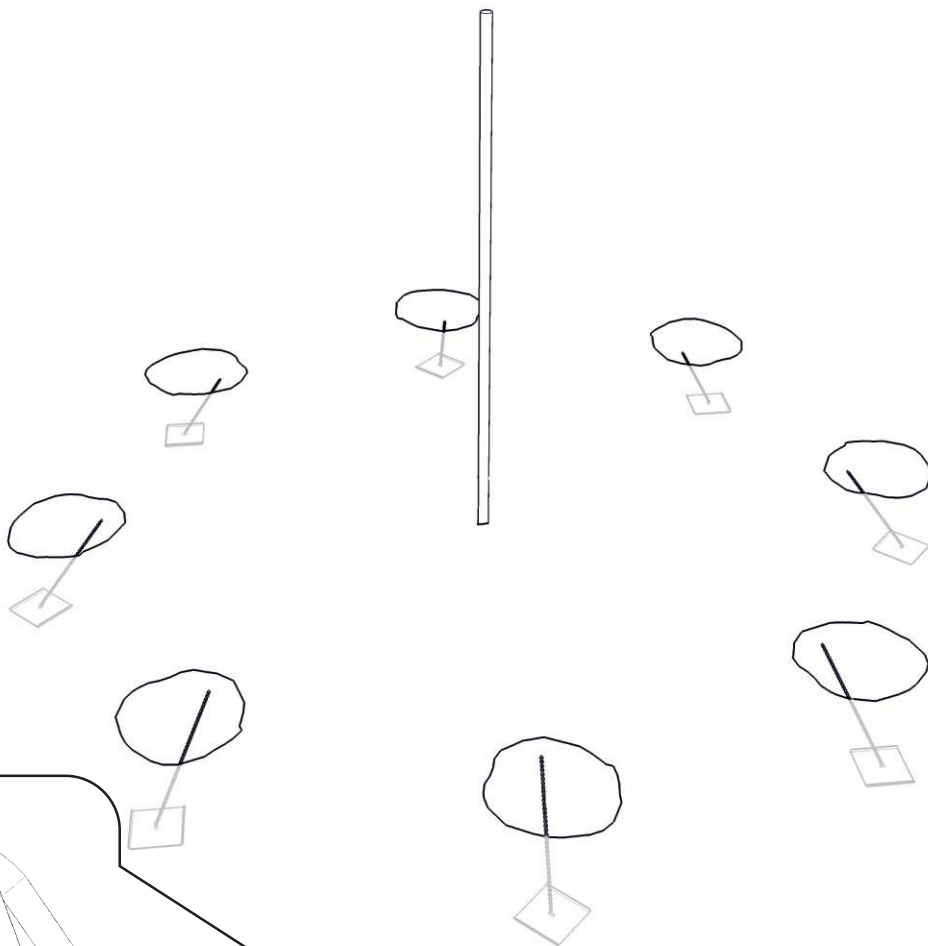

4



13

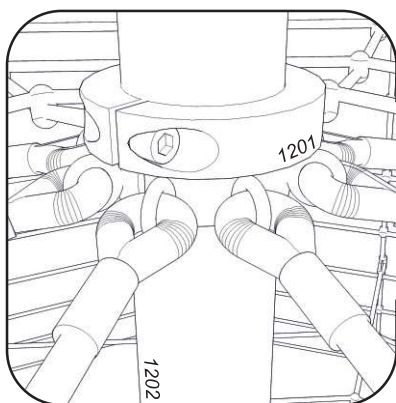
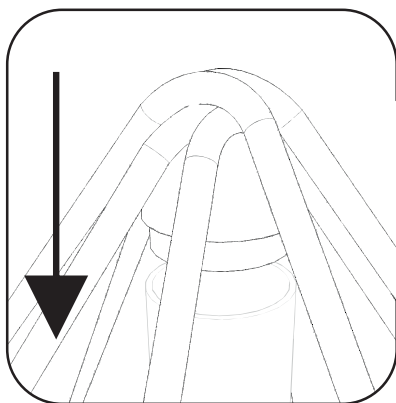

8x

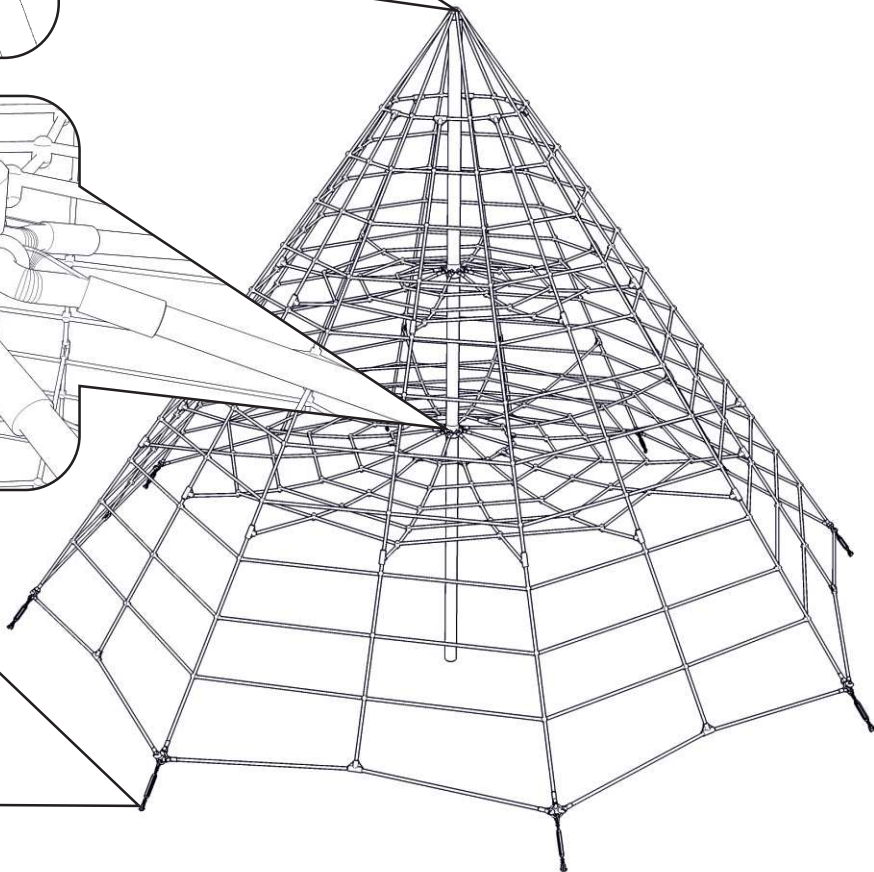
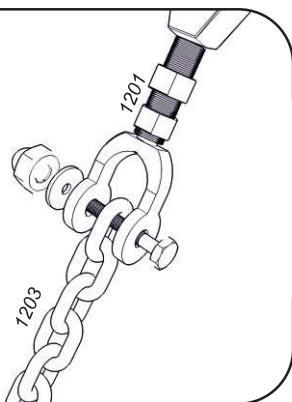

# B

5

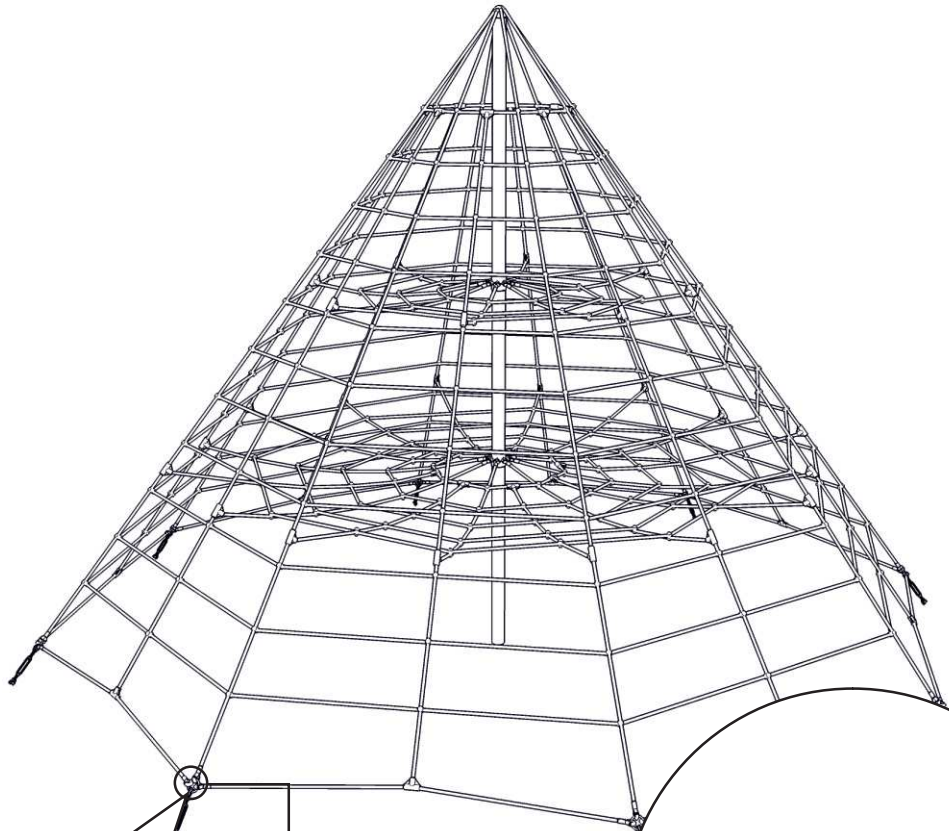

**10kN!**

