

# LEDVANCE Connected system user instruction extended version

Connected Sensor ST8 LB Gen2 / EAN 4058075232969

Connected Sensor ST8 HB Gen2 / EAN 4058075232983

ST8AU-0.6M 7,5W/840 220-240VCON / EAN 4058075187337

ST8AU-0.6M 7,5W/865 220-240VCON / EAN 4058075187351

ST8AU-1.2M 16W/840 220-240V CON / EAN 4058075187375

ST8AU-1.2M 16W/865 220-240V CON / EAN 4058075187399

ST8AU-1.5M 24W/840 220-240V CON / EAN 4058075187634

ST8AU-1.5M 24W/865 220-240V CON / EAN 4058075187658

Connected Sensor Remote / EAN 4058075374034

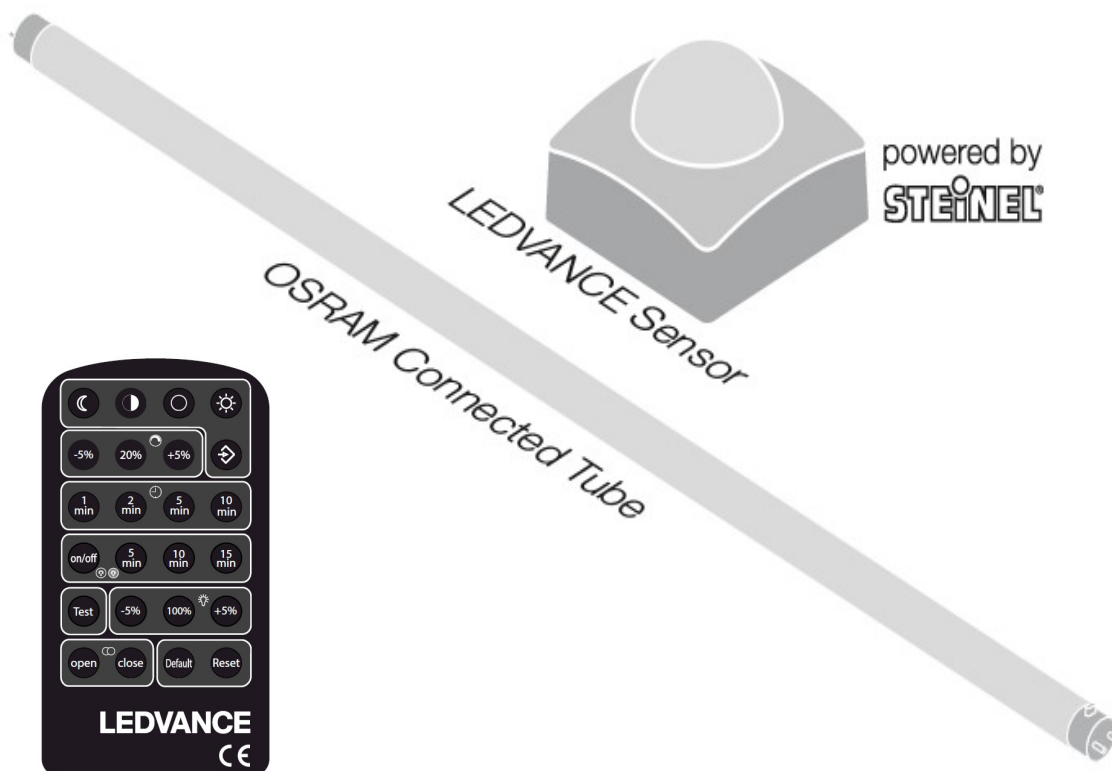

To have a connected system, please purchase both sensor and LED tube.<sup>1)</sup>

[www.ledvance.com/substitube-connected](http://www.ledvance.com/substitube-connected)

user instructions, technical details are available

# LEDVANCE Connected system user instruction extend version

## ✓ Introduction of Connected system

The connected system consists of a wireless system with external Passive Infra-Red sensors and SubstiTUBE Connected tubes. **The system can be configured directly on the sensor or by a remote control.**

The system provides illumination when vehicles or pedestrians enter a detection zone and goes back to stand-by mode when no motion is detected.

With the connected system people will experience adequate light and feel safe at reduced energy costs

## ✓ Application

Connected Sensor	
Ambient temperature	Indoor use, operation $-20^{\circ}\text{C} \dots +50^{\circ}\text{C}$
Storage temperature	Storage $-25^{\circ}\text{C} \dots +70^{\circ}\text{C}$
IP ratings	IP 54 (Indoor use)

## ✓ System overview

Communication between tubes and sensors are Zigbee 3.0 based. It is based on a 2.4 GHz **mesh communication** model using low-power devices to transmit data over long distances

## ✓ Principle of Connected system

All the tubes in the network will lighten up automatically when pedestrians or vehicles (engine heat) are detected. Duration and delay time (hold time) can be configured by installers. When pedestrians or vehicles are detected every lamp lights up to 100% or up to the configured setting.

As they move out the detection zone, every lamp dims to a level of 20% or configured set up

The installer can also configure to switch off the lamp

## ✓ Motion sensing and ambient light measurement functions

For each sensor it is possible to configure the threshold of ambient daylight level.

The primary trigger to react is given by the motion trigger.

If motion is sensed, based on the measured ambient light level, each sensor decides to switch the tubes light on or not.

## ✓ Master and Slave sensor

The factory setting of sensor is the slave mode. Once the sensor is electrified feedback red LED shows up. The assignment to be a master sensor is configured during installation of the network. First sensor you open the network will be assigned as a master sensor. **In a network only one master sensor is allowed.** After installation master and slave sensors can be identified as feedback LED color in sensors

 Master sensor feedback LED color

 Slave sensor feedback LED color

# LEDVANCE ST8 Connected sensor at a glance

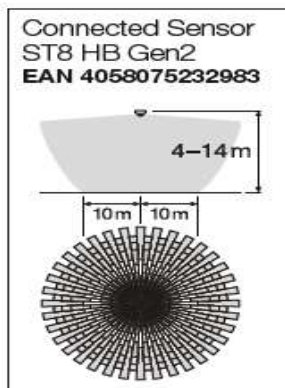
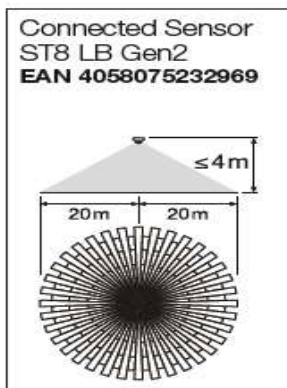
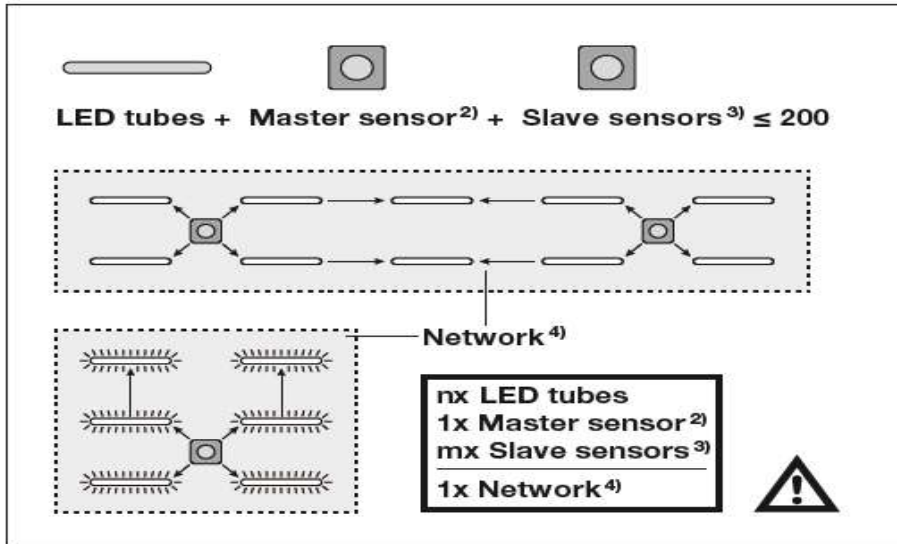

- ✓ **Can connect up to 200 devices in a network**  
1 master sensor+ m slave sensors + n LED tubes  
examples: 1 master sensor , m=20 slave sensors, n=179 tubes  
or  
1 master sensor, m=30 slave sensors, n=169 tubes  
**! only 1 master sensor is allowed in a network.**
- ✓ **Two different sensors available**  
Low bay sensor (LB) : up to 4.0m  
High bay sensor (HB): 4.0- 14.0m
- ✓ **Remote control**  
easy installation, flexible adjustment of product.
- **Important**  
**In case of several networks in the same place please wait for 3min to start next network installation : not to interfere signal between different networks.**

**Connected system needs up to 5min to reactivate all the network after power off and on. Please wait and do not touch sensor or remote control during this period.**

# Creating a network

✓ **What is a network**

the network is a group of tubes and sensors that form a connected system. It is controlled by one master sensor

All the tubes in a network will react in the same way.

If you want to have different behaviors of the tubes in one area you have to create different networks.

## One network in one area

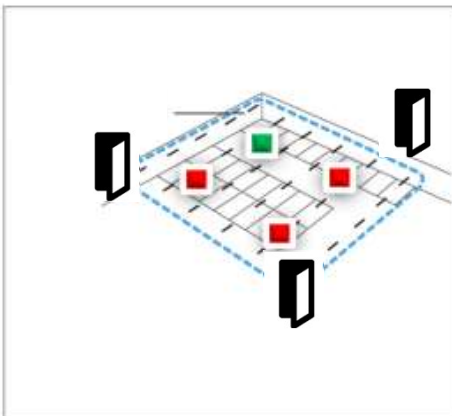

- In one network, tubes are behaving the same.
- If one of the sensor in the network is detecting the motion and ambient light is below threshold all the tubes react

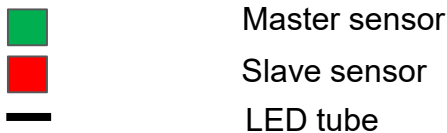

## Multi networks in one area

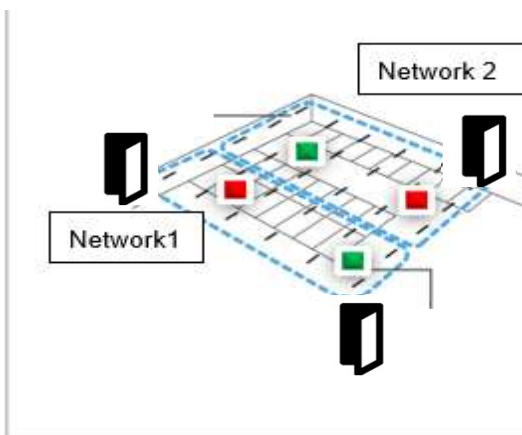

- If you want to have muti networks in one area each network has to be powered on separately during installation.
- If unpaired tubes and sensors of another intended network are powered on during the installation of the first network they may join the wrong network
- Close the pairing of network1 and wait for 3min before start pairing network 2. otherwise network 2 may join network1

## Sensor and tube installation

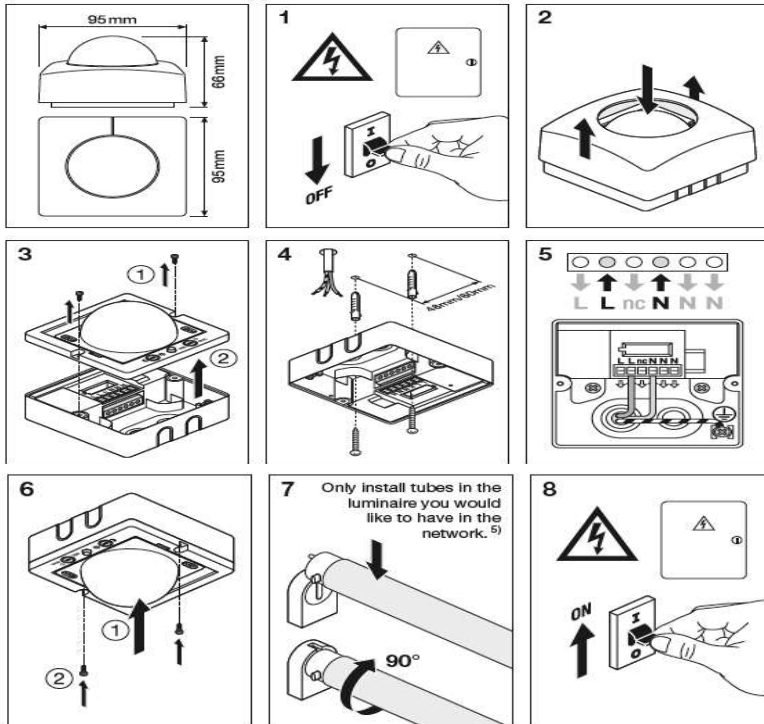

## Creating a network

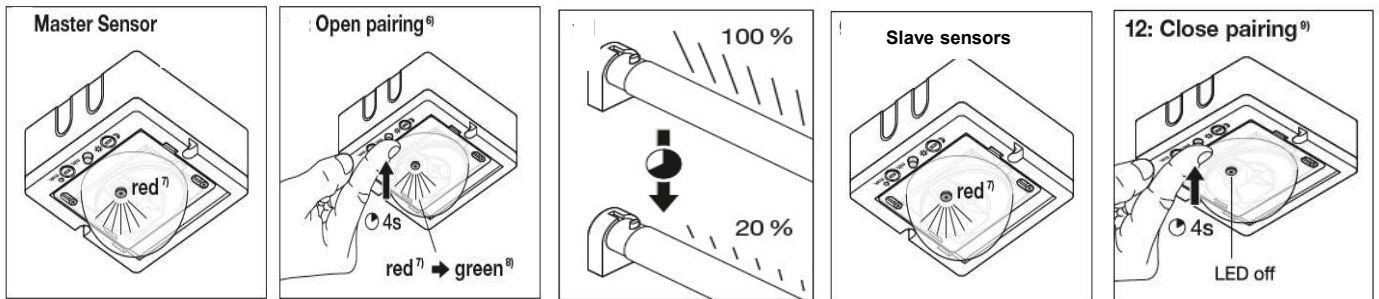

Functions	Actions	Results
<b>Open pairing (assign a master sensor)</b>	<p>Assign a master sensor. <b>First sensor you open the network will be assigned as a master sensor.</b></p> <p>Press and hold the operation button for 4 seconds</p>	<ul style="list-style-type: none"> <li>Pairing (network) is open (LED indicator color will turn from red to green and starts blinking)</li> <li>All other powered-on unpaired slave sensors will automatically paired to the new network and remain slave sensors (LED Status red blinking)</li> <li>Tubes blink and dim down to 20% as a sign of connection</li> </ul>
<b>Close pairing</b>	<p>Press and hold the operation button of master sensor for 4 seconds</p>	<ul style="list-style-type: none"> <li>Green LED blinking of master sensor stops</li> <li>Lamps dim up to 100% light</li> <li>Pairing window is closed</li> </ul>

## Test mode ( test paired tubes in a network)

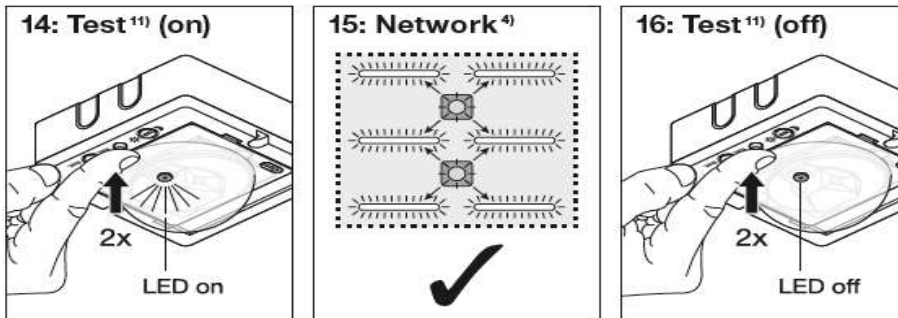

Functions	Actions	Results
Test mode on	Press operation button 2 times (short press) on any sensor	<ul style="list-style-type: none"> <li>Paired tubes and sensors will start blinking continuously to identify which tubes and sensors are paired within the network</li> </ul>
Test mode off	Press again operation button 2 times (short press)	<ul style="list-style-type: none"> <li>Paired tubes and sensors stop blinking, end of test mode</li> </ul>

## Potentiometer functions

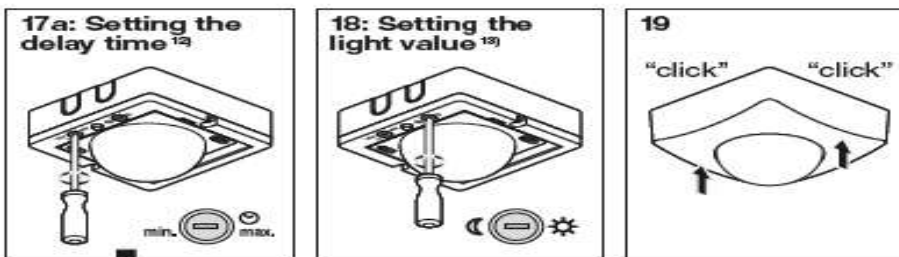

Functions	Actions	Results
17a : time delay potentiometer	Functional at master sensor only	<ul style="list-style-type: none"> <li>The chosen light on: delay time can be varied continuously from approx. 1min to a maximum of 10 min. <u>Any movement detected before time elapses will re-start the timer</u></li> </ul>
18 daylight potentiometer	Functional at master and slave sensor	<ul style="list-style-type: none"> <li>desired response threshold of the light can be infinitely adjusted from approx.2 – 1000 lux.</li> <li>Turn control fully anticlockwise to select night-time operation at about 2 lux (Moon)</li> <li>Turn control fully clockwise to the Sun position means daylight operation at about 1000 lux (Sun)</li> </ul>

## Stand by mode and lamp off mode

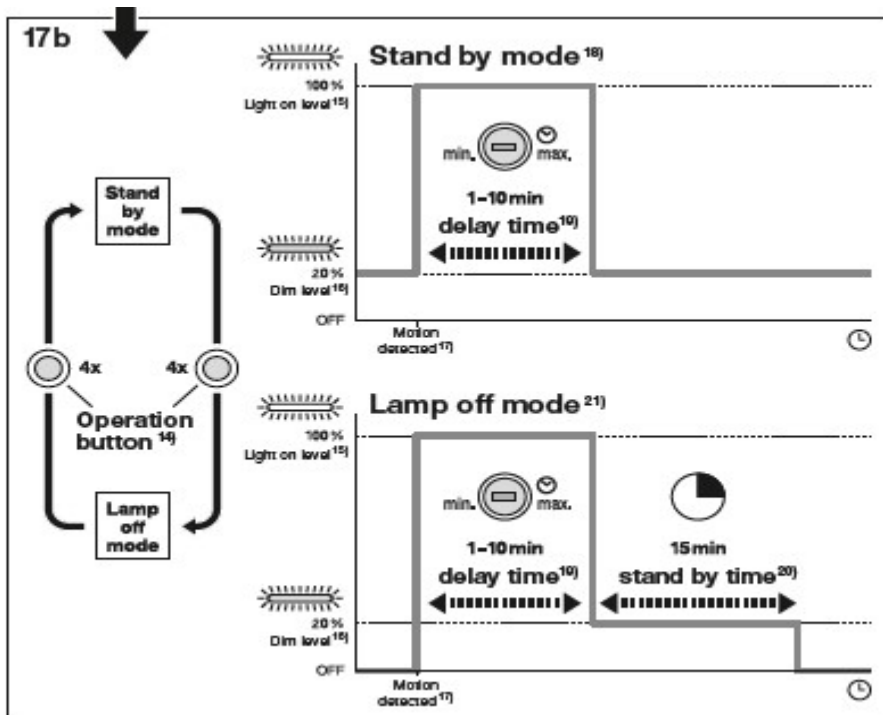

Functions	Actions
<b>Motion detected</b>	The sensor detects motion and tubes go up at the maximum light 100%
<b>Stand by mode</b>	The sensor doesn't detect movement and after the delay time elapses (1-10min) tubes dim down to 20% dim level. Tubes always stay at 20% dim level when motion is not detected.
<b>Lamp off mode</b>	The sensor doesn't detect movement and after the delay time elapses (1-10min) tubes dim down to 20% dim level. The system will start stand by timer and after elapsing (15min) tubes switch off

## Reset

Functions	Actions	Results
<b>Reset 1</b>	Press operation button on master sensor 10times	All devices will be set to factory settings and the whole network will be unpaired. <ul style="list-style-type: none"> <li>• Feedback of sensors will have permanent red LED</li> </ul>
<b>Reset 2</b> <b>Only needed if master sensor is broken</b>	Press any slave sensor in a network and press operation button for 15 seconds	<ul style="list-style-type: none"> <li>• After blinking all the tubes in the network will turn to 100% light level.</li> <li>• This process will take minimum 30 seconds</li> </ul>

## Adding a new lamp into the network

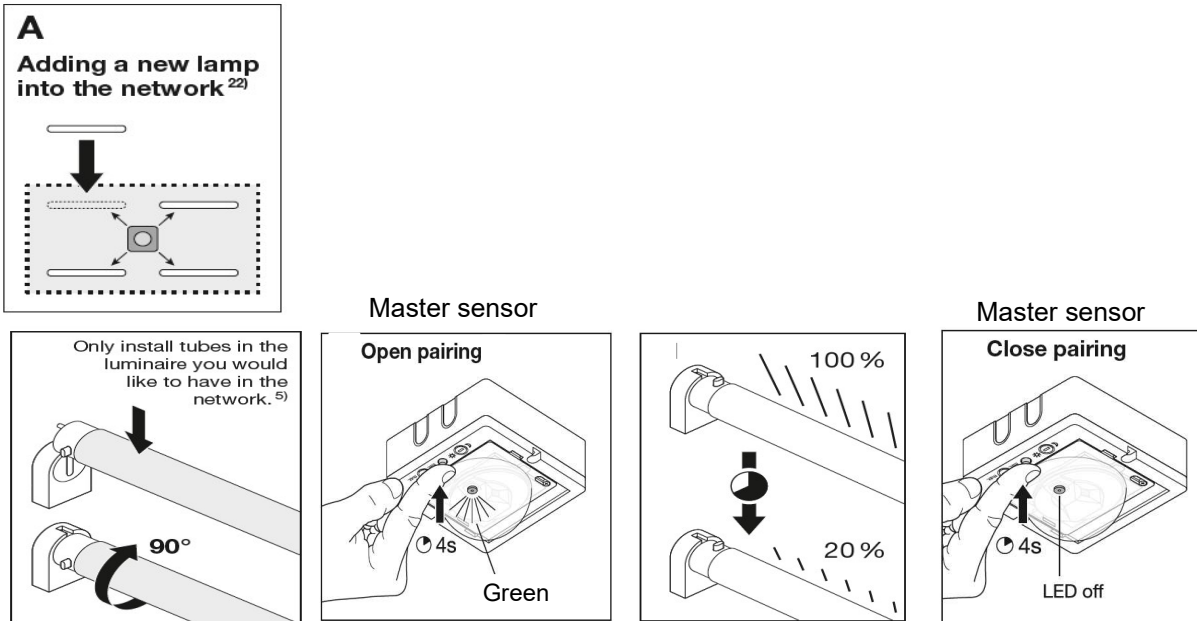

## Adding a sensor into the network

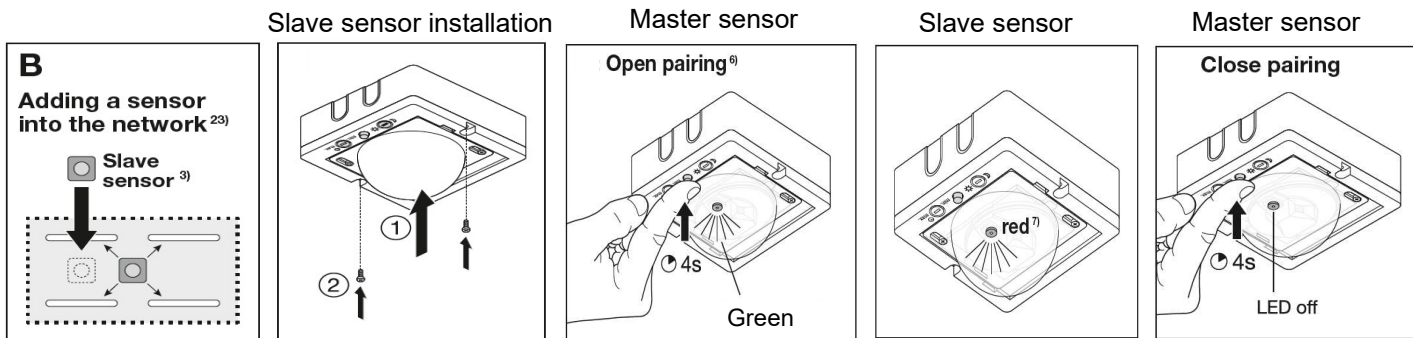

## Removing a sensor from the network

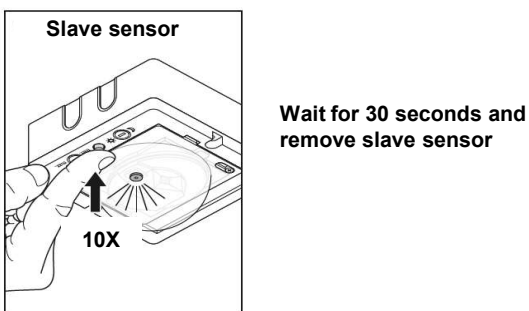

## Removing a tube from the network

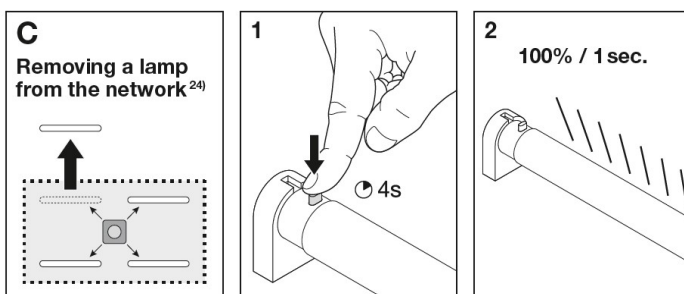



# FAQ

functions	Actions	Results									
Sensor mounting location	at least 50 cm away from other lights because heat radiated from these may activate system.										
What is max. allowed distance between sensor and tube	15m free air	Close luminaire, cornerstone, airconditioner, heater within this distance may shorten the distance									
What is max. allowed distance between sensor and tube	15m free air	Close luminaire, cornerstone, airconditioner, heater within this distance may shorten the distance									
Master sensor is broken	Please go to any slave sensor and press and hold for 15 seconds.	This destroys the pairing of the group (delete network) and all devices go back to factory settings									
Stop overruling the potentiometers by the remote control	Press operation button of master or slave sensor 6 times (short)	The read values from the Daylight and Delay potentiometers are used again									
Power off -> on	Please wait for 5min to reactivate system. Network will be reconnected automatically. <b>Please do not touch operation button or pairing button on the remote controller</b>	Connected system needs up to 5min to reactivate all the network after power off and on. It is very similar to WIFI router									
Compatibility between Gen1 and Gen2 system	<table border="1"> <thead> <tr> <th></th> <th>Gen1 sensor</th> <th>Gen2 sensor</th> </tr> </thead> <tbody> <tr> <td>Gen1 Tube</td> <td>Yes</td> <td>Yes</td> </tr> <tr> <td>Gen2 Tube</td> <td>Yes</td> <td>Yes</td> </tr> </tbody> </table>		Gen1 sensor	Gen2 sensor	Gen1 Tube	Yes	Yes	Gen2 Tube	Yes	Yes	Gen2 tube with Gen1 sensor will still have same function like Gen1 system. Master and slave functions are not possible.
	Gen1 sensor	Gen2 sensor									
Gen1 Tube	Yes	Yes									
Gen2 Tube	Yes	Yes									
How i recognize master sensor and slave sensor after installation	If you go to detection zone : <ul style="list-style-type: none"> <li>• Master sensor: green LED feedback</li> <li>• Slave sensor: red LED feedback</li> </ul>										