

# PRODUCT DATASHEET

## BIOLUX HCL DL DN150 ZB 20W 2700-6500K

BIOLUX HCL DOWNLIGHT ZIGBEE | Downlight luminaires, Tunable White, Zigbee



### Areas of application

- Lighting solution for up to 40 BIOLUX HCL luminaires - BIOLUX HCL LED strips combined mit BIOLUX HCL control unit
- Open-plan office solution for up to 200 BIOLUX HCL luminaires combined with VIVARES ZIGBEE control unit
- Hotel and office rooms with little daylight

### Product benefits

- Enables an individual lighting solution in combination with compatible Zigbee HCL lighting controls
- Biologically optimized lighting by adapting artificial light to natural daylight course
- 5 years BIOLUX HCL system guarantee when operated as part of a BIOLUX HCL system (BIOLUX HCL- - VIVARES ZIGBEE control unit in combination with BIOLUX HCL luminaire(s) - BIOLUX HCL LED strips)
- Can support working with more concentration
- Good glare reduction ( $UGR \leq 19$ )

### Product features

- Zigbee 3.0 certified Tunable White luminaires - LED strips for simple integration into partner systems
- Ready for connection to BIOLUX HCL and VIVARES ZIGBEE control unit
- Adjustable color temperature via Tunable White: 2,700...6,500 K
- Wireless communication between control unit and luminaries via Zigbee protocol
- Very high color rendering index  $R_a > 90$



## TECHNICAL DATA

### Electrical data

Nominal wattage	20.00 W
Nominal voltage	220...240 V
Mains frequency	50...60 Hz
Nominal current	93 mA
Inrush current	20 A
Inrush current time $T_{h50}$	500 $\mu$ s
Max. no. of lum. on circuit break. B16 A	128
Max. no. of lum. on circuit break. C10 A	80
Max. no. of lum. on circuit break. C16 A	128
Power factor $\lambda$	$\geq 0.90$
Total harmonic distortion	< 20 %
Protection class	II
Operating mode	External LED driver

### Photometrical data

Luminous flux	1800 lm
Luminous efficacy	90 lm/W
Color temperature	2700...6500 K
Light color (designation)	Warm White / Cool White / Cool Daylight
Color rendering index Ra	> 90
Standard deviation of color matching	$\leq 3$ sdc <sub>m</sub>
Luminous intensity	-
Low flicker	Yes
Flickering metric (Pst LM)	-
Stroboscope effect metric (SVM)	-
Photobiological safety group acc. to EN62778	RG1
Beam angle	60 °
UGR	< 19

### Dimensions & Weight

Diameter	175.40 mm
Height	98.90 mm
Product weight	550.00 g

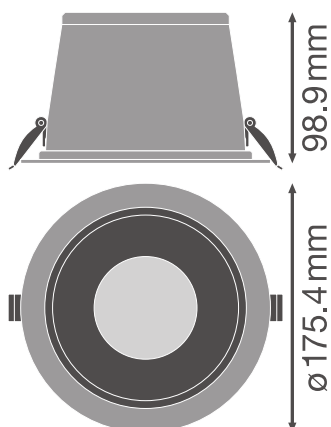

### Materials & Colors

Product color	White
Housing color	White
Body material	Aluminum
Cover material	Polycarbonate (PC)
Light emitting surface material	PMMA
Glow Wire Test according to IEC 60695-2-12	850 °C
Mercury content	0.0 mg

### Application & Mounting

Ambient temperature range	-20...+40 °C
Type of connection	Terminal, 3-Pole (L, N, PE)
Type of protection	IP20
Protection class IK (shock resistance)	IK03
Dimmable	Yes
Type of dimming	ZIGBEE
Mounting type	Recessed
Mounting location	Ceiling
Application environment	Indoor
Mounting depth	150 mm
LED module replaceable	Not replaceable
With light source	Yes

### Lifespan

Lifespan L70/B50 at 25 °C	50000 h
Lifespan L80/B10 at 25 °C	40000 h
Lifespan L90/B10 at 25 °C	25000 h
Number of switching cycles	50000

### Certificates & Standards

Standards	CE / CB / ENEC / EAC
Luminaire with limited surface temperature, "D sign"	No
Ball shot safe	No







### EQUIPMENT / ACCESSORIES















- LEDVANCE BIOLUX app required for commissioning of the BIOLUX HCL system only (available for Android and iOS)
- LEDVANCE VIVARES app for project planning and required for commissioning of the VIVARES ZIGBEE system only (available for Android and iOS)

### Safety advice

- Important operating notice and legal disclaimer: This product is exclusively intended for operation as part of a BIOLUX HCL system (BIOLUX HCL- or VIVARES ZIGBEE control unit in combination with BIOLUX HCL-Luminaire(s) / BIOLUX HCL LED strips including built-in or supplied firmware/software). LEDVANCE GmbH assumes no responsibility, liability, warranty or guarantee for the operation of the product in combination or conjunction with third-party products or other products that are not BIOLUX HCL- / VIVARES ZIGBEE system products.

### DOWNLOAD DATA

DOWNLOAD DATA	
	User instruction
	Addon Technical Information
	Tender documents
	Tender documents
	Certificates
	Certificates
	Certificates

DOWNLOAD DATA	
	Declarations of conformity
	Installation guide
	Installation guide
	Installation guide
	IES file (IES)
	IES files (IES, additional)
	IES files (IES, additional)
	LDT file (Eulumdat)
	LDT files (Eulumdat, additional)
	LDT files (Eulumdat, additional)
	R3D file (Relux 3D Model)
	M3D file (3D Model)
	ULD file (DIALux)
	Packaging insert

LOGISTICAL DATA

Product code	Packaging unit (Pieces/Unit)	Dimensions (length x width x height)	Gross weight	Volume
4058075400740	Shipping box 4	397 mm x 207 mm x 308 mm	3175.00 g	25.31 dm <sup>3</sup>

The mentioned product code describes the smallest quantity unit which can be ordered. One shipping unit can contain one or more single products. When placing an order, for the quantity please enter single or multiples of a shipping unit.

## References / Links

- For Guarantee see [www.ledvance.com/guarantee](http://www.ledvance.com/guarantee)
- 

## Legal advice

- The use of the LEDVANCE BIOLUX- / VIVARES-app is exclusively subject to the LEDVANCE BIOLUX- - VIVARES-app Terms of Use, which are displayed during installation of the app and are available in the app
- 

## DISCLAIMER

Subject to change without notice. Errors and omission excepted. Always make sure to use the most recent release.