

LED STRIP PERFORMANCE

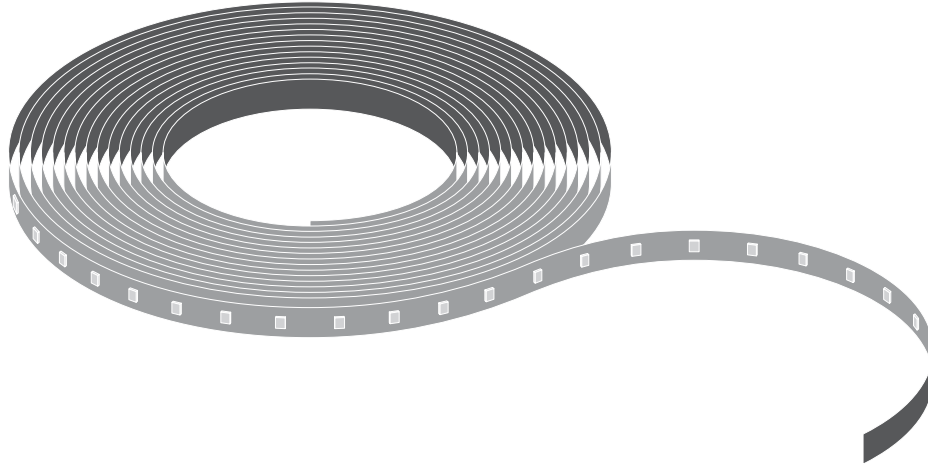

| | EAN | l x w x h [mm] | V _{DC} | W | W/m | lm | lm/m | lm/W | K | ⊖ (°C) | ∇ | R _a |
|-----------------|---------------|----------------|-----------------|----|------|------|------|------|------|-----------|------|----------------|
| LS P-500/927/5 | 4058075707474 | 5000 x 8 x 1.5 | 24V | 21 | 4.2 | 2265 | 505 | 120 | 2700 | -20...+55 | 120° | >90 |
| LS P-500/930/5 | 4058075707498 | 5000 x 8 x 1.5 | 24V | 21 | 4.2 | 2310 | 515 | 122 | 3000 | -20...+55 | 120° | >90 |
| LS P-500/940/5 | 4058075707511 | 5000 x 8 x 1.5 | 24V | 21 | 4.2 | 2455 | 545 | 130 | 4000 | -20...+55 | 120° | >90 |
| LS P-500/965/5 | 4058075707535 | 5000 x 8 x 1.5 | 24V | 21 | 4.2 | 2455 | 545 | 130 | 6500 | -20...+55 | 120° | >90 |
| LS P-1000/927/5 | 4058075707559 | 5000 x 8 x 1.5 | 24V | 43 | 8.6 | 4645 | 1010 | 118 | 2700 | -20...+55 | 120° | >90 |
| LS P-1000/930/5 | 4058075707573 | 5000 x 8 x 1.5 | 24V | 43 | 8.6 | 4730 | 1030 | 120 | 3000 | -20...+55 | 120° | >90 |
| LS P-1000/940/5 | 4058075707597 | 5000 x 8 x 1.5 | 24V | 43 | 8.6 | 5030 | 1090 | 127 | 4000 | -20...+55 | 120° | >90 |
| LS P-1000/965/5 | 4058075707610 | 5000 x 8 x 1.5 | 24V | 43 | 8.6 | 5030 | 1090 | 127 | 6500 | -20...+55 | 120° | >90 |
| LS P-1500/927/5 | 4058075707634 | 5000 x 8 x 1.5 | 24V | 60 | 12 | 6480 | 1435 | 119 | 2700 | -20...+55 | 120° | >90 |
| LS P-1500/930/5 | 4058075707658 | 5000 x 8 x 1.5 | 24V | 60 | 12 | 6600 | 1455 | 121 | 3000 | -20...+55 | 120° | >90 |
| LS P-1500/940/5 | 4058075707672 | 5000 x 8 x 1.5 | 24V | 60 | 12 | 7020 | 1550 | 129 | 4000 | -20...+55 | 120° | >90 |
| LS P-1500/965/5 | 4058075707696 | 5000 x 8 x 1.5 | 24V | 60 | 12 | 7020 | 1550 | 129 | 6500 | -20...+55 | 120° | >90 |
| LS P-2000/927/5 | 4058075707719 | 5000 x 8 x 1.5 | 24V | 78 | 15.6 | 8420 | 1840 | 118 | 2700 | -20...+55 | 120° | >90 |
| LS P-2000/930/5 | 4058075707733 | 5000 x 8 x 1.5 | 24V | 78 | 15.6 | 8580 | 1870 | 120 | 3000 | -20...+55 | 120° | >90 |
| LS P-2000/940/5 | 4058075707757 | 5000 x 8 x 1.5 | 24V | 78 | 15.6 | 9125 | 1980 | 127 | 4000 | -20...+55 | 120° | >90 |
| LS P-2000/965/5 | 4058075707771 | 5000 x 8 x 1.5 | 24V | 78 | 15.6 | 9125 | 1980 | 127 | 6500 | -20...+55 | 120° | >90 |

| Length of supply wire (0,5 mm ² wire cross-section)* | Max. meters of LED STRIP at T _a =25°C** | | | | |
|---|--|-----|-----|-----|-----|
| | <0.5m | 1m | 3m | 6m | 10m |
| LS P-500/9xx/5 IP00 | 10.1 | 9.8 | 9.4 | 8.8 | 7.9 |
| LS P-1000/9xx/5 IP00 | 8.5 | 8.3 | 7.9 | 7.3 | 6.3 |
| LS P-1500/9xx/5 IP00 | 7.3 | 7.0 | 6.6 | 6.1 | 5.3 |
| LS P-2000/9xx/5 IP00 | 6.0 | 5.7 | 5.3 | 4.7 | 4.0 |

**NOT FOR PRINT
PRODUCTION!**

WARNING:

This PDF file is for reference only and not to be used for the creation of production art. Colour printouts and screen displays should not be used for colour approval as colours may vary from device to device. The colour values for this file are defined in either Pantone (PMS), HKS, or in process colours (CMYK). For obtaining hard-copies in actual size (1:1) you need to enter the proper settings in your printer options.

本品不可印刷生产

警告:

本PDF文档仅作为参照文件，不能将本档用于印刷生产或者制作菲林。本档的色彩打印版本或在电脑屏幕中显示的色彩，不可用于最终的色彩参照。因为硬件或设备的差异，可能造成色彩的偏差。最终正式的色彩谱遵照由色板卡片PMS、HKS或者CMYK(青红黄黑)所定义的色彩。若本档的打印件要获取1:1的原始尺寸，须在打印选项中作出相应的设置。

NOT FOR PRINT PRODUCTION!

WARNING:

This PDF file is for reference only and not to be used for the creation of production art. Colour printouts and screen displays should not be used for colour approval as colours may vary from device to device. The colour values for this file are defined in either Pantone (PMS), HKS, or in process colours (CMYK). For obtaining hard-copies in actual size (1:1) you need to enter the proper settings in your printer options.

本品不可印刷生产

警告: 本PDF文档仅作为参考文件, 不能将本档用于印刷生产或者制作菲林。本档的色彩打印版本或在电脑屏幕中显示的色彩, 不可用于最终的色彩参照。因为硬件或设备的差异, 可能造成色彩的偏差。最终正式的色彩请遵照由色板卡片PMS、HKS或者CMYK(青红黄黑)所定义的色彩。若本档的打印件要获取1:1的原始尺寸, 须在打印选项中作出相应的设置。



LED STRIP PERFORMANCE

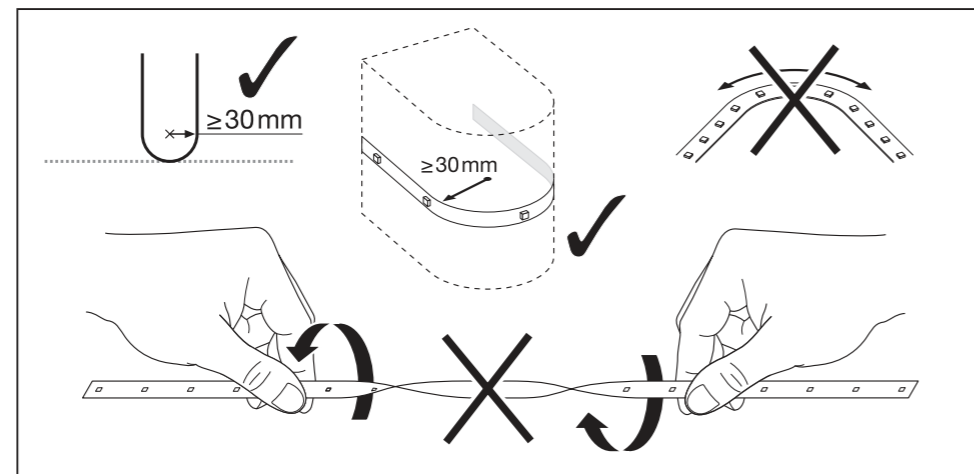
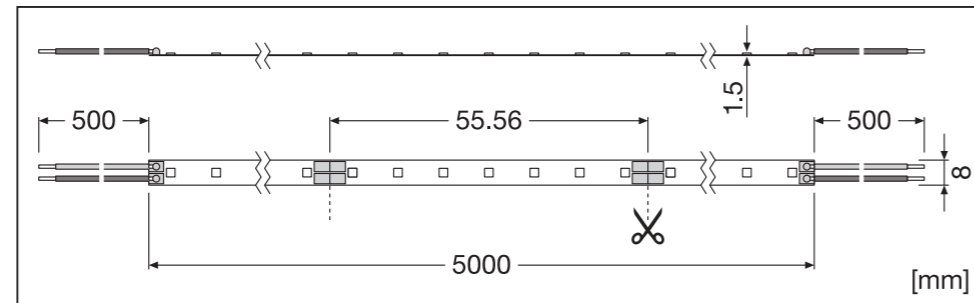

A

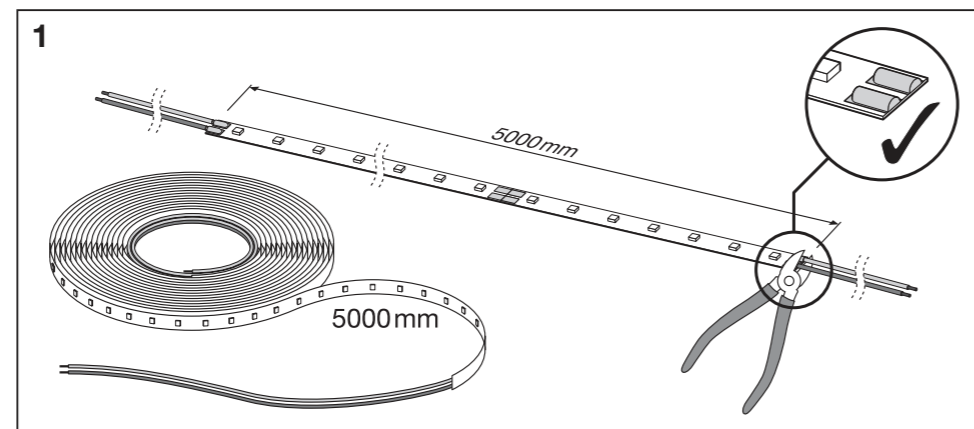

2

LED STRIP PERFORMANCE

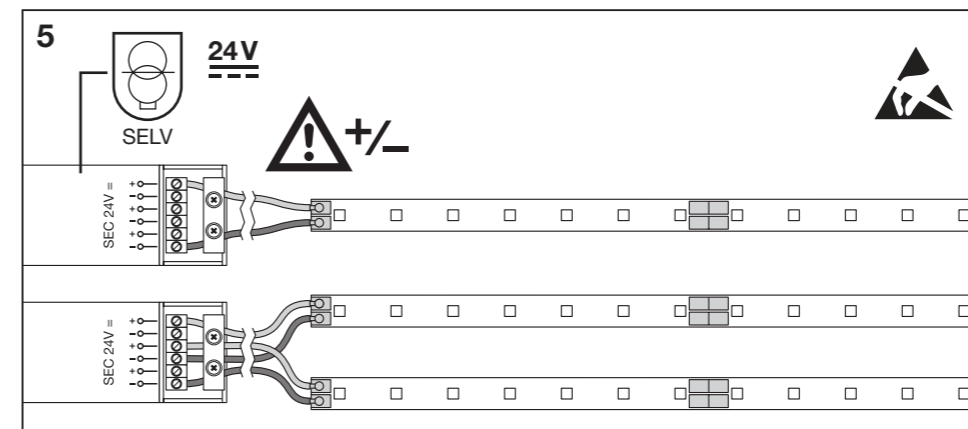
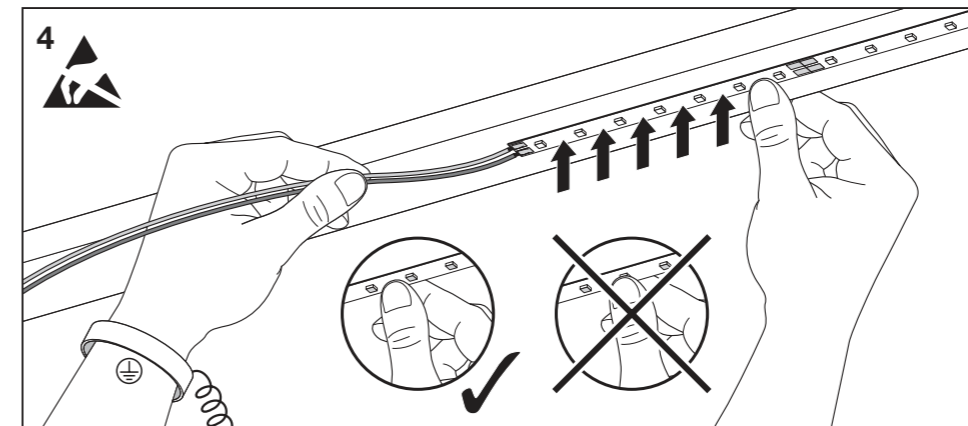
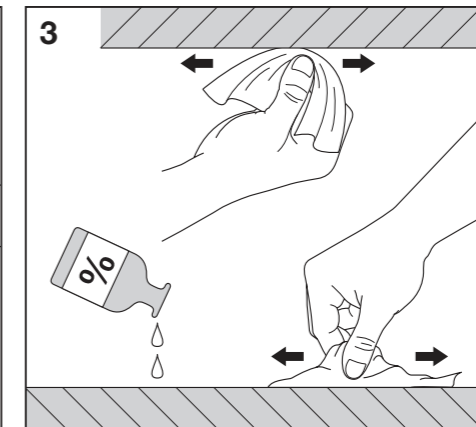
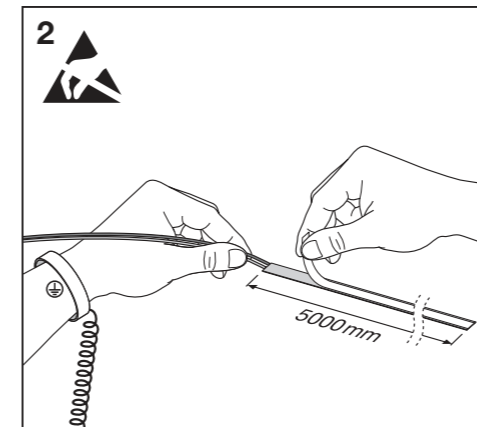

3

NOT FOR PRINT PRODUCTION!

WARNING:

This PDF file is for reference only and not to be used for the creation of production art. Colour printouts and screen displays should not be used for colour approval as colours may vary from device to device. The colour values for this file are defined in either Pantone (PMS), HKS, or in process colours (CMYK). For obtaining hard-copies in actual size (1:1) you need to enter the proper settings in your printer options.

本品不可印刷生产

警告:
本PDF文档仅作为参考文件，不能将本档用于印刷生产或者制作菲林。本档的色彩打印版本或在电脑屏幕中显示的色彩，不可用于最终的色彩参照。因为硬件或设备的差异，可能造成色彩的偏差。最终正式的色彩请遵照色板卡片PMS、HKS或者CMYK(青红黄黑)所定义的色彩。若本档的打印件要获取1:1的原始尺寸，须在打印选项中作出相应的设置。



LED STRIP PERFORMANCE

B

LS AY-CP/P2/500
EAN:4058075727403

LS AY-CSD/P2
EAN:4058075727526

1

2

3a

3b

4

4

#27402
black
score dimension 148 x 210 mm



LED STRIP PERFORMANCE

C

1

2

3

4

5

#27402
black
score dimension 148 x 210 mm

