

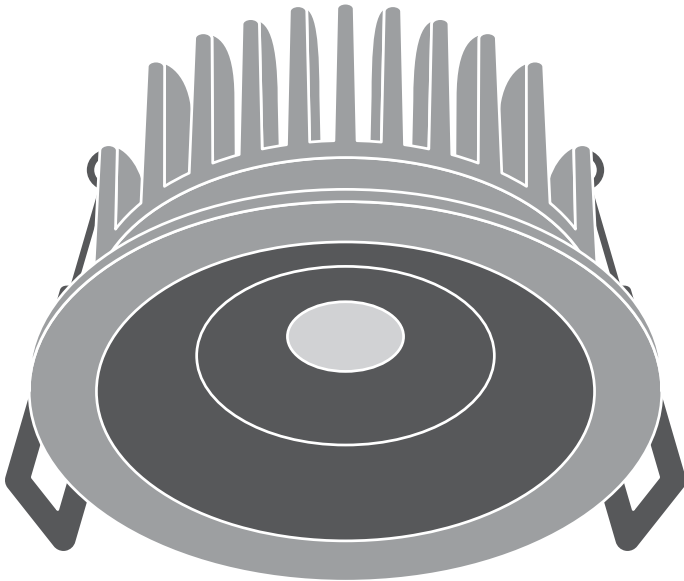





SPOT FIX
SPOT ADJUST



	EAN	W	Hz	PF	lm	lm/W	K	R _a	
SP FIX P 8W 927 PS DIM IP44 WT	4058075799523	8	50/60 Hz	> 0.9	640	80	2700	90	36°
SP FIX P 8W 930 PS DIM IP44 WT	4058075799547	8	50/60 Hz	> 0.9	680	85	3000	90	36°
SP FIX P 8W 940 PS DIM IP44 WT	4058075799561	8	50/60 Hz	> 0.9	720	90	4000	90	36°
SP FIX P 8W 927 PS DIM IP44 BK	4099854000126	8	50/60 Hz	> 0.9	640	80	2700	90	36°
SP FIX P 8W 930 PS DIM IP44 BK	4058075799585	8	50/60 Hz	> 0.9	680	85	3000	90	36°
SP FIX P 8W 930 PS DIM IP44 SI	4058075799608	8	50/60 Hz	> 0.9	680	85	3000	90	36°
SP ADJ P 8W 927 PS DIM IP20 WT	4058075799622	8	50/60 Hz	> 0.9	640	80	2700	90	36°
SP ADJ P 8W 930 PS DIM IP20 WT	4058075799646	8	50/60 Hz	> 0.9	680	85	3000	90	36°
SP ADJ P 8W 940 PS DIM IP20 WT	4058075799660	8	50/60 Hz	> 0.9	720	90	4000	90	36°
SP ADJ P 8W 927 PS DIM IP20 BK	4099854000140	8	50/60 Hz	> 0.9	640	80	2700	90	36°
SP ADJ P 8W 930 PS DIM IP20 BK	4058075799684	8	50/60 Hz	> 0.9	680	85	3000	90	36°
SP ADJ P 8W 930 PS DIM IP20 SI	4058075799707	8	50/60 Hz	> 0.9	680	85	3000	90	36°

	EAN	 CC mA	 V _{DC}	IP	IK	Ø x h [mm]		 (°C)
SP FIX P 8W 927 PS DIM IP44 WT	4058075799523	180	30 - 40	44/20	05	81x42	0.3 kg	-20...+40
SP FIX P 8W 930 PS DIM IP44 WT	4058075799547	180	30 - 40	44/20	05	81x42	0.3 kg	-20...+40
SP FIX P 8W 940 PS DIM IP44 WT	4058075799561	180	30 - 40	44/20	05	81x42	0.3 kg	-20...+40
SP FIX P 8W 927 PS DIM IP44 BK	4099854000126	180	30 - 40	44/20	05	81x42	0.3 kg	-20...+40
SP FIX P 8W 930 PS DIM IP44 BK	4058075799585	180	30 - 40	44/20	05	81x42	0.3 kg	-20...+40
SP FIX P 8W 930 PS DIM IP44 SI	4058075799608	180	30 - 40	44/20	05	81x42	0.3 kg	-20...+40
SP ADJ P 8W 927 PS DIM IP20 WT	4058075799622	180	30 - 40	20	03	81x43	0.3 kg	-20...+40
SP ADJ P 8W 930 PS DIM IP20 WT	4058075799646	180	30 - 40	20	03	81x43	0.3 kg	-20...+40
SP ADJ P 8W 940 PS DIM IP20 WT	4058075799660	180	30 - 40	20	03	81x43	0.3 kg	-20...+40
SP ADJ P 8W 927 PS DIM IP20 BK	4099854000140	180	30 - 40	20	03	81x43	0.3 kg	-20...+40
SP ADJ P 8W 930 PS DIM IP20 BK	4058075799684	180	30 - 40	20	03	81x43	0.3 kg	-20...+40
SP ADJ P 8W 930 PS DIM IP20 SI	4058075799707	180	30 - 40	20	03	81x43	0.3 kg	-20...+40

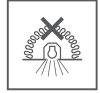
SPOT FIX



IP20

IP44

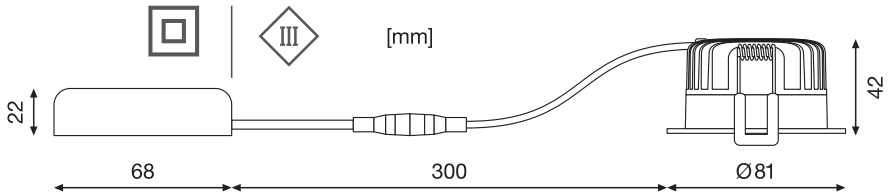
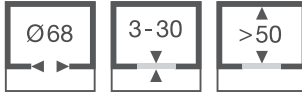

SPOT ADJUST

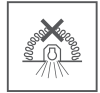

IP20

IP20

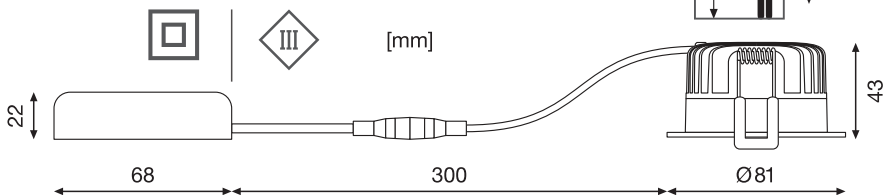
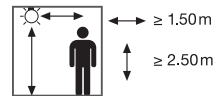

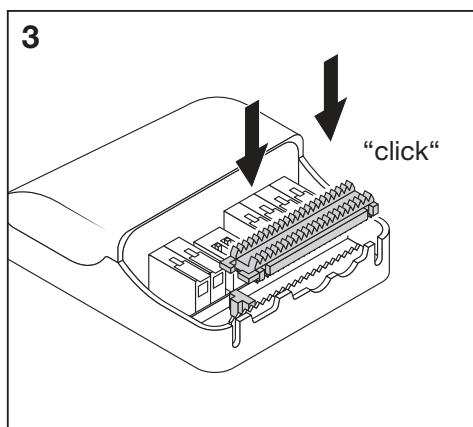
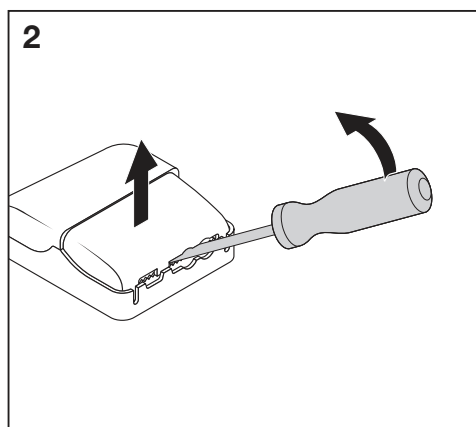
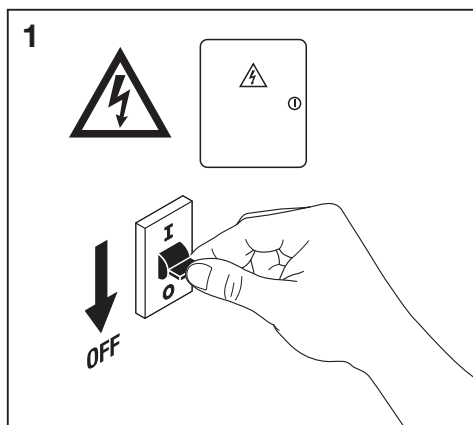
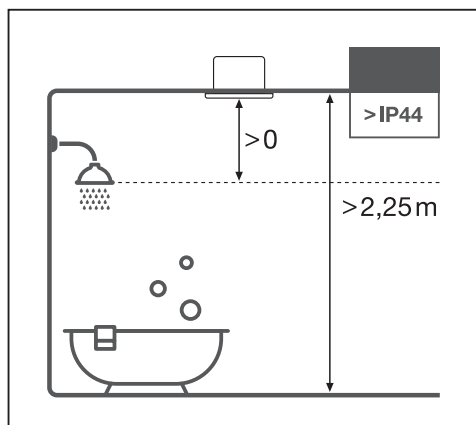
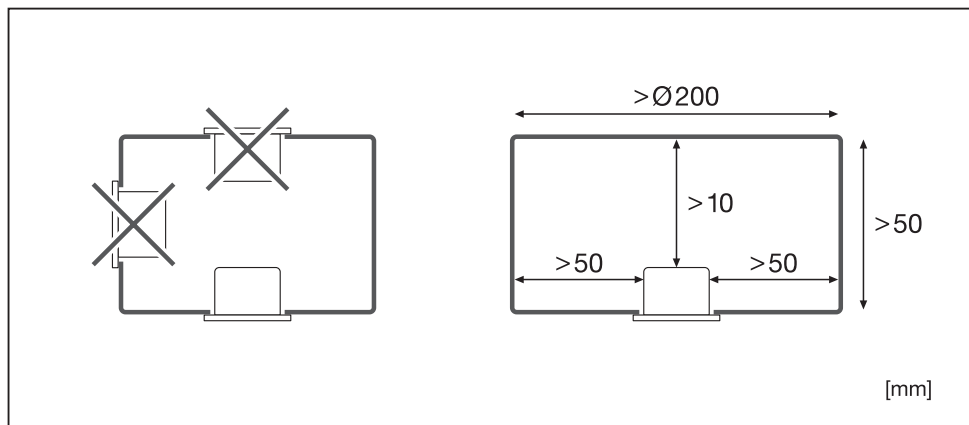

4

- 1 N Blue H03 VV-F 2x0.75 D5.5
- 2 PRI L Brown H03 VV-F 2x1.0 D6.0
- H03 VV-F 2x1.5 D7.5

- 3 SEC LED + Brown H03 VV H2-F 2x0.5
- Blue

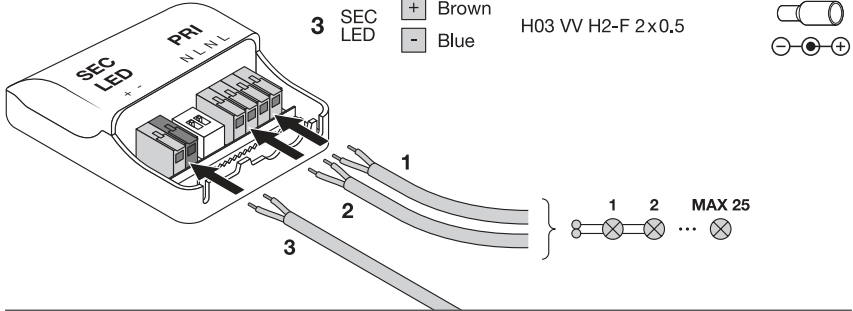

H03 VV-F 2 x 0.75 D 5.5
H05 VV-F 2 x 1.0 D 6.0

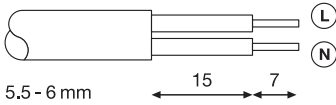

H05 VV-F 2 x 1.5 D 7.5

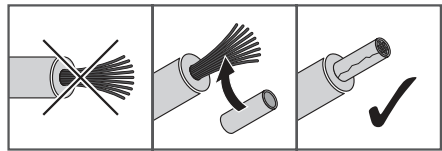
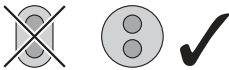
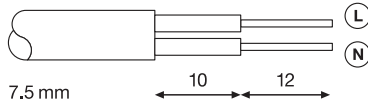

	C10	B16	C16
Spot Fix P 8 W	n=210	n=336	n=336
Spot Adjust P 8 W			

5

SPOT FIX
 SPOT ADJUST

	<input checked="" type="checkbox"/>	<input checked="" type="checkbox"/>	<input checked="" type="checkbox"/>	<input type="checkbox"/>
	Preset			
Current (CC)	85mA	140mA	180mA	85mA
Power	4W	6W	8W	4W
% rated lumen	50%	80%	100%	50%

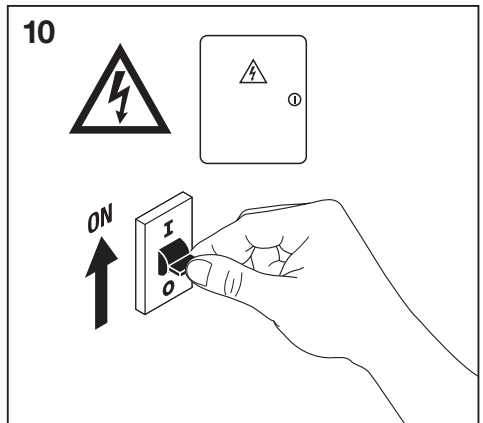
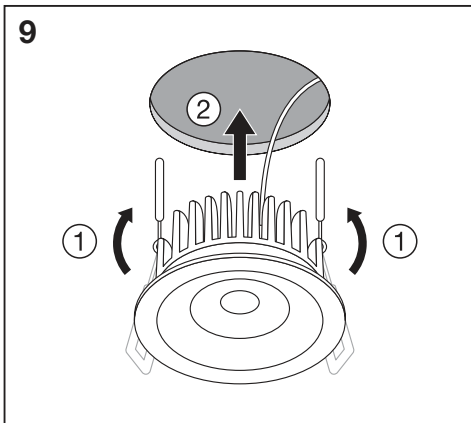
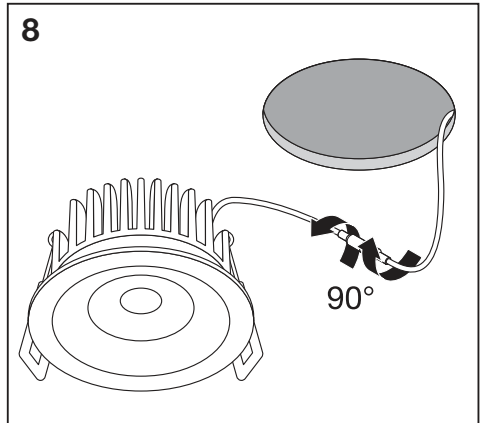
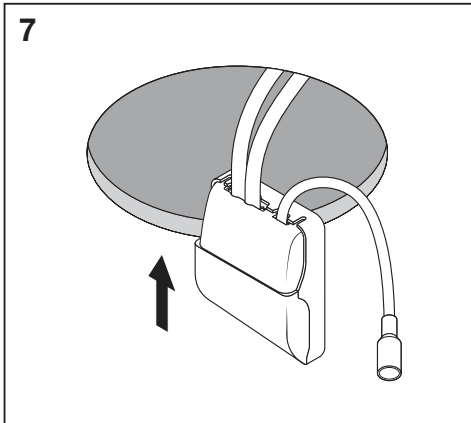
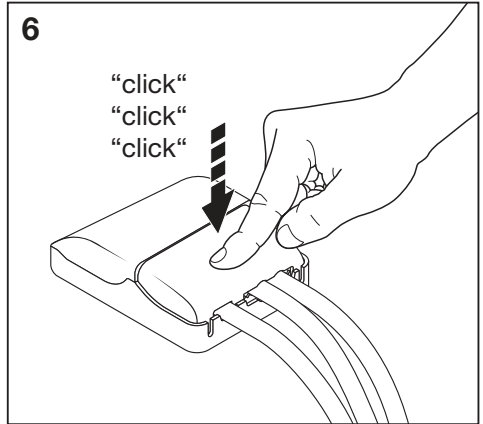

SP RING D133

EAN 4099854013355 (WHITE)

EAN 4099854013386 (BLACK)

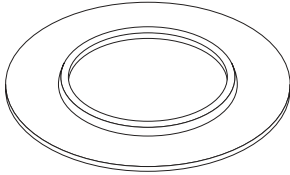

SP RING D180

EAN 4099854013416 (WHITE)

EAN 4099854013447 (BLACK)

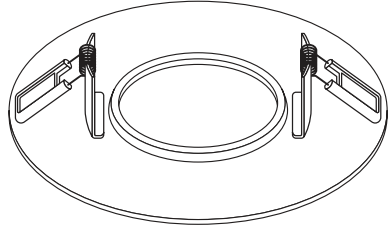

CONNECTOR BOX 3 POLE

EAN 4099854013508

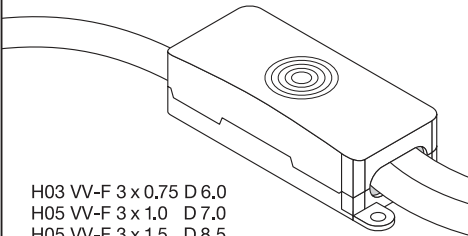

H03 VV-F 3 x 0,75 D 6,0

H05 VV-F 3 x 1,0 D 7,0

H05 VV-F 3 x 1,5 D 8,5

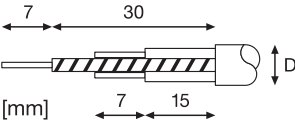

**SP DRIVER DALI
PLANNED**

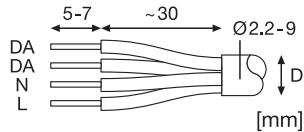
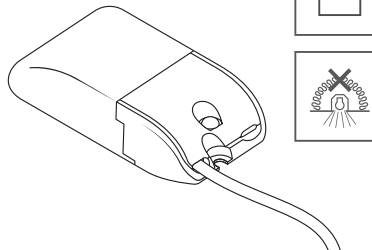

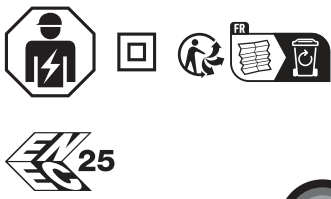
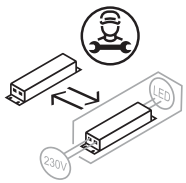

FR
Cet appareil et ses accessoires se recyclent
 À DÉPOSER EN MAGASIN
 À DÉPOSER EN DÉCHÈTERIE
 OU
 Points de collecte sur www.quefairedemesdechets.fr



LEDVANCE GmbH
 Steinerne Furt 62
 86167 Augsburg, Germany
www.ledvance.com

C10449058
 G11146529
 22.07.22

© LEDVANCE Ltd, Aquila House
 Delta Crescent, Westbrook, Warrington
 WA5 7NR, United Kingdom