

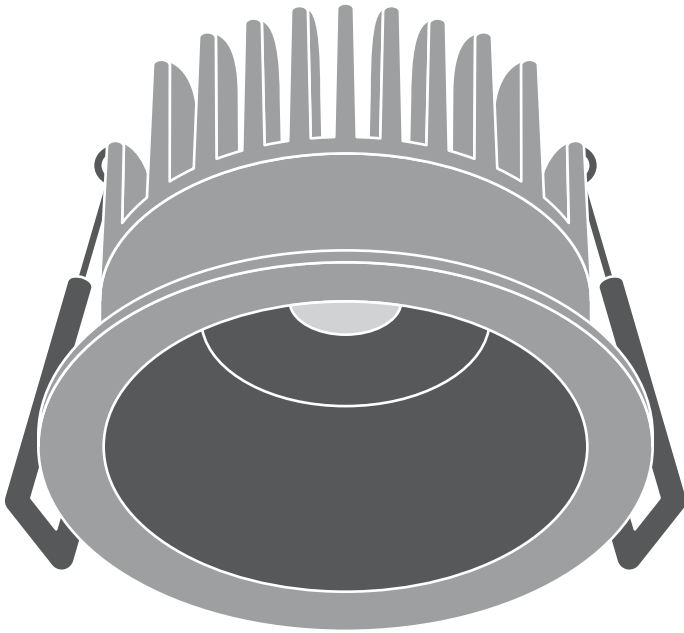





SPOT DARKLIGHT





	EAN	W	Hz	PF	lm	lm/W	K	R _a	
SP DK FIX P 8W 927 PS DIM IP44 WT	4058075799806	8	50/60 Hz	> 0.9	640	80	2700	90	36°
SP DK FIX P 8W 930 PS DIM IP44 WT	4058075799820	8	50/60 Hz	> 0.9	680	85	3000	90	36°
SP DK FIX P 8W 940 PS DIM IP44 WT	4058075799844	8	50/60 Hz	> 0.9	720	90	4000	90	36°
SP DK FIX P 8W 927 PS DIM IP44 BK	4099854000164	8	50/60 Hz	> 0.9	640	80	2700	90	36°
SP DK FIX P 8W 930 PS DIM IP44 BK	4058075799868	8	50/60 Hz	> 0.9	680	85	3000	90	36°
SP DK FIX P 8W 930 PS DIM IP44 SI	4058075799882	8	50/60 Hz	> 0.9	680	85	3000	90	36°

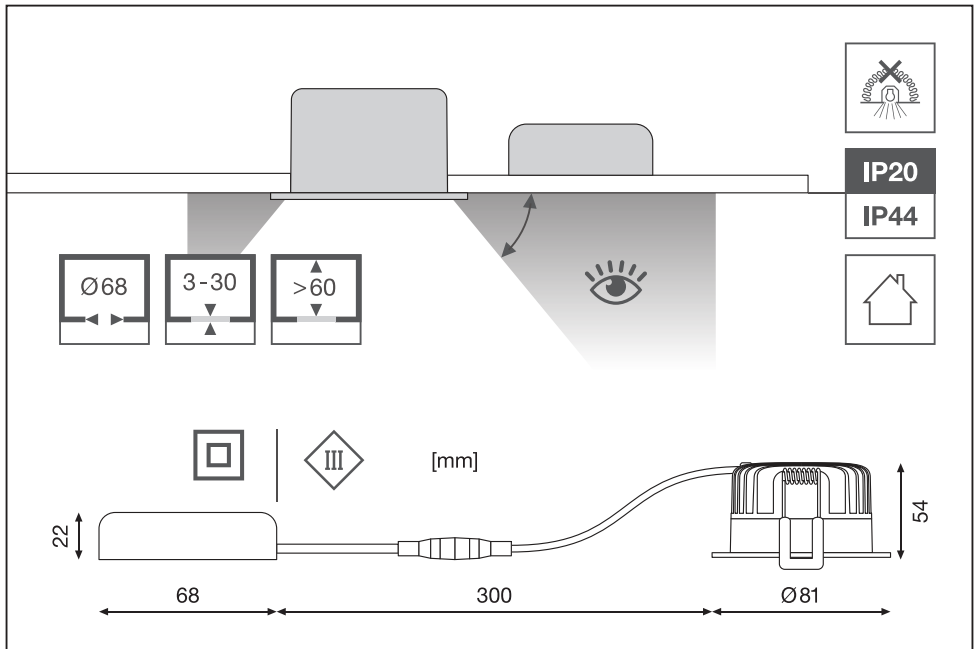
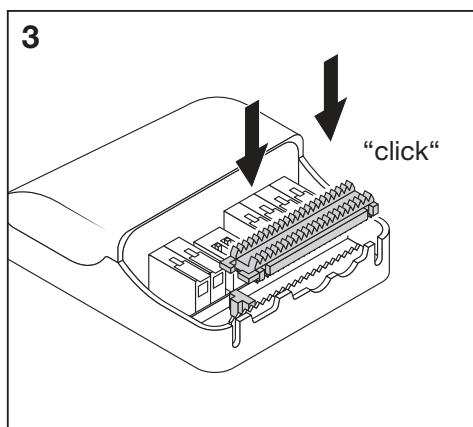
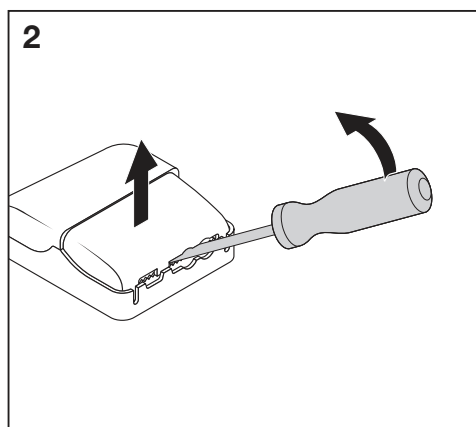
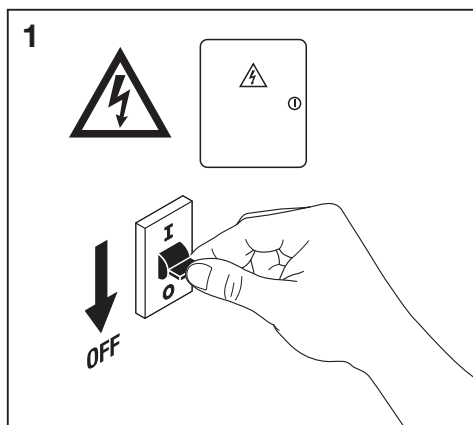
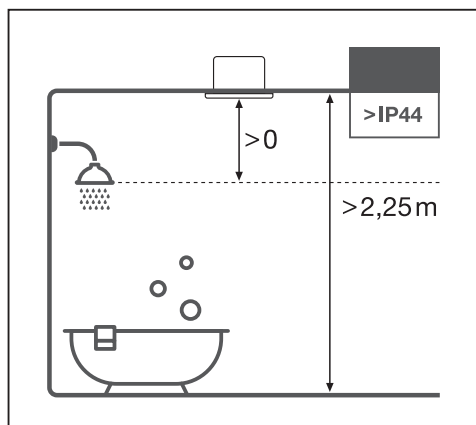
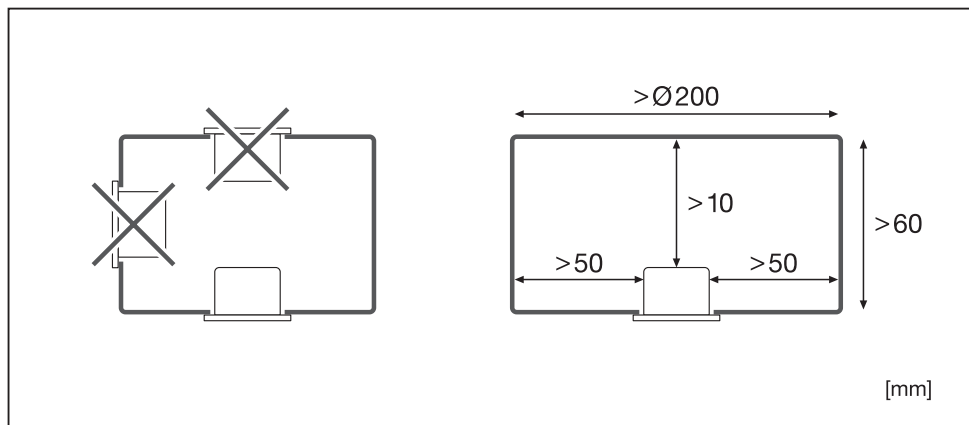

	EAN	 CC mA	 V _{dc}	IP	IK	Ø x h [mm]		 (°C)
SP DK FIX P 8W 927 PS DIM IP44 WT	4058075799806	180	30 - 40	44/20	03	81x54	0.3 kg	-20...+40
SP DK FIX P 8W 930 PS DIM IP44 WT	4058075799820	180	30 - 40	44/20	03	81x54	0.3 kg	-20...+40
SP DK FIX P 8W 940 PS DIM IP44 WT	4058075799844	180	30 - 40	44/20	03	81x54	0.3 kg	-20...+40
SP DK FIX P 8W 927 PS DIM IP44 BK	4099854000164	180	30 - 40	44/20	03	81x54	0.3 kg	-20...+40
SP DK FIX P 8W 930 PS DIM IP44 BK	4058075799868	180	30 - 40	44/20	03	81x54	0.3 kg	-20...+40
SP DK FIX P 8W 930 PS DIM IP44 SI	4058075799882	180	30 - 40	44/20	03	81x54	0.3 kg	-20...+40





4

- 1 N Blue H03 VV-F 2x0.75 D5.5 
- 2 PRI L Brown H03 VV-F 2x1.0 D6.0 
- H03 VV-F 2x1.5 D7.5 

- 3 SEC LED + Brown H03 VV H2-F 2x0.5 
- Blue 

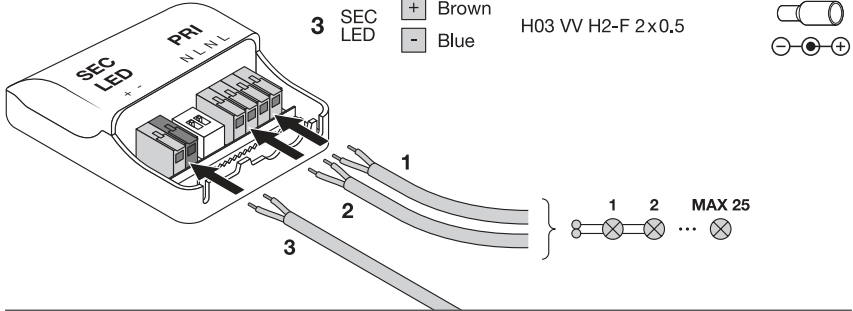

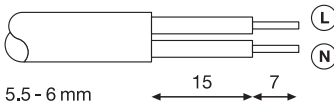

H03 VV-F 2 x 0.75 D 5.5
H05 VV-F 2 x 1.0 D 6.0

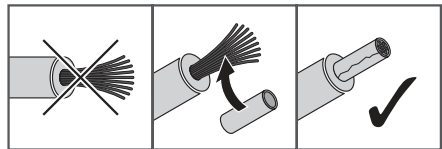
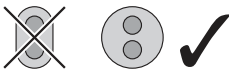
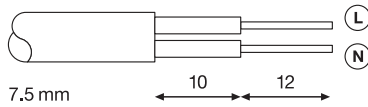

H05 VV-F 2 x 1.5 D 7.5



C10	B16	C16
		
n=336	n=336	n=210

5

	✓	✓	✓	○
	ON	ON	ON	ON
	1 2	1 2	1 2	1 2
Current (CC)	85mA	140mA	180mA	85mA
Power	4W	6W	8W	4W
% rated lumen	50%	80%	100%	50%

Preset

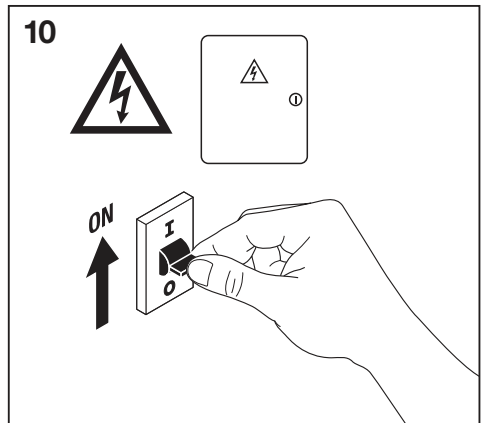
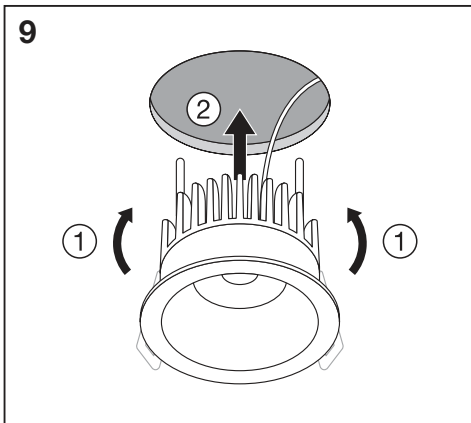
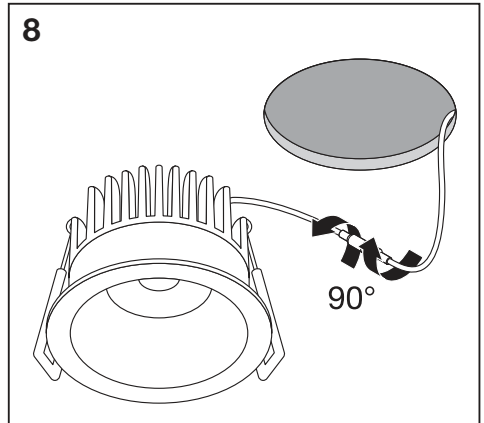
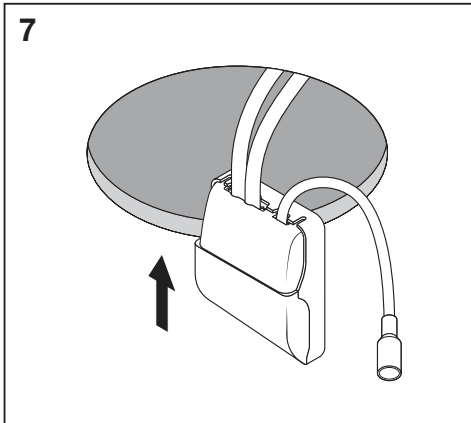
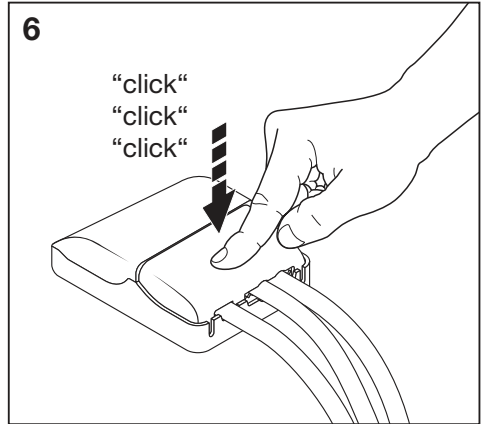

SP RING D133

EAN 4099854013355 (WHITE)

EAN 4099854013386 (BLACK)

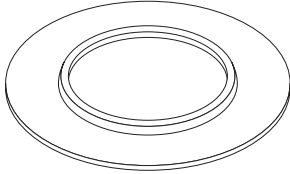

SP RING D180

EAN 4099854013416 (WHITE)

EAN 4099854013447 (BLACK)

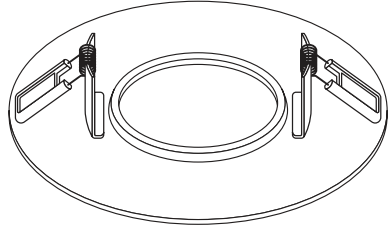

CONNECTOR BOX 3 POLE

EAN 4099854013508

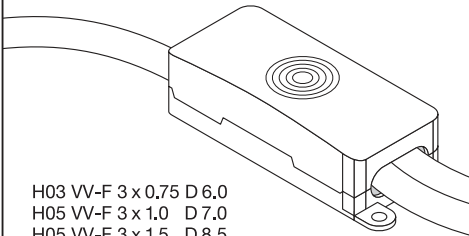

H03 VV-F 3 x 0,75 D 6,0

H05 VV-F 3 x 1,0 D 7,0

H05 VV-F 3 x 1,5 D 8,5

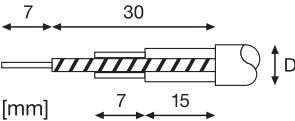

**SP DRIVER DALI
PLANNED**

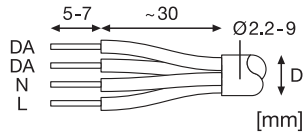
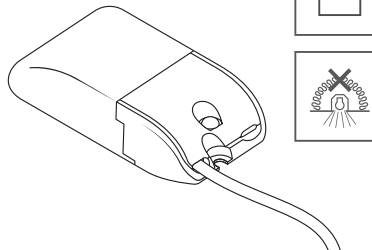
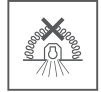

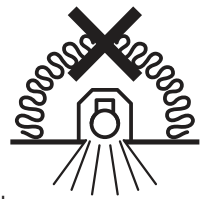
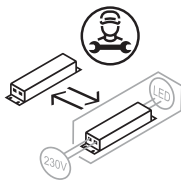

FR
Cet appareil et ses accessoires se recyclent

À DÉPOSER EN MAGASIN
OU
À DÉPOSER EN DÉCHÈTERIE



Points de collecte sur www.quefairedemesdechets.fr



LEDVANCE GmbH
Steinerne Furt 62
86167 Augsburg, Germany
www.ledvance.com

C10449058
G11146531
22.07.22

© LEDVANCE Ltd, Aquila House
Delta Crescent, Westbrook, Warrington
WA5 7NR, United Kingdom