

# PRODUCT DATASHEET

## PL CMFT 600 P 33W 840 DALIVR

PANEL COMFORT 600 DALI | Square recessed panel luminaire, for 600 x 600 mm ceiling systems and DALI-2 IoT technology

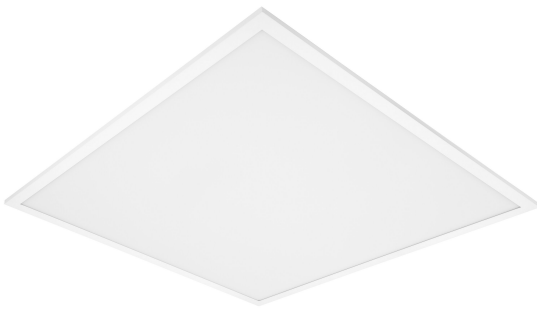

### Areas of application

- Direct replacement for recessed luminaires with fluorescent lamps
- Offices, conference rooms
- Reception areas, foyers, corridors, elevators
- Suitable for recessed ceiling systems with grid size of 600 x 600 mm

### Product benefits

- Suitable luminaire for VIVARES and other DALI-2 Light Management Systems
- Tool-free electrical connection due to push button connector
- Through-wiring possible with included connector box
- Energy savings thanks to high system efficacy: up to 130 lm/W
- High color consistency with SDCM 3
- Extended services such as energy monitoring and remote maintenance possible with DALI versions
- External driver for extended flexibility and easy installation
- Low flicker light thanks to special electronic control gear
- Suitable for emergency lighting
- 5 years guarantee

### Product features

- IoT-ready luminaire with DALI-2 technology
- Suitable for central battery emergency installations acc. to EN 60598-2-22



- Push DIM function for dimming and switching directly on a pushbutton
- Extruded aluminum frame
- Polystyrene diffuser
- 5-pole terminal block, cable cross section up to 5 x 2.5 mm<sup>2</sup>
- Lifetime (L80/B10): 70,000 h (at 25 °C)



## TECHNICAL DATA

### Electrical data

|  |                       |
|--|-----------------------|
| Nominal wattage                          | 33.00 W <sup>1)</sup> |
| Nominal voltage                          | 220...240 V           |
| Mains frequency                          | 0/50/60 Hz            |
| Nominal current                          | 150.000 mA            |
| Inrush current                           | 4.4 A                 |
| Inrush current time T <sub>h50</sub>     | 440 µs                |
| Max. no. of lum. on circuit break. B16 A | 40                    |
| Max. no. of lum. on circuit break. C10 A | 40                    |
| Max. no. of lum. on circuit break. C16 A | 65                    |
| Power factor λ                           | > 0.90                |
| Total harmonic distortion                | < 20 %                |
| Protection class                         | II                    |
| Operating mode                           | External LED driver   |

<sup>1)</sup> CR180 versions of the Panel Comfort family are fulfilling the technical minimum requirements according to the German BEG subsidy program for energy efficient luminaires

### Photometrical data

|  |                        |
|--|------------------------|
| Luminous flux                                | 4320 lm <sup>1)</sup>  |
| Luminous efficacy                            | 130 lm/W <sup>1)</sup> |
| Color temperature                            | 4000 K                 |
| Light color (designation)                    | Cool White             |
| Color rendering index Ra                     | > 80                   |
| Standard deviation of color matching         | ≤3 sdc <sub>m</sub>    |
| Low flicker                                  | Yes                    |
| Flickering metric (Pst LM)                   | <1                     |
| Stroboscope effect metric (SVM)              | < 0.4                  |
| Photobiological safety group acc. to EN62778 | RG0                    |
| Beam angle                                   | 110 °                  |

<sup>1)</sup> CR180 versions of the Panel Comfort family are fulfilling the technical minimum requirements according to the German BEG subsidy program for energy efficient luminaires



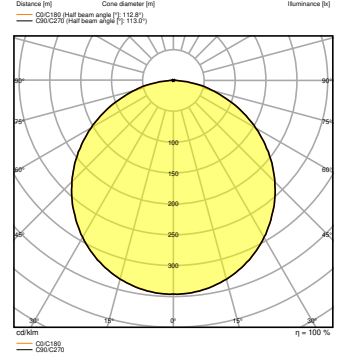
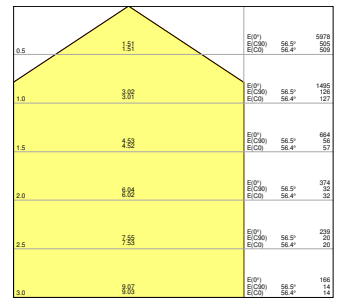
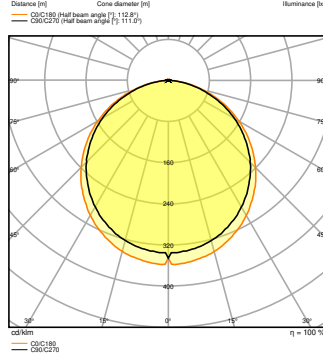
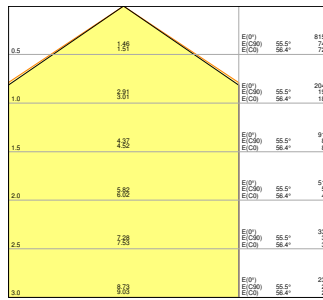
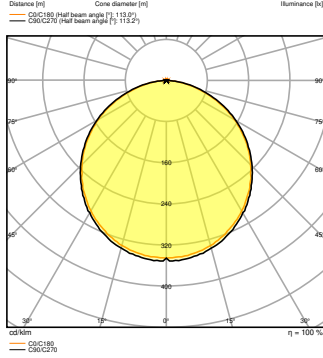
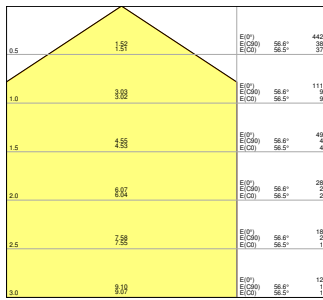

## Dimensions & Weight

|                |           |
|----------------|-----------|
| Length         | 595.00 mm |
| Width          | 595.00 mm |
| Height         | 32.00 mm  |
| Product weight | 1770.00 g |

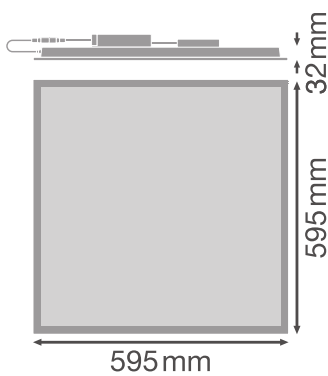

## Materials & Colors

|               |       |
|---------------|-------|
| Product color | White |
|---------------|-------|



|  |                  |
|--|------------------|
| Housing color                              | White            |
| Body material                              | Aluminum         |
| Cover material                             | Polystyrene (PS) |
| Light emitting surface material            | Polystyrene      |
| Glow Wire Test according to IEC 60695-2-12 | 650 °C           |
| Mercury content                            | 0.0 mg           |

### Application & Mounting

|  |   |
|--|---|
| Ambient temperature range              | -10...+50 °C                                    |
| Temperature range at storage           | -20...+80 °C                                    |
| Type of connection                     | Screwless terminal, 5-Pole (L, N, PE, DA+, DA-) |
| Type of protection                     | IP40/IP20                                       |
| Protection class IK (shock resistance) | IK02  |
| Dimmable                               | Yes   |
| Type of dimming                        | DALI2   |
| Mounting type                          | Recessed/Suspended/Surface                      |
| Mounting location                      | Ceiling   |
| Application environment                | Indoor  |
| Mounting length                        | 575 mm  |
| Mounting width                         | 575 mm  |
| Mounting depth                         | 50,0 mm   |
| Adjustable                             | No  |
| LED module replaceable                 | Not replaceable                                 |
| With light source                      | Yes   |

### Lifespan

|                            |          |
|----------------------------|----------|
| Lifespan L70/B50 at 25 °C  | 100000 h |
| Lifespan L80/B10 at 25 °C  | 70000 h  |
| Lifespan L90/B10 at 25 °C  | 48000 h  |
| Number of switching cycles | 50000    |

### Control gear

|                             |           |
|-----------------------------|-----------|
| Output current              | 730 mA    |
| ECG - Output ripple current | < 5 %     |
| ECG - Length                | 209,00 mm |
| ECG - Width                 | 42.5 mm   |
| ECG - Height                | 30 mm     |



|                          |   |
|--------------------------|---|
| Recommended control gear | OSRAM OTI DALI 50/220-240/1A4 NFC; Tridonic LCA 45W 500-1400mA one4all SC PRE |
|--------------------------|---|

### Certificates & Standards

|  |                             |
|--|-----------------------------|
| Standards  | CE / CB / ENEC / UKCA / EAC |
| Luminaire with limited surface temperature, "D sign" | No                          |
| Ball shot safe                                       | No                          |









### Additional product data

|                |                              |
|----------------|------------------------------|
| Product remark | Available from December 2022 |
|----------------|------------------------------|

### EQUIPMENT / ACCESSORIES

- Accessories for several mounting options available
- Connector box with 5-pole terminal included
- Security rope for luminaire included
- Security brackets preinstalled
- External control gear included
- Suitable for use with separate Emergency Conversion Box

### DOWNLOAD DATA

| DOWNLOAD DATA   |                             |
|---|-----------------------------|
|   | User instruction            |
|   | Addon Technical Information |
|  | IES file (IES)              |
|  | IES file (IES)              |
|  | IES file (IES)              |
|  | LDT file (Eulumdat)         |
|  | LDT file (Eulumdat)         |
|  | LDT file (Eulumdat)         |



## DOWNLOAD DATA



R3D file (Relux 3D Model)



M3D file (3D Model)



UGR file (UGR table)



UGR file (UGR table)



UGR file (UGR table)



Packaging insert

## LOGISTICAL DATA

| Product code  | Packaging unit (Pieces/Unit) | Dimensions (length x width x height) | Gross weight | Volume                 |
|---------------|------------------------------|--------------------------------------|--------------|------------------------|
| 4099854015359 | Shipping box<br>4            | 647 mm x 222 mm x 724 mm             | 10768.00 g   | 103.99 dm <sup>3</sup> |

The mentioned product code describes the smallest quantity unit which can be ordered. One shipping unit can contain one or more single products. When placing an order, for the quantity please enter single or multiples of a shipping unit.

## ADDITIONAL CATALOG INFORMATION

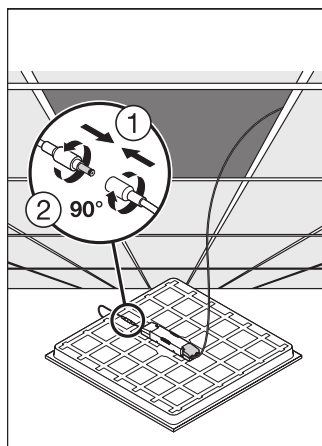
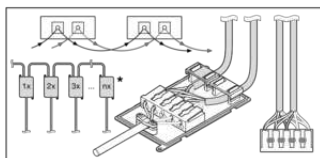

## References / Links

- For Guarantee see [www.ledvance.com/guarantee](http://www.ledvance.com/guarantee)



## DISCLAIMER

Subject to change without notice. Errors and omission excepted. Always make sure to use the most recent release.

