

PRODUCT DATASHEET

PL COMP 600 V 33W 830 DALI

PANEL COMPACT 600 DALI | Square recessed panel luminaire, for 600 x 600 mm ceiling systems and DALI-2 technology

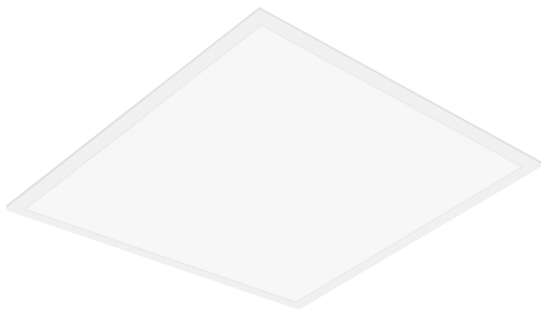

Areas of application

- Direct replacement for luminaires with fluorescent lamps
- Offices, conference rooms
- Reception areas, foyers, corridors, elevators
- Suitable for recessed ceiling systems with grid size of 600 x 600 mm

Product benefits

- Low flicker light thanks to special electronic control gear
- External driver for extended flexibility and easy installation
- Suitable for emergency lighting
- 5 years guarantee

Product features

- Suitable for central battery emergency installations acc. to EN 60598-2-22
- Push DIM function for dimming and switching directly on a pushbutton
- Extruded aluminum frame
- Polystyrene diffuser
- Lifetime (L80/B10): up to 50,000 h (at 25 °C)



TECHNICAL DATA

Electrical data

Nominal wattage	33.00 W
Nominal voltage	220...240 V
Mains frequency	0/50/60 Hz
Nominal current	190.000 mA
Inrush current	1.7 A
Inrush current time T_{h50}	52 μ s
Max. no. of lum. on circuit break. B16 A	83
Max. no. of lum. on circuit break. C10 A	52
Max. no. of lum. on circuit break. C16 A	83
Power factor λ	> 0.90
Total harmonic distortion	< 10 %
Protection class	II
Operating mode	External LED driver

Photometrical data

Luminous flux	3630 lm
Luminous efficacy	110 lm/W
Color temperature	3000 K
Light color (designation)	Warm White
Color rendering index Ra	> 80
Standard deviation of color matching	≤ 5 sdc _m
Low flicker	Yes
Flickering metric (Pst LM)	<1
Stroboscope effect metric (SVM)	< 0.4
Photobiological safety group acc. to EN62778	RG0
Beam angle	120 °



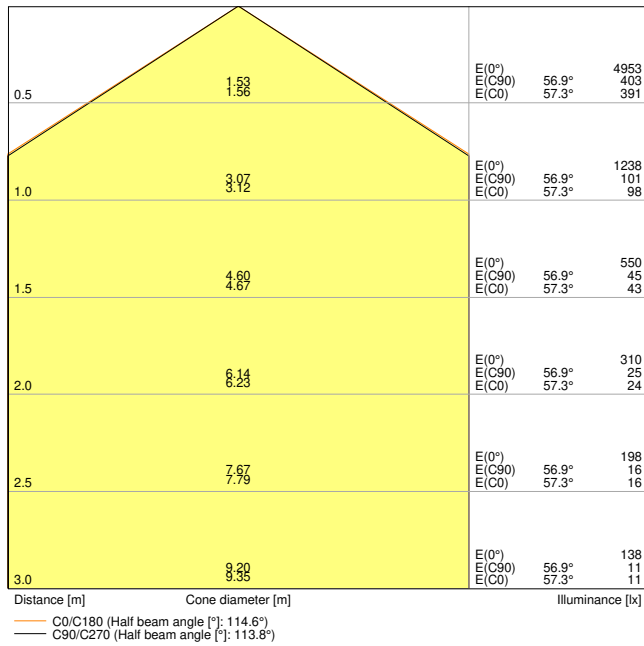

LDC typ cone

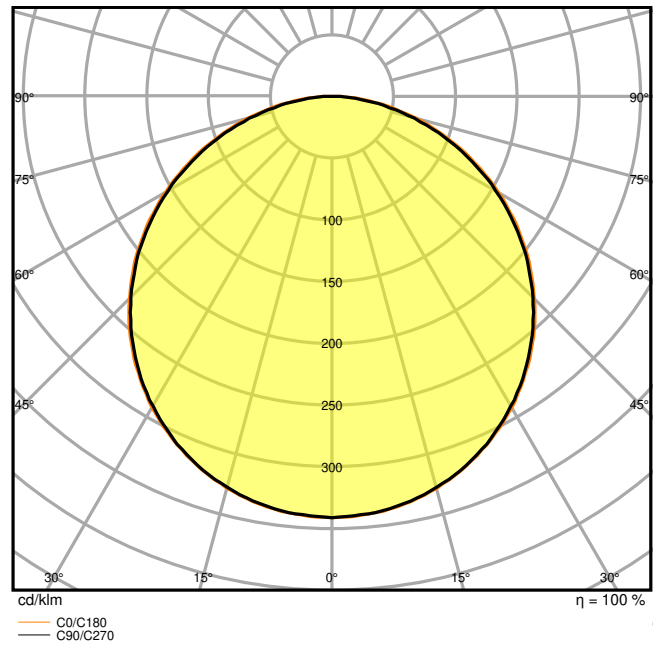

LDC typ polar

Dimensions & Weight

Length	595.00 mm
Width	595.00 mm
Height	32.00 mm
Product weight	1543.00 g

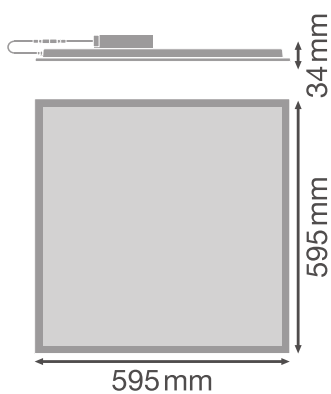

Materials & Colors

Product color	White
Housing color	White
Body material	Aluminum
Cover material	Polystyrene (PS)
Light emitting surface material	Polystyrene
Glow Wire Test according to IEC 60695-2-12	650 °C
Mercury content	0.0 mg

Application & Mounting

Ambient temperature range	-10...+45 °C
Temperature range at storage	-20...+70 °C
Type of connection	Screwless terminal, 4-Pole (L,N, DA+, DA-)
Type of protection	IP40/IP20
Protection class IK (shock resistance)	IK02
Dimmable	Yes
Type of dimming	DALI2
Mounting type	Recessed/Suspended/Surface
Mounting location	Ceiling
Application environment	Indoor
Mounting length	575 mm
Mounting width	575 mm
Mounting depth	50,0 mm
Adjustable	No
LED module replaceable	Not replaceable
With light source	Yes

Lifespan

Lifespan L70/B50 at 25 °C	70000 h
Lifespan L80/B10 at 25 °C	50000 h
Lifespan L90/B10 at 25 °C	40000 h
Number of switching cycles	50000

Control gear

Output current	700 mA
ECG - Output ripple current	< 7 %
ECG - Length	168 mm



ECG - Width	44 mm
ECG - Height	32 mm
Recommended control gear	LEDV DR DALI-P-44/220-240/1050; Tridonic LCA 45W 500-1400mA one4all SC PRE

Certificates & Standards

Standards	CE / CB / TÜV / UKCA / EAC
Luminaire with limited surface temperature, "D sign"	No
Ball shot safe	No







Additional product data

Product remark	Available from December 2022
----------------	------------------------------

EQUIPMENT / ACCESSORIES

- Accessories for several mounting options available
- Security rope for luminaire included
- Security brackets preinstalled
- External control gear included
- Suitable for use with separate Emergency Conversion Box
- Connector box with 5-pole terminal for through-wiring separately available for cable cross sections up to 2.5 mm²

DOWNLOAD DATA

DOWNLOAD DATA	
	User instruction
	Addon Technical Information
	IES file (IES)
	LDT file (Eulumdat)
	R3D file (Relux 3D Model)
	M3D file (3D Model)
	UGR file (UGR table)



DOWNLOAD DATA



Packaging insert

LOGISTICAL DATA

Product code	Packaging unit (Pieces/Unit)	Dimensions (length x width x height)	Gross weight	Volume
4099854017803	Folding box 1	602 mm x 37 mm x 649 mm	1911.00 g	14.46 dm ³
4099854017810	Shipping box 4	664 mm x 164 mm x 628 mm	8554.00 g	68.39 dm ³

The mentioned product code describes the smallest quantity unit which can be ordered. One shipping unit can contain one or more single products. When placing an order, for the quantity please enter single or multiples of a shipping unit.

ADDITIONAL CATALOG INFORMATION

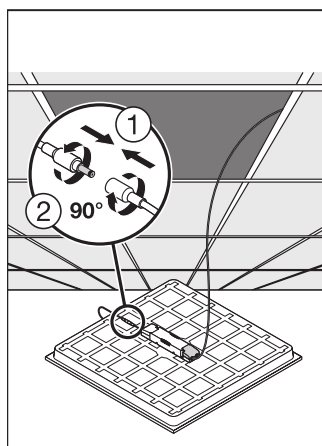
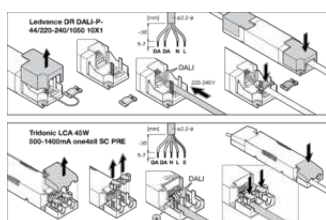

References / Links

- For Guarantee see www.ledvance.com/guarantee

DISCLAIMER

Subject to change without notice. Errors and omission excepted. Always make sure to use the most recent release.

