

 **Descripción/** Balance.

- Materiales/**
- Acero y polietileno de alta densidad de 2 cm de espesor.
 - Polietileno con goma antideslizante en asientos
 - Muelle antipinzamiento.

 **Description/** Seesaw.

- Materials/**
- Steel and 2cm thick HDPE.
 - Anti-slippery rubber covered HDPE seats.
 - Spring with anti-pinch design.

 **Description/** Balançoire à bascule sur ressort.

- Matériaux/**
- Structure en acier et polyéthylène haute densité 2 cm d'épaisseur.
 - Sièges en polyéthylène haute densité avec un revêtement antidérapant.
 - Ressort avec système anti-pincement.

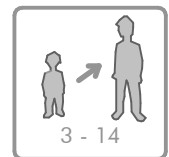
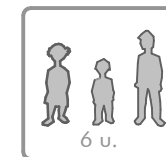
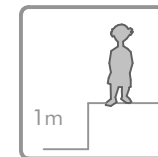
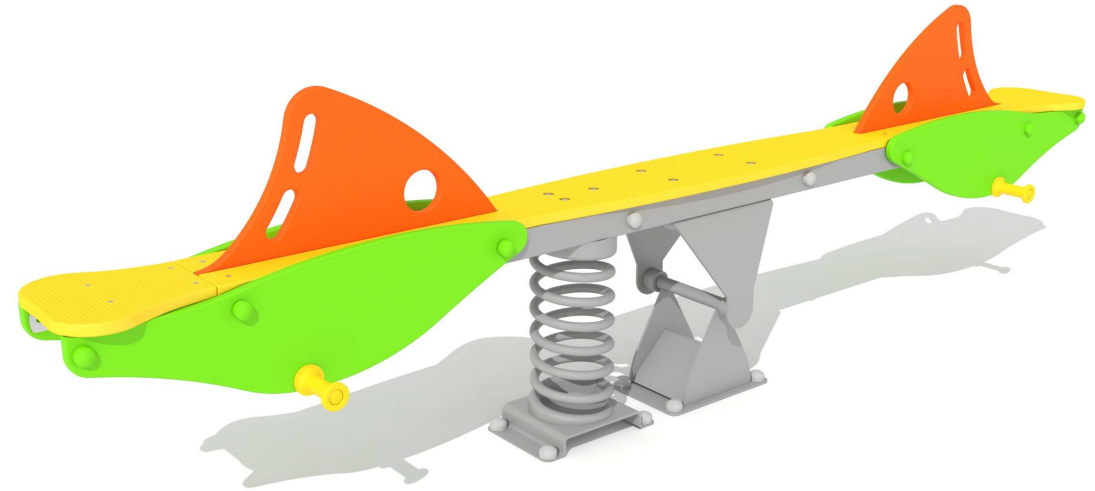

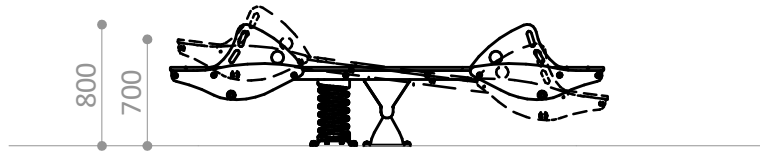

ESPACIO DE SEGURIDAD / ALTURA DE CAIDA LIBRE
SAFETY AREA / FREE HEIGHT OF FALL
ZONE DE SECURITÉ / HAUTEUR DE CHUTE LIBRE

11,2 m² / 1 m

Superficie según EN-1176-1
Surface according to EN-1176-1
Revêtement conformément à la Norme EN-1176-1

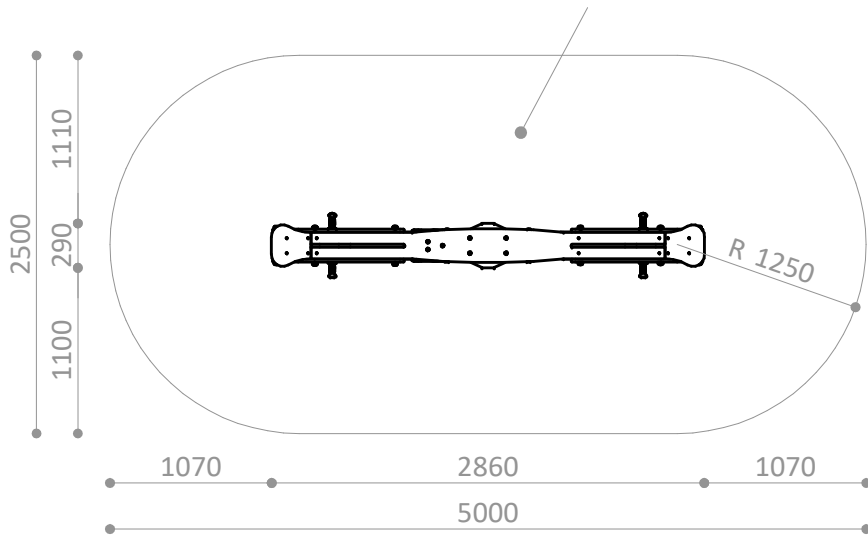

R4010

Pieza más grande

Biggest part

La plus grande pièce

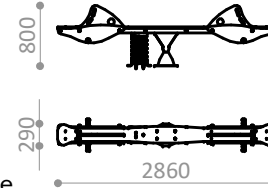

R4010

Pieza más pesada

Heaviest part

La pièce la plus lourde

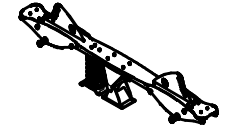

84 Kg.

R4010A

Suelo de hormigón

Concrete ground

Fixation sur béton

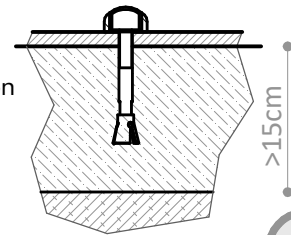

x8

R4010E

Otros suelos

Other grounds

Autres sols

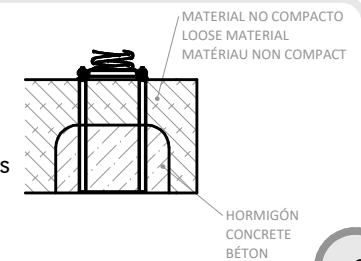

x2

Disponibilidad de repuestos durante 10 años.
Spare parts available for 10 years.
Disponibilité de pièces de rechange pendant 10 ans.

Industrias Agapito se reserva el derecho a modificar sin previo aviso los elementos descritos en este documento.
Industrias Agapito reserves the right to change the items described in this document without prior notice.
Industrias Agapito se réserve le droit de modifier à tout moment et sans préavis les éléments décrits dans le présent document.



R4010

LOS TIBURONCINES
THE LITTLE SHARKS SEESAW
LES PETITS REQUINS

FICHA TECNICA
TECHNICAL SHEET
FICHE TECHNIQUE
FT-R4010rev04 - 3/3

