

 **Descripción** Columpio de 2 plazas con asientos de seguridad para bebés. Disponible R4150, con asientos planos y R4150M, mixto, con 1 asiento plano y 1 asiento de seguridad para bebés.

- Materiales**
- Acero galvanizado con poliéster termoendurecido.
  - Polietileno de alta densidad, libre de mantenimiento y antigraffiti.
  - Asientos de seguridad para bebés y cadenas de acero inoxidable

 **Description** Swing with 2 cradle seats for babies. Other models R4150M with 1 flat seat and 1 safety cradle seat for babies and R4150 with 2 flat seats.

- Materials**
- Thermohardened polyester painted galvanized steel structure.
  - Anti-graffiti, maintenance free HDPE.
  - Safety cradle seats for babies and stainless steel chains.

 **Description** Portique avec 2 siège de sécurité pour bébés. Aussi disponible: R4150M, avec 1 siège plan et 1 siège de sécurité pour bébés et R4150 avec 2 sièges plans.

- Matériaux**
- Structure en acier galvanisé avec peinture polyester thermodurcie.
  - Polyéthylène haute densité, libre d'entretien et antigraffiti.
  - Sièges de sécurité pour bébés et chaînes en acier inoxydable.

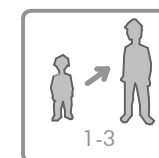
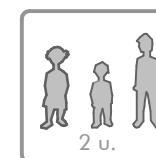
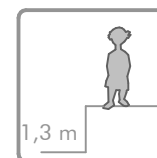

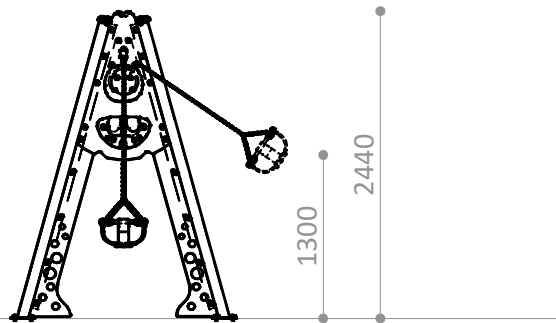

### POSTE R4150 - 01

Pieza mas grande  
 Biggest part  
 La plus grande pièce

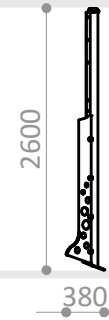

### POSTE R4150 - 01

Pieza mas pesada  
 Heaviest part  
 La pièce la plus lourde



R4150CA  
 ÁREA LIBRE DE OBSTÁCULOS  
 FREE SPACE  
 ZONE LIBRE D' OBSTACLES

ESPACIO DE SEGURIDAD / ALTURA DE CAIDA LIBRE  
 SAFETY AREA / FREE HEIGHT OF FALL  
 ZONE DE SECURITÉ / HAUTEUR DE CHUTE LIBRE

20,5 m2 / 1,3 m

R4150CE  
 ESPACIO DE SEGURIDAD  
 SAFETY AREA  
 ZONE DE SECURITÉ

Superficie según EN-1176-1  
 Surface according to EN-1176-1  
 Revêtement conformément à la Norme EN-1176-1

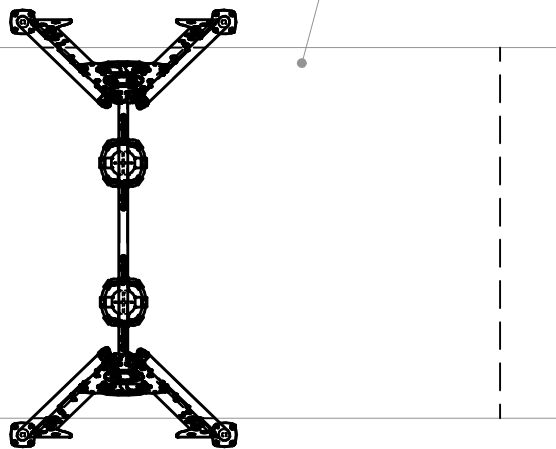

1790  
 5980  
 6980

### R4150CA

Suelo de hormigón  
 Concrete ground  
 Fixation sur béton

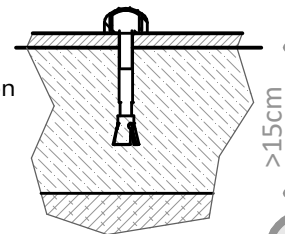

x16

### R4150CE

MATERIAL NO COMPACTO  
 LOOSE MATERIAL  
 MATÉRIAU NON COMPACT  
 Otros suelos  
 Other grounds  
 Autres sols

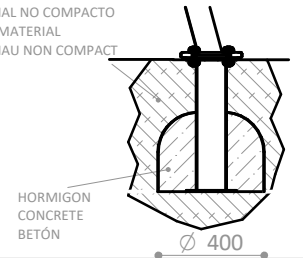

x4

Disponibilidad de repuestos durante 10 años.  
 Spare parts available for 10 years.  
 Disponibilité de pièces de rechange pendant 10 ans.

Industrias Agapito se reserva el derecho a modificar sin previo aviso los elementos descritos en este documento.  
 Industrias Agapito reserves the right to change the items described in this document without prior notice.  
 Industrias Agapito se réserve le droit de modifier à tout moment et sans préavis les éléments décrits dans le présent document.



