



ESPACIO DE SEGURIDAD / ALTURA DE CAIDA LIBRE
SAFETY AREA / FREE HEIGHT OF FALL
ZONE DE SECURITÉ / HAUTEUR DE CHUTE LIBRE

- A - 31m² / 3m
- B - 30m² / 1,49m
- C - 22m² / 1m

$$A + B + C = 83m^2$$

Superficie según EN-1176-1
Surface according to EN-1176-1
Revêtement conformément à la Norme EN-1176-1

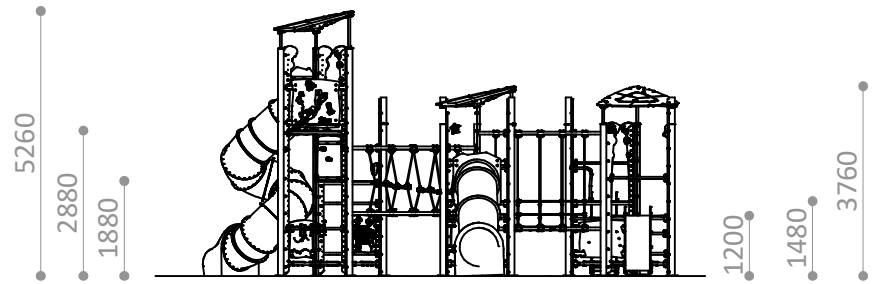

Disponibilidad de repuestos durante 10 años.
Spare parts available for 10 years.
Disponibilité de pièces de rechange pendant 10 ans.

Industrias Agapito se reserva el derecho a modificar sin previo aviso los elementos descritos en este documento.
Industrias Agapito reserves the right to change the items described in this document without prior notice.
Industrias Agapito se réserve le droit de modifier à tout moment et sans préavis les éléments décrits dans le présent document.

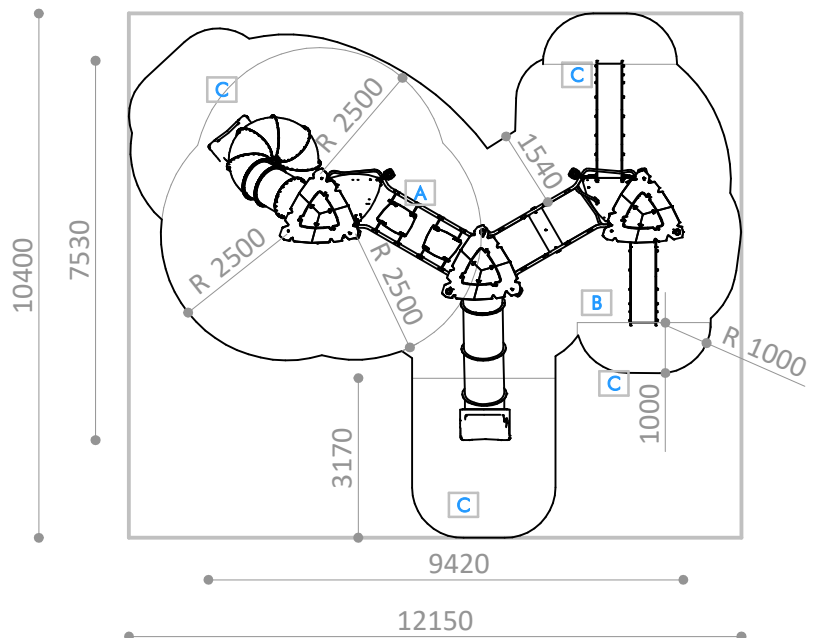

R4268XA

Suelo de hormigón
Concrete ground
Fixation sur béton

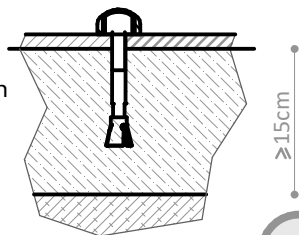

x44

R4268XE

Otros suelos
Other grounds
Autres sols

MATERIAL NO COMPACTO
LOOSE MATERIAL
MATÉRIAU NON COMPACT

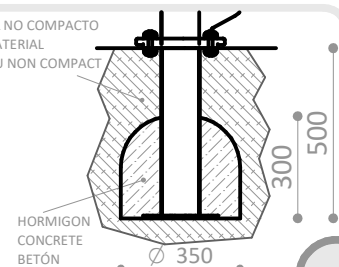

HORMIGÓN
CONCRETE
BETÓN

x11

PIEZA MÁS GRANDE
BIGGEST PART
LA PLUS GRANDE PIECE
4560 x 480 x 430 mm

PIEZA MÁS PESADA
HEAVIEST PART
LA PIECE LA PLUS LOURDE
83 Kg

**Descripción/**

Multijuego gigante de dimensiones 9,41m x 7,33m x 5,26m altura total y área de juego 87m² con temática marina. Integra 4 toboganes (1 gruta helicoidal, gruta recto y 2 abiertos rectos) y 14 juegos infantiles distribuidos en 2 torres triangulares dobles y 1 triangular. Con decoración temática marina. Composición:

Torre doble con cubierta (HTOTAL / PLATAFORMAS = 5,26m / 2,88m y 1,88m):

- Barrera interactiva de peces deslizantes.
- Panel Sopa de letras.
- Photocall submarinista.
- Acceso exterior escalera de barras.
- Asientos dobles de tertulia.
- Barra de psicomotricidad.
- Acceso rocódromo.
- Tobogán gruta helicoidal con giro de 360° en polietileno de alta densidad. H = 3m.

Torre central con cubierta (HTOTAL / PLATAFORMA = 3,76m / 1,48m):

- Tobogán gruta recto de polietileno de alta densidad. H = 1,5m.
- Panel interactivo pesca mediterránea.

- Asientos dobles de tertulia.
- Puente de redes laterales unidas entre sí con plataforma de caucho antideslizante.

Torre doble con cubierta (HTOTAL / PLATAFORMAS = 3,76m / 1,48m y 1,20m):

- 2 Toboganes abiertos rectos de acero inoxidable H = 1,5m y 1,2m
- Panel interactivo laberinto.
- Juego interactivo Salva a Pinocho.
- Asientos dobles de tertulia.
- Acceso exterior escalera de barras.

Materiales/

- Estructuras de acero galvanizado con pintura de poliéster termoendurecido.
- Paneles de polietileno de alta densidad, libre de mantenimiento y antigraffiti.
- Plataformas, rampas y puentes en polietileno revestido de caucho antideslizante de 21mm de espesor.
- Redes de poliamida de Ø16mm con 6 almas de acero.
- Tornillería en acero inoxidable.

**Description/**

Giant multigame of dimensions 9.41m x 7.33m x 5.26m total height and 87m² game area with a marine theme. It integrates 4 slides (1 helicoidal grotto, straight grotto and 2 straight open ones) and 14 children's games distributed in 2 double triangular towers and 1 triangular. With marine themed decoration. Composition:

Double tower with cover (HTOTAL / PLATFORMS = 5.26m / 2.88m and 1.88m):

- Interactive sliding fish barrier.
- Alphabet soup panel.
- Submariner photocall.
- Exterior access stairway bars.
- Double chat room seats.
- Psychomotricity bar.
- Climbing wall access.
- Helicoidal grotto slide with 360° rotation in high-density polyethylene. H = 3m.

Central tower with roof (HTOTAL / PLATFORM = 3.76m / 1.48m):

- Straight grotto slide made of high-density polyethylene. H = 1.5m.

- Interactive Mediterranean fishing panel.
- Double chat room seats.
- Bridge of lateral nets joined together with a non-slip rubber platform.

Double tower with cover (HTOTAL / PLATFORMS = 3.76m / 1.48m and 1.20m):

- 2 straight open stainless steel slide. H = 1.5m and 1.2m
- Interactive labyrinth panel.
- Interactive game Save Pinocchio.
- Double chat room seats.
- Exterior access stairway bars.

Materials/

- Galvanized steel structures with thermosetting polyester paint.
- High-density polyethylene panels, maintenance-free and anti-graffiti.
- Platforms, ramps and bridges in polyethylene covered with non-slip rubber 21mm thick.
- Ø16mm polyamide nets with 6 steel cores.
- Stainless steel screws.

**Description/**

Grande structure multi-jeux de 3 tours avec décoration thématique sur la faune marine méditerranéenne gravée sur polyéthylène, 4 toboggans et plus de 10 jeux complémentaires, dont 7 thématiques. 88.8m² de terrain de jeu, formé par:

• Grande tour triangulaire double. Toboggan spirale fermé de 3m de haut, en polyéthylène haute densité, panneaux thématiques avec jeux, photocall et pont suspendu.

• Tour centrale triangulaire avec toboggan thématique en polyéthylène haute densité d'une hauteur de 1,5m. Dispose également de jeux thématiques complémentaires et de deux ponts reliés entre eux par une plate-forme en caoutchouc antidérapant.

- Tour triangulaire double avec deux toboggans droits ouverts inox, l'un d'entre eux d'une hauteur de 1,5m, jeux et accès.
- Toutes les tours disposent d'un toit à thème en polyéthylène haute densité thématique. Sous ce toit les enfants peuvent s'asseoir sur les bancs, ce qui leur permet de jouer, d'interagir encourageant ainsi le développement de leur habileté de communication.

Materials/

- Structure en acier galvanisé avec peinture polyester thermodurcie.
- Poteaux Ø114 et 3mm d'épaisseur.
- Panneaux en polyéthylène haute densité, sans entretien et anti-graffitis.
- Plateformes, rampes et ponts en polyéthylène revêtu de caoutchouc antidérapant de 21mm d'épaisseur.
- Filets en polyamide Ø16mm avec 6 cœurs en acier.
- Visserie en acier inoxydable.



DETALLES MULTIJUEGO / PLAYSET DETAILS / DETAILS DE LA STRUCTURE MULTIJEU



TABLERO PHOTOCALL "EL SUBMARINISTA"
PHOTOCALL PANEL "THE DIVER"
PANNEAU PHOTOCALL "LE PLONGEUR"

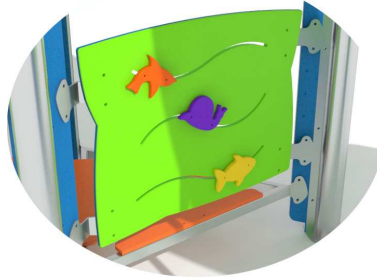

TABLERO TEMÁTICO "PECES DESLIZANTES"
THEMATIC PANEL "SLIDING FISH"
PANNEAU THÉMATIQUE "LES POISSONS COULISSANTS"



PUENTE PELDAÑOS COLGANTES
FLOATING BRIDGE
PONT SUSPENDU



TABLERO TEMÁTICO "SOPA DE LETRAS MARINA"
THEMATIC PANEL "MARINE ALPHABET SOUP"
PANNEAU THÉMATIQUE "SOUPE DE LETTRES MARINE"



TABLERO TEMÁTICO "SALVA A PINOCHO"
THEMATIC PANEL "SAVING PINOCCHIO"
PANNEAU THÉMATIQUE "SAUVER PINOCCHIO"



PUENTE REDES LATERALES Y PLATAFORMA
FLOATING BRIDGE, LATERAL ROPES AND PLATFORM
PONT SUSPENDU, CORDES LATERALES ET PLATEFORME

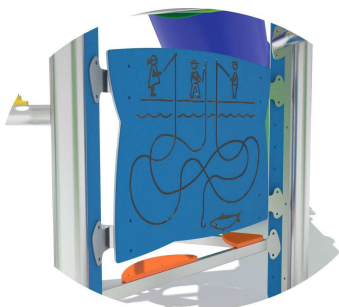

TABLERO TEMÁTICO "PESCA MEDITERRANEA"
THEMATIC PANEL "MEDITERRANEAN FISHING"
PANNEAU THÉMATIQUE "PÊCHE MÉDITERRANÉENNE"

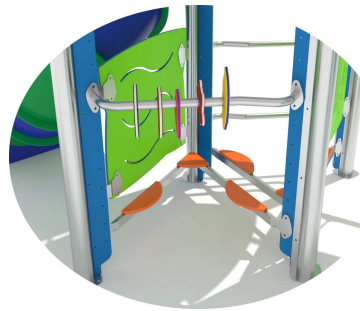

BARRA DE PSICOMOTRICIDAD MARINA
MARINE PSYCHOMOTOR BAR
BARRE PSYCHOMOTRICE TOURS

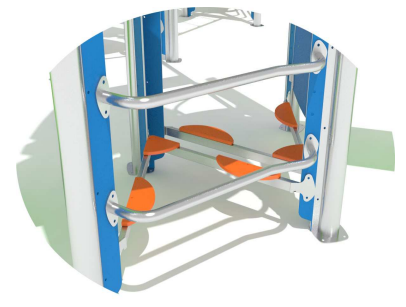

ASIENTOS EN LAS TORRES
SEATS IN TOWERS
SIÈGES AU SEIN DES TOURS

