



Descripción/ Carrusel con arcos. Juego en varias posiciones: de pie, sentados en asiento o en suelo, tumbados o reunidos.

- Materiales/**
- Estructura de acero recubierto de poliéster termoendurecido.
 - Plataforma de polietileno de alta densidad, libre de mantenimiento y antigraffiti, revestida de caucho antideslizante.
 - Asientos con asa en polietileno de alta densidad.



Description/ Carousel with archs. Several playing possibilities: standing up, sitting on seat, sitting on the floor, laying down or gathering.

- Materials/**
- Thermohardened polyester painted steel structure.
 - Antigrffiti, maintenance-free, antislippery rubber covered HDPE platform
 - HDPE seats with handles.



Description/ Manège avec arcs.

- Matériaux/**
- Structure en acier avec peinture polyester thermodurcie.
 - Plate-forme en polyéthylène haute densité sans entretien et antigraffiti avec un revêtement en caoutchouc antidérapant
 - Sièges avec des anses en polyéthylène haute densité.

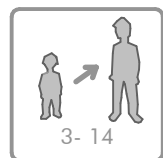
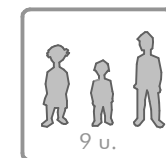
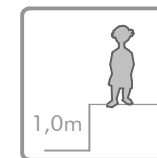
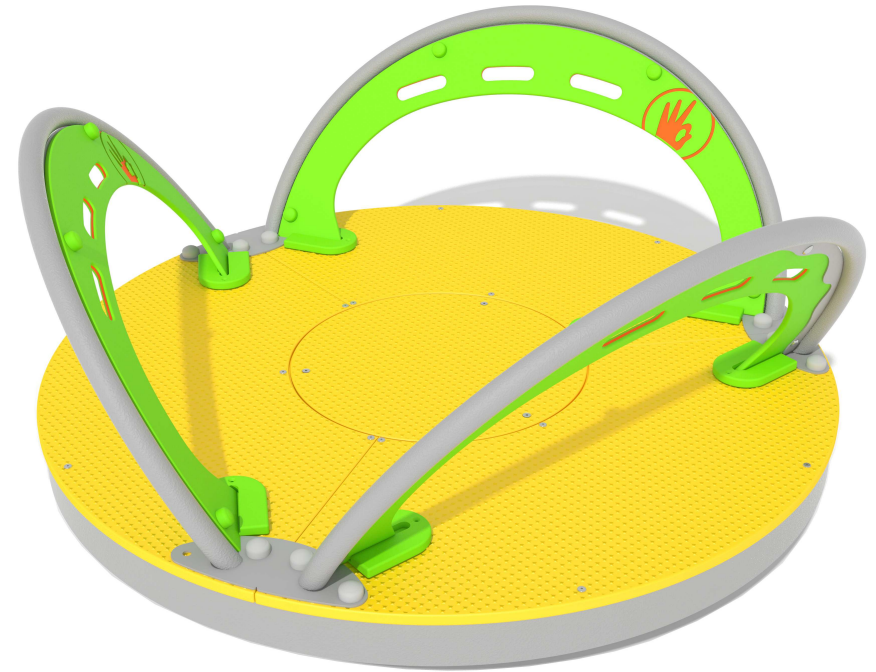

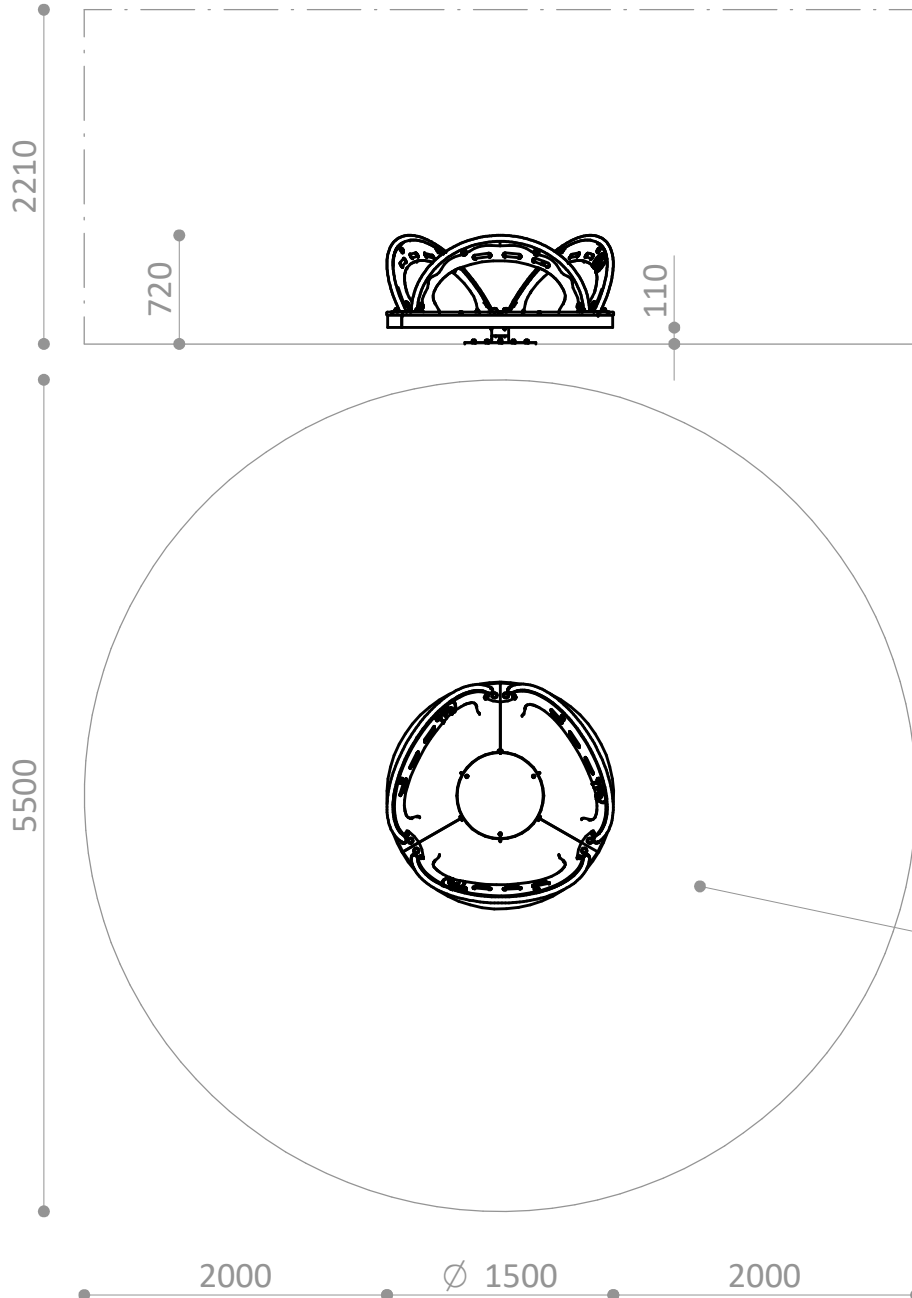

R4501

Pieza más grande

Biggest part

La plus grande pièce



R4501

Pieza más pesada

Heaviest part

La pièce la plus lourde



130 Kg

R4501A

Suelo de hormigón

Concrete ground

Fixation sur béton

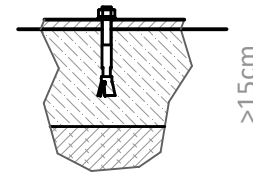

x6

R4501E

Otros suelos

Other grounds

Autres sols

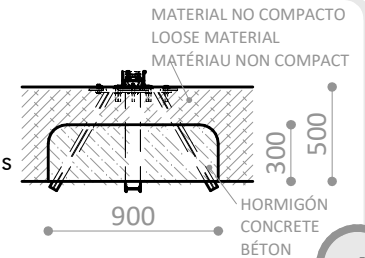

x1

ESPACIO DE SEGURIDAD / ALTURA DE CAIDA LIBRE
SAFETY AREA / FREE HEIGHT OF FALL
ZONE DE SÉCURITÉ / HAUTEUR DE CHUTE LIBRE

24 m² / 1,0 m

Superficie según EN-1176-5
Surface according to EN-1176-5
Revêtement conformément à la Norme EN-1176-5

Disponibilidad de repuestos durante 10 años.
Spare parts available for 10 years.
Disponibilité de pièces de rechange pendant 10 ans.

Industrias Agapito se reserva el derecho a modificar sin previo aviso los elementos descritos en este documento.
Industrias Agapito reserves the right to change the items described in this document without prior notice.
Industrias Agapito se réserve le droit de modifier à tout moment et sans préavis les éléments décrits dans le présent document.

No conforme con EN-1176-5
Not EN-1176-5 compliant
Non conforme à la Norme EN-1176-5

