

 **Descripción/** Juego de muelle, 1 plaza.

- Materiales/**
- Estructura de polietileno de alta densidad, libre de mantenimiento y antigraffiti.
 - Asiento recubierto de goma antideslizante.
 - Muelle antipinzamiento con recubrimiento de pintura en polvo de poliéster termoendurecida.

 **Description/** Spring rider, 1 seat.

- Materials/**
- Maintenance-free, anti-graffiti, HDPE structure.
 - Anti-slippery rubber covered HDPE seat.
 - Spring with anti-pinch design and covered with a thermohardened polyester powder paint.

 **Description/** Jeu à ressort, 1 place.

- Matériaux/**
- Structure en polyéthylène haute densité, sans entretien et antigraffiti.
 - Siège en polyéthylène haute densité avec un revêtement anti dérapant.
 - Ressort en acier avec système anti-pincement et peinture polyester thermodurcie..

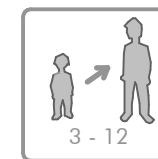
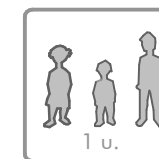
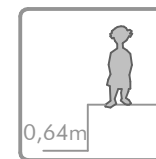
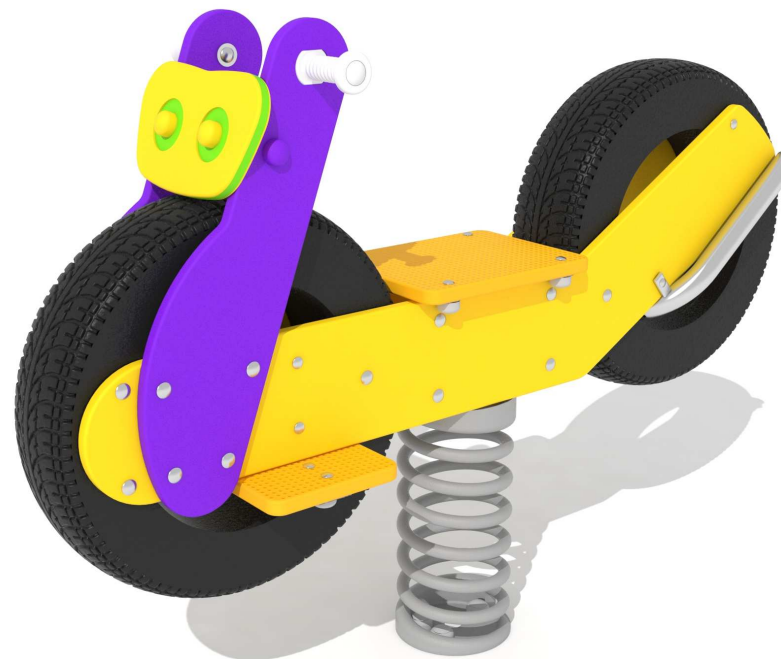

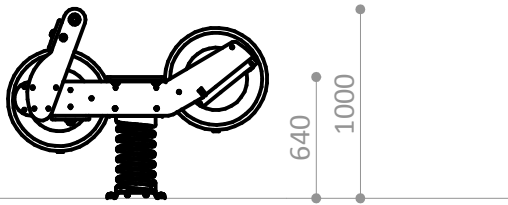

ESPACIO DE SEGURIDAD / ALTURA DE CAÍDA A LIBRE
SAFETY AREA / FREE HEIGHT OF FALL
ZONE DE SÉCURITÉ / HAUTEUR DE CHUTE LIBRE

A -10,70 m² / 0,64 m

Superficie según EN-1176-1
Surface according to EN-1176-1
Revêtement conformément à la Norme EN-1176-1

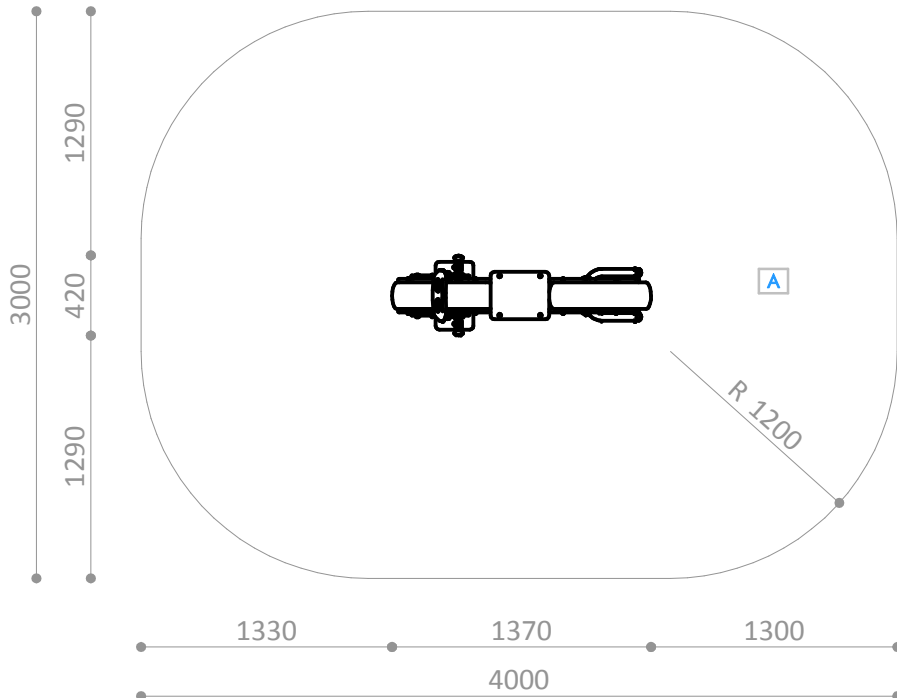

R4620

Pieza más grande

Biggest part

La plus grande pièce

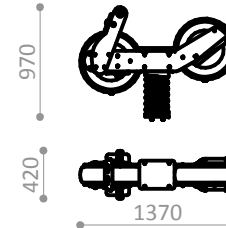

R4620

Pieza más pesada

Heaviest part

La pièce la plus lourde



54 Kg.

R4620A

Suelo de hormigón

Concrete ground

Fixation sur béton

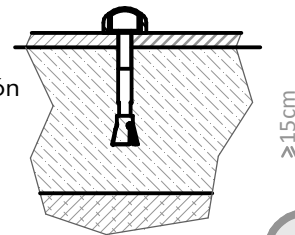

x4

R4620E

Otros suelos

Other grounds

Autres sols

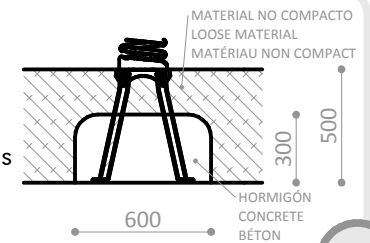

x1

Disponibilidad de repuestos durante 10 años.
Spare parts available for 10 years.
Disponibilité de pièces de rechange pendant 10 ans.

Industrias Agapito se reserva el derecho a modificar sin previo aviso los elementos descritos en este documento.
Industrias Agapito reserves the right to change the items described in this document without prior notice.
Industrias Agapito se réserve le droit de modifier à tout moment et sans préavis les éléments décrits dans le présent document.



AGAPLAY

R4620

LA GRAN MOTO
BIG MOTORBIKE
LA GRANDE MOTO

FICHA TECNICA
TECHNICAL SHEET
FICHE TECHNIQUE
FT-R4620rev06 - 3/3

