

 **Descripción/** Mesita de reunión y tertulia para amigos con dos bancos.

- Materiales/**
- Estructura de Pino Rojo del Norte tratado en autoclave y acabada con lásur, protector de la madera a poro abierto, hidrófugo, fungicida y con doble filtro anti U.V.
 - Paneles de polietileno de alta densidad, libre de mantenimiento y antigraffiti.

 **Description/** Game table with 2 benches.

- Materials/**
- P4 Vacuum pressure treated Pine wood structure, with open pore, waterproof, fungicide and ultraviolet radiation protection.
 - Maintenance-free, anti-graffiti, HDPE panels.

 **Description/** Petite table de réunion avec 2 bancs.

- Matériaux/**
- Structure en Pin du Nord Pin du Nord, traité en autoclave et finition lasurée, protecteur du bois à pores ouverts, hydrofuge, fongicide et avec double protection U.V.
 - Panneaux en polyéthylène haute densité, sans entretien et antigraffiti.

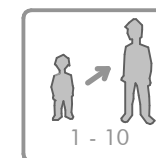
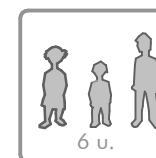
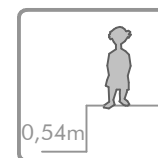
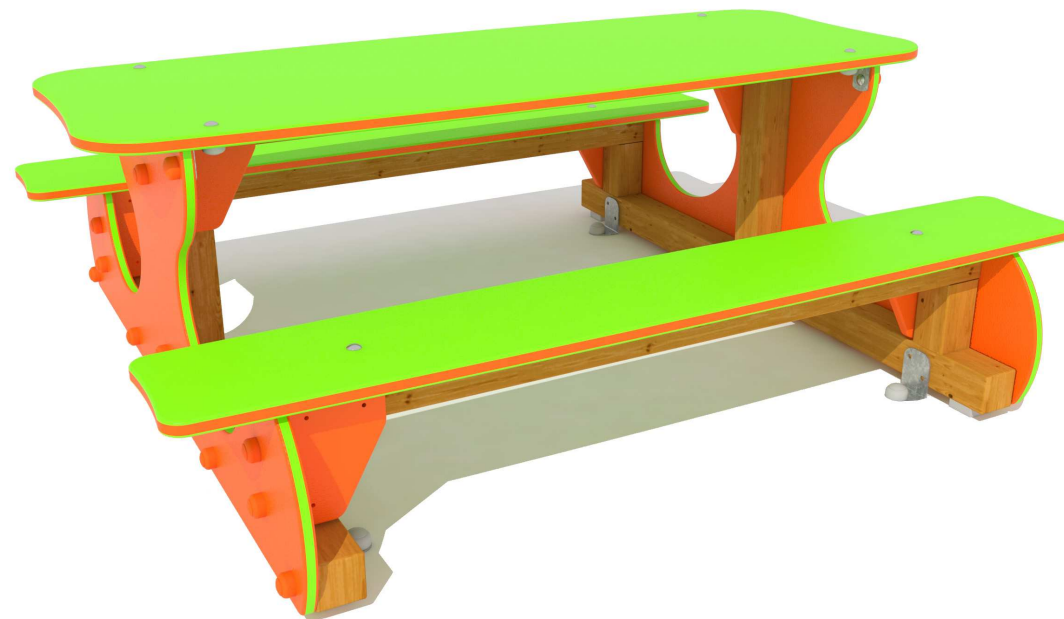

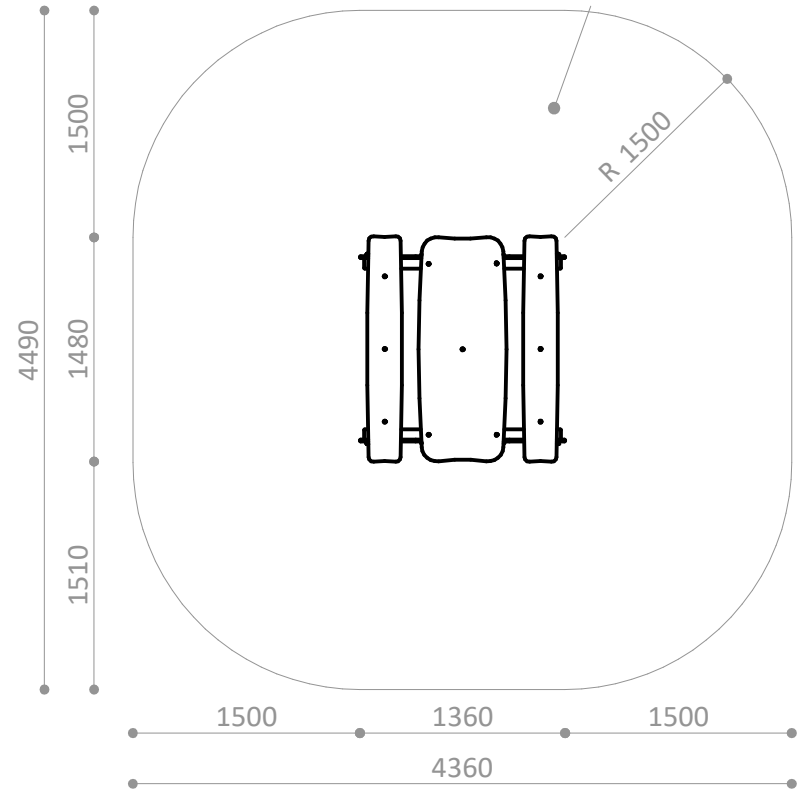

MESA R5028E

Pieza más grande

Biggest part

La plus grande pièce

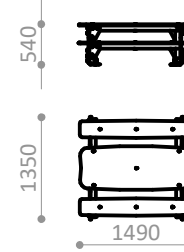

R5028E MESA

Pieza más pesada

Heaviest part

La pièce la plus lourde

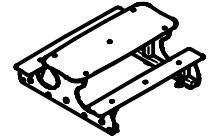

R5028A

Suelo de hormigón

Concrete ground

Fixation sur béton

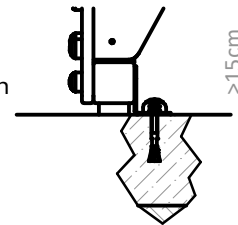

x4

R5028E

Otros suelos

Other grounds

Autres sols

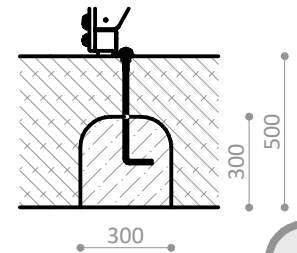

x4

Disponibilidad de repuestos durante 10 años.
Spare parts available for 10 years.
Disponibilité de pièces de rechange pendant 10 ans.

Industrias Agapito se reserva el derecho a modificar sin previo aviso los elementos descritos en este documento.
Industrias Agapito reserves the right to change the items described in this document without prior notice.
Industrias Agapito se réserve le droit de modifier à tout moment et sans préavis les éléments décrits dans le présent document.



AGAPLAY

R5028

MESITA VELETA
VELETA TABLE
TABLE VELETA

FICHA TECNICA
TECHNICAL SHEET
FICHE TECHNIQUE
FT-R5028rev03 - 3/3

