 **Descripción/** Casita Spooky Tragona. Incluye ventanas, bancos y laterales con decoraciones grabadas.

- Materiales/**
- Polietileno de alta densidad, libre de mantenimiento y antigraffiti.
 - Partes metálicas en acero galvanizado

 **Description/** Big Eater Spooky Little House. It includes windows, benches and side walls with engraved panels.

- Materials/**
- Antigraffiti, maintenance-free HDPE.
 - Galvanized steel parts.

 **Description/** Petite Maison Spooky Gloutonne. Avec fenêtres, sièges et décoration gravée.

- Matériaux/**
- Polyéthylène haute densité, sans entretien et antigraffiti.
 - Pièces métalliques en acier galvanisé.

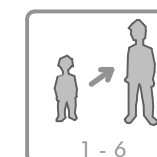
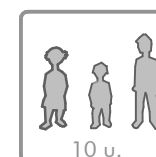
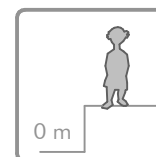
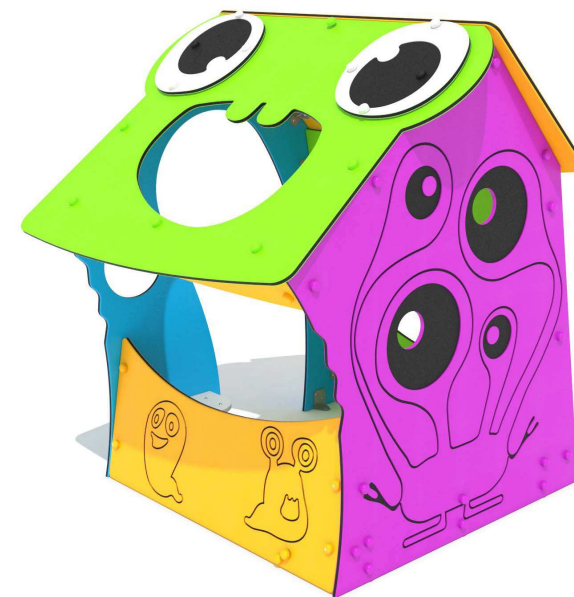

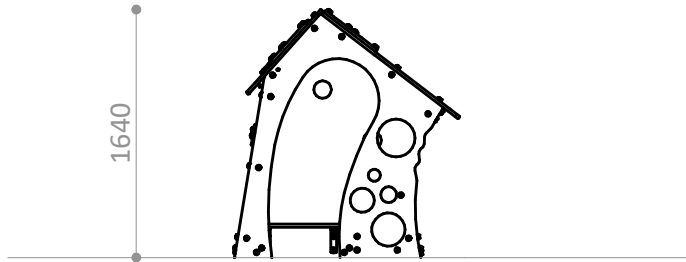

ESPACIO DE SEGURIDAD / ALTURA DE CAIDA LIBRE
SAFETY AREA / FREE HEIGHT OF FALL
ZONE DE SECURITÉ / HAUTEUR DE CHUTE LIBRE

18,50 m² / 0 m

Superficie según EN-1176-1
Surface according to EN-1176-1
Revêtement conformément à la Norme EN-1176-1

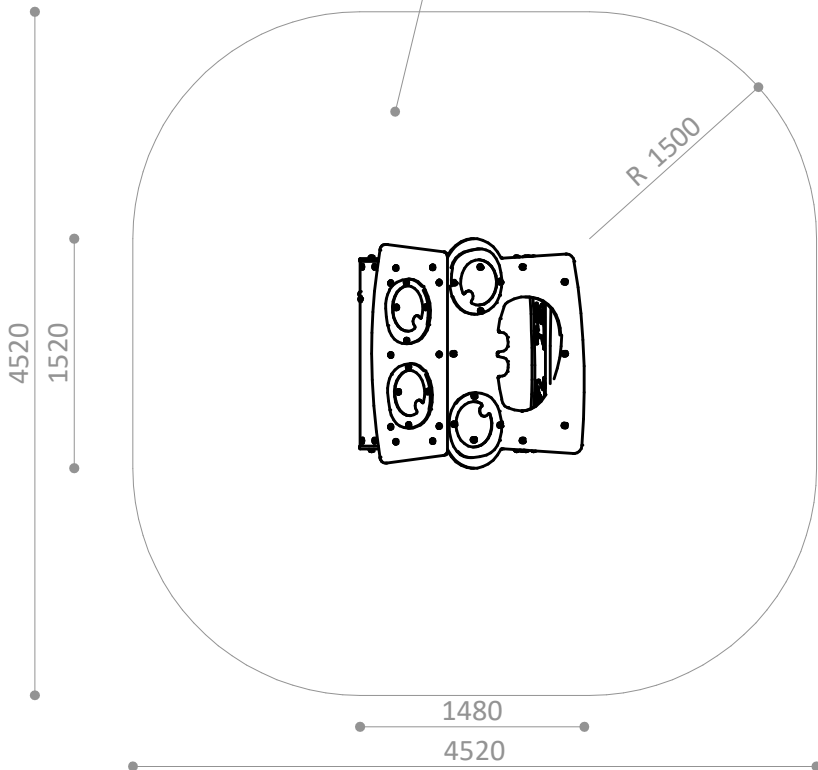

R5056

Pieza más grande

Biggest part

La plus grande pièce



R5056

Pieza más pesada

Heaviest part

La pièce la plus lourde

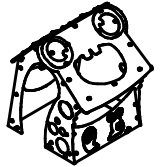

157 Kg.

R5056A

Suelo de hormigón

Concrete ground

Fixation sur béton

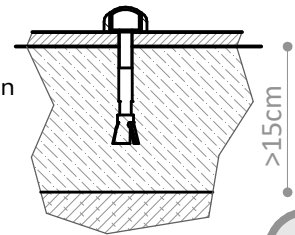

x4

R5056E

Otros suelos

Other grounds

Autres sols

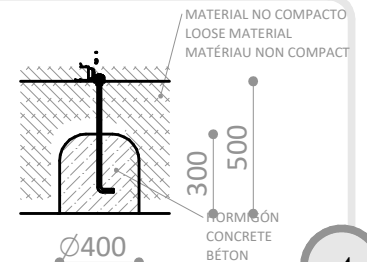

x4

Disponibilidad de repuestos durante 10 años.
Spare parts available for 10 years.
Disponibilité de pièces de rechange pendant 10 ans.

Industrias Agapito se reserva el derecho a modificar sin previo aviso los elementos descritos en este documento.
Industrias Agapito reserves the right to change the items described in this document without prior notice.
Industrias Agapito se réserve le droit de modifier à tout moment et sans préavis les éléments décrits dans le présent document.

