



**Función/** 4 barras de distintas alturas conformando un cuadrilátero.  
Sólo un usuario en cada elemento.  
Realizar el ejercicio centrado en el elemento.

**Materiales/**

- Barras de acero galvanizado con acabado en pintura de poliéster termoendurecida.
- Postes de acero galvanizado en caliente.
- Tornillería antivandálica de acero inoxidable.
- Pictograma explicativo de uso grabado en tablero de polietileno de alta densidad bicolor.



**Function/** 4 bars of different heights, forming a quadrilateral.  
Only one user per bar.  
The exercise has to be done centered on the bar.

**Materials/**

- Galvanized steel bars finished with thermoset polyester paint.
- Hot-dip galvanized steel posts.
- Anti-vandal stainless steel bolts.
- Explanatory usage board with pictograms engraved in two-color HDPE.



**Fonction/** 4 barres de hauteurs différentes formant un quadrilatère. Un seul utilisateur sur chaque barre.  
L'exercice s'effectue centré sur la barre.

**Matériaux/**

- Barres en acier galvanisé et finition avec peinture polyester thermodurcie.
- Poteaux en acier galvanisés à chaud.
- Visserie antivandalisme en acier inoxydable.
- Pictogrammes explicatifs d'utilisation gravés sur panneau de polyéthylène haute densité bicolore.

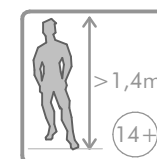
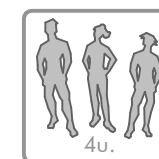
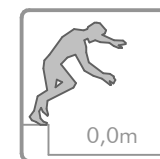
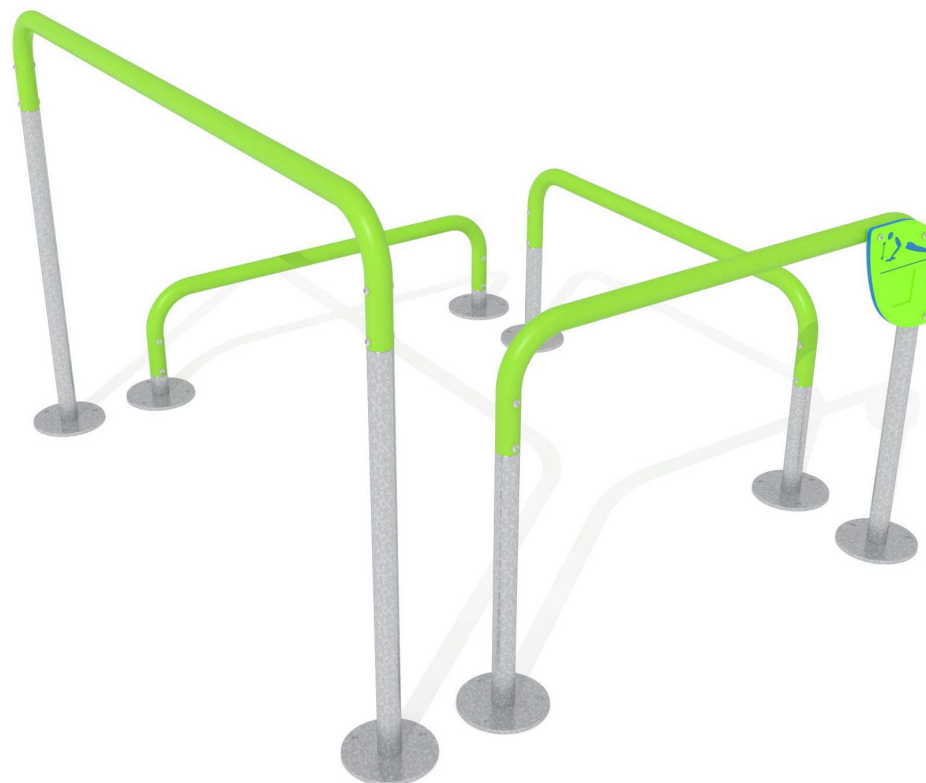

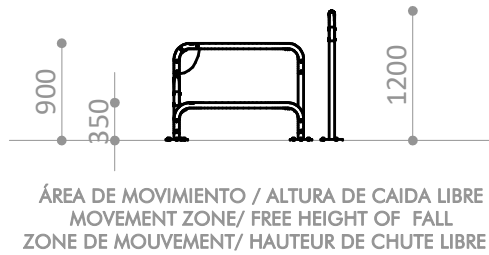

19,40 m<sup>2</sup> / 0,00 m

Superficie según EN 16630  
Surface according to EN 16630  
Revêtement conformément à la Norme EN 16630

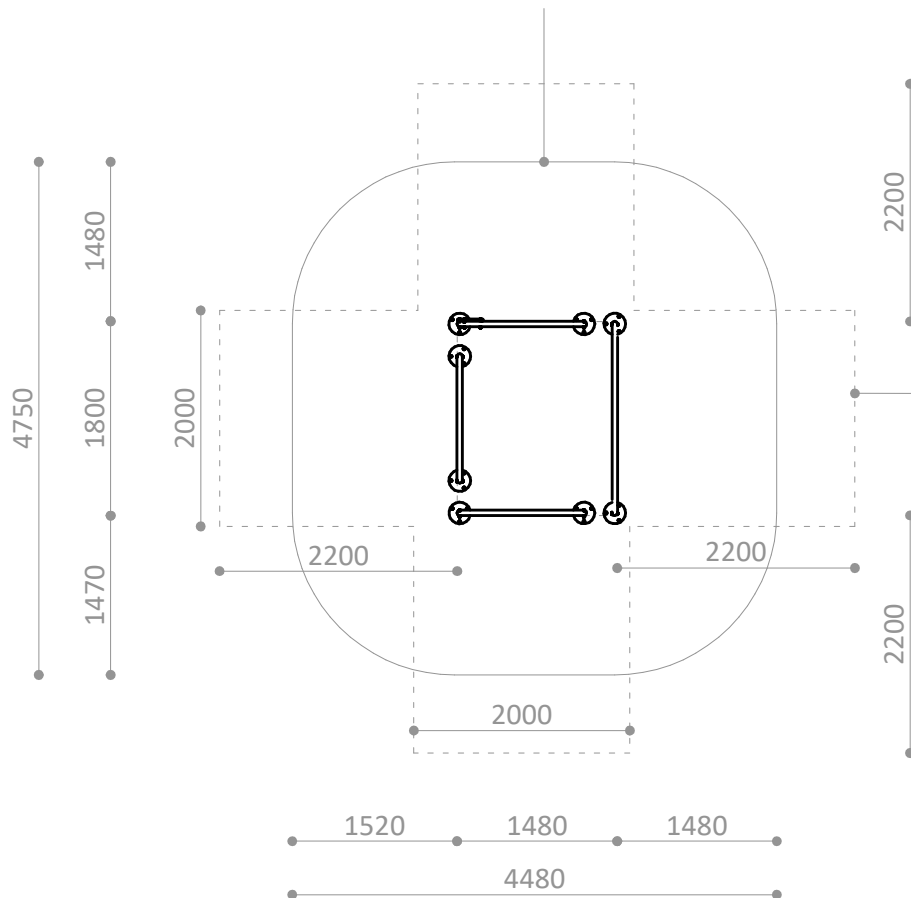

PIEZA MAS GRANDE

BIGGEST PART

LA PLUS GRANDE PIECE

R7410A-05

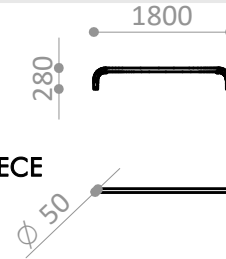

PIEZA MAS PESADA

HEAVIEST PART

LA PIECE LA PLUS LOURDE

R7410A-05



5 Kg.

R7428A

Suelo de hormigón

Concrete ground

Fixation sur béton

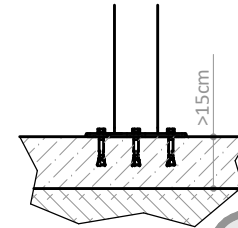

x24

R7428E

Otros suelos

Other grounds

Autres sols

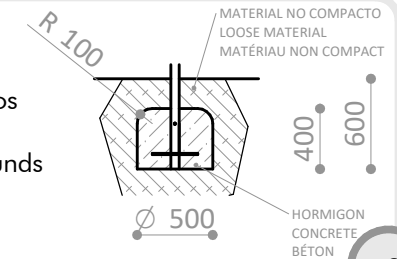

x8

ÁREA DE EJERCICIO  
EXERCISE ZONE  
ZONE D'EXERCICE

Disponibilidad de repuestos durante 10 años.  
Spare parts available for 10 years.  
Disponibilité de pièces de rechange pendant 10 ans.  
10 Jahre Ersatzteilverfügbarkeit

Industrias Agapito se reserva el derecho a modificar sin previo aviso los elementos descritos en este documento.  
Industrias Agapito reserves the right to change the items described in this document without prior notice.  
Industrias Agapito se réserve le droit de modifier à tout moment et sans préavis les éléments décrits dans le présent document.  
Industrias Agapito behält sich das Recht vor, die in diesem Dokument beschriebenen Elemente ohne vorherige Ankündigung zu verändern.

Peso máximo del usuario = 150 Kg.  
Maximum user weight = 150 Kg.  
Poids maximum de l'utilisateur = 150 Kg  
Höchstgewicht des Benutzers = 150 Kg



