

ES TERMOSTATO LITE CABLE

Termostato con botones capacitivos y acabado en acero y cristal, para el control de temperatura de zona en un sistema Airzone. Comunicaciones vía cable. Alimentado a través de la central del sistema. Disponible en blanco y negro.

Funcionalidades:

- On/Off de la zona.
- Control de temperatura de consigna, en pasos de 1°C, hasta un máximo de ±3°C.
- Lectura de la temperatura ambiente y humedad relativa.

Para más información de nuestros productos remítase a myzone.airzone.es

EN WIRED LITE THERMOSTAT

Thermostat with capacitive buttons for controlling the temperature of the zones in Airzone systems. Finished in steel and glass. Wired communications. Powered by main control board. Available in white and black.

Functionalities:

- On/off of the zone.
- Set-point temperature control (Accuracy: ± 1°C, up to a limit of ±3°C.)
- Room temperature and relative humidity reading.

For further information about our products, go to myzone.airzone.es

PT TERMOSTATO LITE CABO

Termostato com botões capacitivos e acabamento em aço e cristal para controlo de temperatura de zona em sistema Airzone. Comunicação via cabo. Alimentado através da central do sistema. Disponível em branco e preto.

Funcionalidades:

- On/Off da zona.
- Controlo de temperatura de referência, em intervalos de 1°C, até máximo de ±3°C.
- Leitura da temperatura ambiente e humidade relativa.

Para obter mais informações sobre nossos produtos, consulte myzone.airzone.es

AZRA6LITEC [B/N]



- RadianT

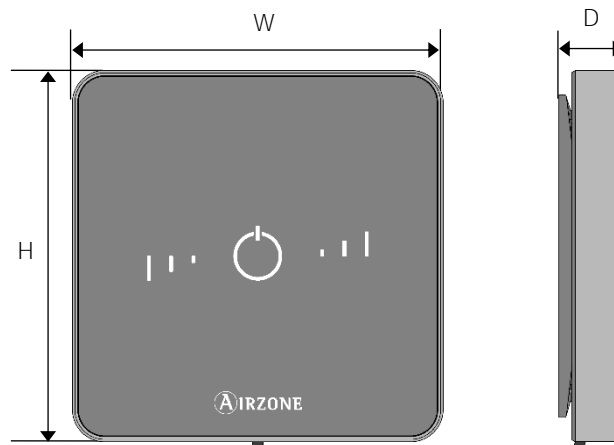

(ES) CARACTERÍSTICAS TÉCNICAS / (EN) TECHNICAL SPECS / (PT) CARACTERÍSTICAS TÉCNICAS

Alimentación y consumo / Power supply and consumption Alimentação e consumo	
Tipo de alimentación / Type of power supply / Tipo de alimentação	Vdc
V max	12 V
I max	25 mA
Consumo Stand-by / Stand-by consumption / Consumo em stand-by	240 mW
Conexión y comunicaciones / Connection and communications Conexão y comunicação	
Tipo de cable / Type of cable / Tipo de cabo	Trenzado y apantallado Shielded twisted pair Trançado e blindado
Hilos de comunicación / Communication wires Fios de comunicação	2 x 0,22 mm ²
Hilos de alimentación / Power supply wires Fios de alimentação	2 x 0,5 mm ²
Distancia máxima / Maximum distance / Distância máxima	40 m
Temperaturas operativas / Operating temperatures Temperaturas de operação	
Almacenaje / Storage / Armazenamento	-20 ... 70 °C
Funcionamiento / Operation / Funcionamento	0 ... 50°C
Rango de humedad de funcionamiento / Operating humidity range / Intervalo de humidade de funcionamento	5...90% (sin condensación) (non-condensing) (sem condensação)
Rango de temperatura de consigna / Set-point temperature range / Intervalo da temperatura de referência	15 ... 30°C
Precisión de lectura / Reading accuracy Precisão de leitura	±0,1 °C
Humedad relativa / Relative humidity / Humidade relativa	± 4 %
Aspectos mecánicos / Mechanical aspects / Aspectos mecânicos	
Montaje / Assembly / Montagem	En superficie mediante soporte Surface through support Em superfície mediante suporte
Grado de protección / Protection class / Grau de proteção	IP 20
Tipo de sonda / Type of probe / Tipo de sonda	Airzone_NTC_10K
Peso / Weight / Peso	186 g
Dimensiones / Size / Dimensões (WxHxD)	92x 92x15,85 mm





(ES) MONTAJE / (EN) ASSEMBLY / (PT) MONTAGEM

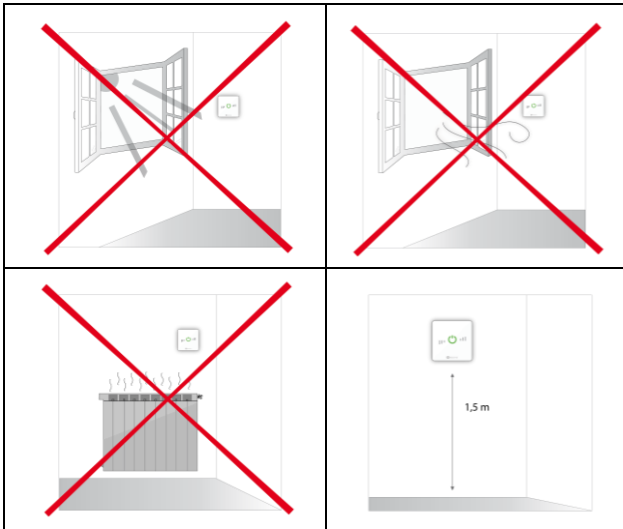
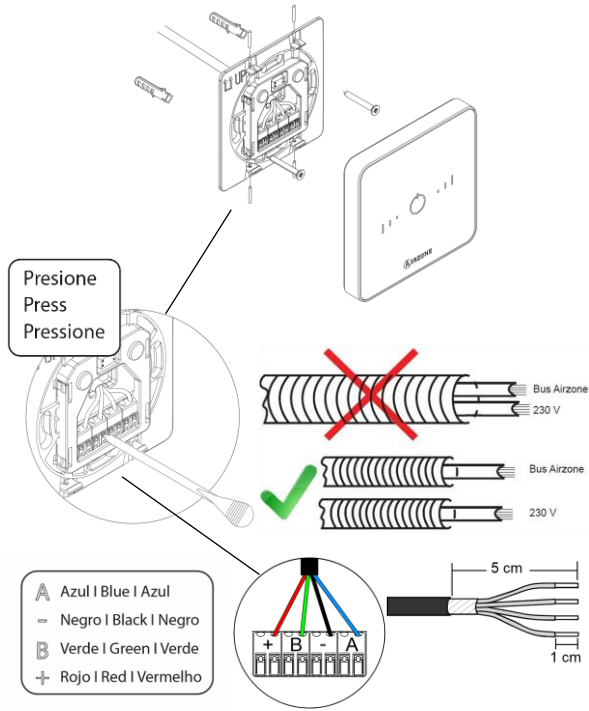

(ES) FUNCIONALIDADES / (EN) FUNCTIONALITIES / (PT) FUNCIONALIDADES

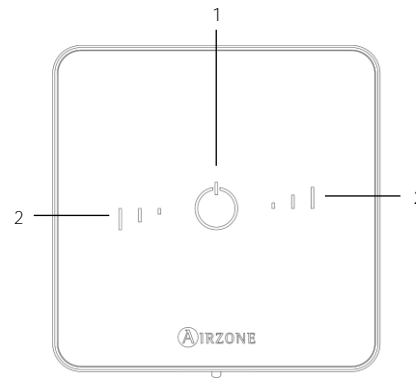

Nº	Significado / Meaning / Significado	
1	<p>Si el led está fijo la zona está encendida If the LED is fixed, the zone is activated Se o led está fixo, a zona está ativa</p> <p>Si el led está parpadeando la zona está apagada If the LED is flashing the zone is deactivated Se o led estiver piscando, a zona está desativada</p>	<p>Modo de funcionamiento: - Morado: Stop - Rojo: Calor - Azul: Frio - Verde: Consigna</p> <p>Operation mode: - Purple: Stop - Red: Heating - Blue: Cooling - Green: Set-point</p> <p>Modo de funcionamento: - Roxo: parado - Vermelho: calor - Azul: frio - Verde: referência</p>
2	<p>Si el led está encendido indica desfase de la temperatura de consigna con respecto a la temperatura base (1 led = $\pm 1^\circ\text{C}$) If the led is on, it indicates there is a temperature gap between the set-point temperature and the base temperature (1 led = $\pm 1^\circ\text{C}$) Se o led estiver aceso, existe um desfase da temperatura de referência em relação à temperatura base (1 led = $\pm 1^\circ\text{C}$)</p> <p>Si el led parpadea indica que ha llegado a la temperatura límite establecido por el Eco-Adapt If the led blinking it, indicates it has reached the temperature limit set by the Eco-Adapt function Se o led piscar, a temperatura limite estabelecida pelo Eco-Adap foi atingida</p>	



(ES) AUTODIAGNÓSTICO / (EN) SELF-DIAGNOSIS / (PT) AUTODIAGNÓSTICO

Significado / Meaning / Significado		
	<p>Parpadeo rápido rojo Blinking red quickly Piscadas vermelhas rápidas</p>	<p>Error de comunicaciones con la central Error of communication with main control board Erro de comunicação com a central</p>



(ES) CONEXIÓN / (EN) CONNECTION / (PT) CONEXÃO

(ES) Seleccione la zona a controlar mediante el microswitch
(EN) Select the zone to be controlled through microswitch
(PT) Selecione a zona a ser controlada através do microinterruptor

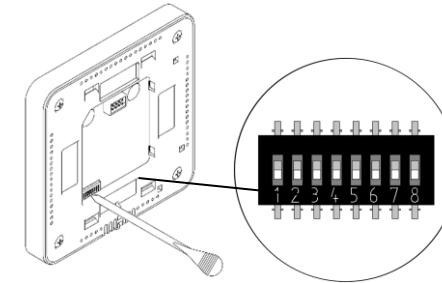

(ES) No conectar polo "-" en borna "+". Puede dañar el dispositivo.
(EN) Do not connect the "-" pole to the "+" terminal. It may damage the device.
(PT) Não conectar pólo "-" em terminal "+". Pode danificar o dispositivo.

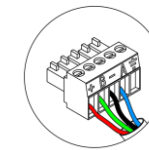

A Azul | Blue | Azul
- Negro | Black | Negro
B Verde | Green | Verde
+ Rojo | Red | Vermelho

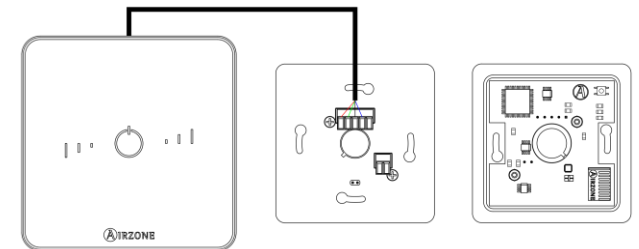

Significado / Meaning / Significado		
	<p>5 parpadeos verde Blinking green 5 times 5 piscadas verdes</p>	<p>Asociación correcta Correct association Associação correta</p>
	<p>1 parpadeo rojo Blinking red once 1 piscada vermelha</p>	<p>Zona ocupada Occupied zone Zona ocupada</p>
	<p>2 parpadeos rojo Blinking red twice 2 piscadas vermelhas</p>	<p>Termostato fuera de cobertura Thermostat out of range Termostato fora de cobertura</p>



THERMOSTAT LITE FILAIRE

Thermostat disposant de touches capacitives et finition en acier et en verre, pour le **contrôle de la température d'une zone dans un système Airzone**. Communications via câble. Alimenté au travers de la platine centrale du système. Disponible en noir et en blanc.

Fonctionnalités :

- On / Off de la zone.
- Modification de la température de consigne déjà assignée par pas de 1°C, jusqu'à un maximum de $\pm 3^\circ\text{C}$.
- Lecture de la température ambiante et de l'humidité relative.

Pour plus d'informations sur nos produits, veuillez vous rendre sur la page myzone.airzonefrance.fr



TERMOSTATO LITE CABLATO

Termostato con tasti capacitivi e finitura in acciaio vetro per il controllo della temperatura in un sistema Airzone. Comunicazione via cavo con la scheda centrale. Alimentazione diretta dalla scheda centrale del sistema. Disponibile nei colori bianco e nero.

Funzionalità:

- On/Off della zona.
- Controllo della temperatura desiderata con passo di 1°C fino a un massimo di $\pm 3^\circ\text{C}$.
- Lettura della temperatura ambiente e dell'umidità relativa.

Per maggiori informazioni sui nostri prodotti utilizzi il nostro sito dedicato myzone.airzoneitalia.it



LITE-KABELTHERMOSTAT

Thermostat mit berührungsempfindlichen Tasten, Ausführung in Stahl und Glas, für die Bereichssteuerung in Airzone-Systemen. Verbindung über Kabel. Betätigung durch die Systemzentrale. Lieferbar in Schwarz oder Weiß.

Funktionsumfang:

- Ein/Aus des Bereichs.
- Steuerung der Solltemperatur in Schritten von 1°C bis max. $\pm 3^\circ\text{C}$.
- Ablesen der Raumtemperatur und relativen Luftfeuchtigkeit.

Weitere Informationen über unsere Produkte siehe myzone.airzone.es

AZRA6LITEC [B/N]



- RadianT

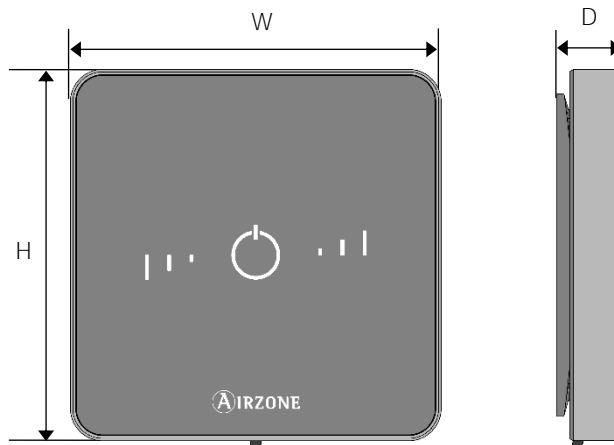

(FR) CARACTÉRISTIQUES TECHNIQUES

(IT) CARATTERISTICHE TECNICHE

(DE) TECHNISCHE DATEN

Alimentation et consommation / Alimentazione e consumo Stromversorgung und Verbrauch	
Type d'alimentation / Tipo di alimentazione/ Versorgungsart	Vdc
	V max 12 V
	I max 25 mA
Consommation Stand-by / Consumo Stand-by Stand-by-Leistungsaufnahme	240 mW
Connexions et communications / Collegamenti e comunicazione Anschluss und Verbindungen	
Type de câble / Tipo di cavo / Kabeltyp	Torsadé et blindé Trecciato e schermato Umflochten und abgeschirmt
Fils de communications / Poli di comunicazione Kommunikationsleitung	2 x 0,22 mm ²
Fils d'alimentation / Poli di alimentazione Versorgungsleitung	2 x 0,5 mm ²
Distance maximale / Distanza massima / Max. Abstand	40 m
Températures opératives / Temperature operative Betriebstemperaturen	
De stockage / Stoccaggio / Lagerung	-20 ... 70 °C
De fonctionnement / Funzionamento / Betrieb	0 ... 50°C
Plage d'humidité de fonctionnement / Rango di umidità di funzionamento / Zulässige Luftfeuchtigkeit	5...90% (sans condensation) (senza condensazione) (nicht-kondensierend)
Plage de température de consigne / Rango di temperature impostabile / Solltemperaturbereich	15 ... 30°C
Précision de lecture / Precisione di lettura Ablesegenauigkeit	$\pm 0,1^\circ\text{C}$
Humidité relative / Umidità relativa Relative Luftfeuchtigkeit	$\pm 4\%$
Aspects mécaniques / Aspetti meccanici / Mechanische Aspekte	
Montage / Montaggio / Montage	En surface au moyen d'un support In superficie mediante supporto Oberfläche mittels Halterung
Degré de protectio / Grado di protezione/ Schutzklasse	IP 20
Type de sonde / Tipo di sonda / Sondentyp	Airzone_NTC_10K
	Poids / Peso / Gewicht 186 g
Dimensions / Dimensioni / Abmessungen (WxHxD)	92x 92x15,85 mm





(FR) MONTAGE / (IT) MONTAGGIO / (DE) MONTAGE

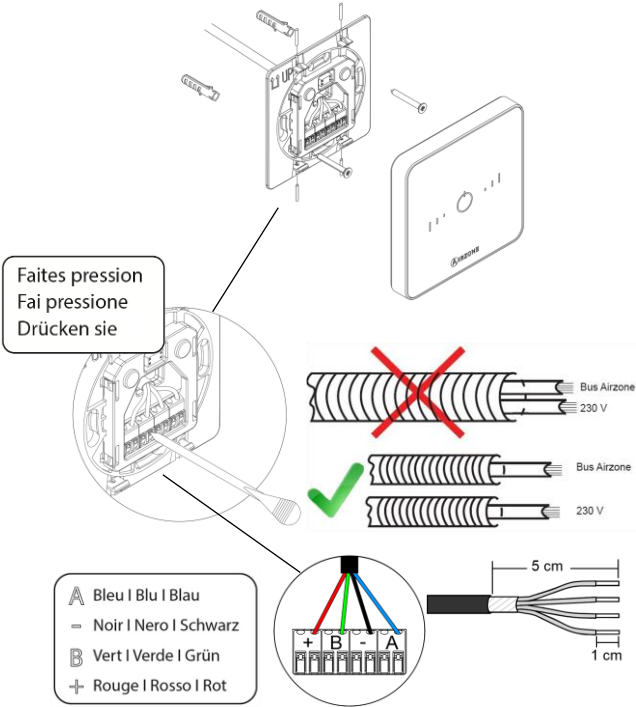

- A Bleu | Blu | Blau
- Noir | Nero | Schwarz
- B Vert | Verde | Grün
- + Rouge | Rosso | Rot

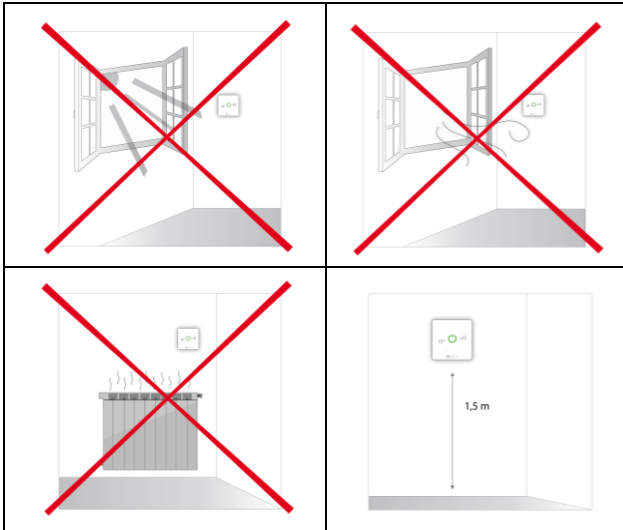

(FR) FONCTIONNALITES / (IT) FUNZIONALITA' / (DE) FUNKTIONSUMFANG

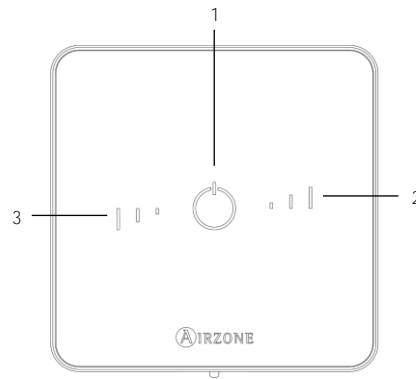

N°	Signification / Significato / Bedeutung	
1	Si la LED est fixe, la zone est activée Se il led è fisso la zona è accesa Wenn die LED fest leuchtet, ist der Bereich eingeschaltet	Mode de fonctionnement : - Violet : Stop - Rouge : Chauffage - Bleu : Refroidissement - Vert : Consigne Modo di funzionamento: - Vioia: Stop - Rosso: Caldo - Blu: Freddo - Verde: Temperatura raggiunta
	Si la LED clignote, la zone est désactivée Se il led lampeggia la zona è spenta Wenn die LED blinkt, ist der Bereich ausgeschaltet	Funktionsmodus: - Violett: Stopp - Rot: Wärme - Blau: Kalt - Grün: Sollwert
2	Si la LED est allumée, elle indique une variation de la température de consigne par rapport à la température de base (1 LED = ±1°C) Se il led è acceso indica un settaggio della temperatura richiesta rispetto alla temperatura base (1 led = ±1°C) Wenn die LED leuchtet, wird Abweichung zwischen Solltemperatur und Grundtemperatur angezeigt (1 led = ±1°C)	
3	Si la LED clignote, elle indique que la zone est arrivée à la température limite établie par la fonction Eco-Adapt. Se il led lampeggia indica che si è raggiunta la temperatura limite impostabile da Eco-Adapt Wenn die LED blinkt, wird angezeigt, dass die vom Eco-Adapt festgelegte Grenztemperatur erreicht ist	



(FR) AUTODIAGNOSTIC / (IT) AUTODIAGNOSI / (DE) SELBSTDIAGNOSE

Signification / Significato / Bedeutung	
	Clignotement rapide rouge lampeggio rapido rosso Schnelles Blinken rot
	Erreur de communication avec la platine centrale Errore di comunicazione con la centrale Fehler Kommunikation mit Zentrale



(FR) CONNEXION/ (IT) COLLEGAMENTI / (DE) VERBINDUNG

(FR) Sélectionnez la zone à contrôler au moyen d'un microswitch
(IT) Selezionare la zona da controllare mediante i microswitch
(DE) Wählen Sie den zu steuernden Bereich über den Mikroschwich aus

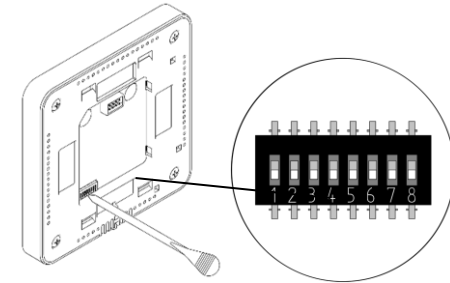

(FR) Ne pas connecter le pôle "-" dans la borne "+". Cela peut endommager le dispositif.
(IT) Non collegare il polo "-" nel connettore "+". Potrebbe danneggiare il dispositivo.
(DE) Minuspol nicht an Plusklemme anschließen. Kann das Gerät beschädigen.

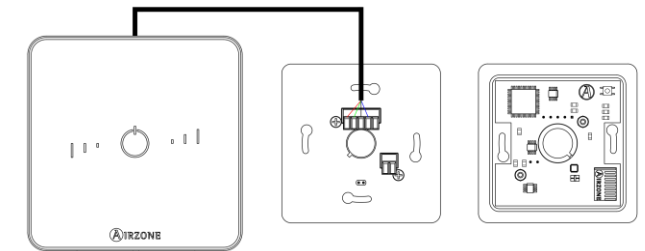
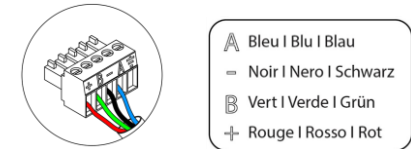

Signification / Significato / Bedeutung		
	5 clignotements verts 5 lampeggi verdi 5 mal Blinken grün	Association correcte Associazione corretta Kopplung erfolgt
	1 clignotement rouge 1 lampeggio rosso 1 mal Blinken rot	Zone occupée Zona occupata Bereich besetzt
	2 clignotements rouges 2 lampeggi rossi 2 mal Blinken rot	Thermostat hors réseau Termostato fuori copertura radio Thermostat außer Reichweite