

## Air Cooled chiller with scroll compressors

### EWAT~B-

Vintage B

BLUEEVOLUTION

- Nominal capacity range 81 - 701 kW
- 2 efficiency levels
- 3 sound configuration
- Full packaged solution
- R-32 refrigerant

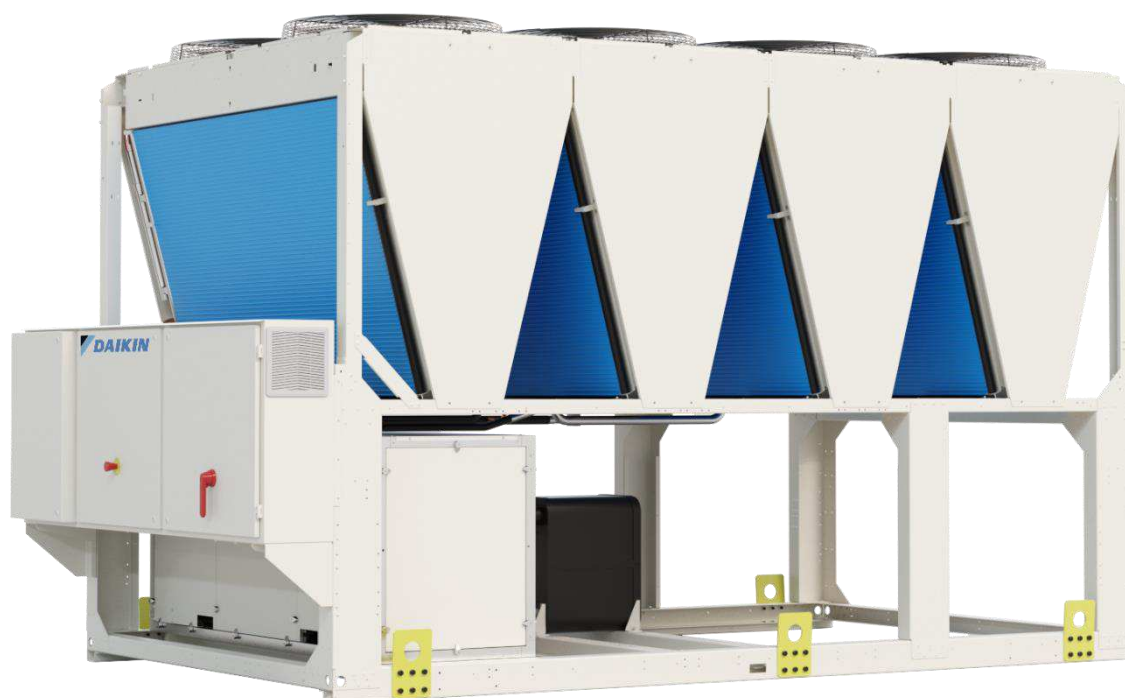

Performance according to EN14511.



[www.eurovent-certification.com](http://www.eurovent-certification.com)



**Low operating cost.**

The new Daikin *BLUEEVOLUTION* chiller series (EWAT-B-) is the result of careful design aimed to optimize the energy efficiency and thus the total life cycle cost of the chiller, with reduced operating cost thanks to outstanding performances and reliability.

The chillers feature high efficiency scroll compressor arranged in tandem or trio configuration on each refrigerant circuit, optimized condensing section with advanced technology condensing fans and plates evaporator with low refrigerant content and reduced pressure drops. New Vintage B fully compliant with Ecodesign Lot 21 Tier 2 (Regulation 2016/2281).

**Low environmental impact.**

Latest revision of F-GAS, entered into force in 2015, set up a phase down program for traditional HFC's refrigerants. In 2018 first significant reduction step will be introduced (37%) and in 2030 the reduction (calculated in equivalent CO2 tons) will need to achieve almost 80%.

HFC's phase down objectives\*:

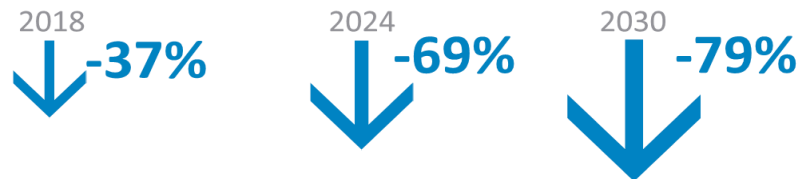

(\* Baseline value (100%) is the annual average of total quantity of CO2 equivalents placed on EU Market from 2009 to 2012

The new Daikin *BLUEEVOLUTION* chillers uses R-32 refrigerant to reduce drastically the carbon footprint of the unit. The selection of R-32 (chemical name difluoromethane) minimises the global warming impact of scroll compressor chillers thanks to the lower Global Warming Potential in combination with high-energy efficiency. The Global Warming Potential of R-32 is 675, which is only one third of the commonly used refrigerant R-410A.

Thanks to the lower flammability classification (R-32 refrigerant is classified A2L in ISO817), it can be safely used in many applications including chilled water systems. Being a single component refrigerant, R-32 is also easier to recycle and reuse, that is another environmental plus in its favour.

Daikin has a long history of continuous reduction of the environmental impact of cooling, heating and refrigeration, having a unique expertise that comes from manufacturing both refrigerants and equipment. This position is one of the results of company's corporate philosophy to "Be a Company that Leads in Applying Environmentally Friendly Practices".

Regarding refrigerant choice, Daikin has expertise in using fluorinated (HFC, HFO) as well as non-fluorinated gases (ammonia, carbon dioxide, hydrocarbons), because the company believes in diversity of refrigerant choice to allow the best suited solution to be used in each application.

**Range overview.**



EWAT-B- is available with:

- 2 different layouts: Single-V coil and Modular-V coils.
- 2 Efficiency levels: Gold (high efficiency) and Silver (standard efficiency).
- One or Two independent refrigerant circuits.

**BLUEEVOLUTION**

Single Circuit	Silver Efficiency	81-217 kW	238-341 kW	
	Gold efficiency	81-183 kW	238-350 kW	
Twin Circuit	Silver Efficiency	158-212 kW	240-663 kW	
	Gold Efficiency		178-701 kW	

- 3 noise versions: Standard, Low and Reduced each one carefully designed to meet the acoustic requirements of the installation site.

Layout	SINGLE V 			MODULAR V 		
Sound Version	Compressor Acoustic enclosure	Fan speed	Avg sound power reduction	Compressor Acoustic enclosure	Fan speed	Avg sound power reduction
Standard	Not insulated	Standard	-	-	Standard	-
Low	Insulated	Standard	-1,5dB(A)	Insulated	Standard	-3,0dB(A)
Reduced	Insulated	Reduced	-6,5dB(A)	Insulated	Reduced	-8,5dB(A)

**Outstanding reliability.**

The chillers have one or two truly independent refrigerant circuits with two or three compressors, to assure maximum safety for any maintenance, whether planned or not.

**Condensation control.**

Single-V units are standardly equipped with continuous fan speed modulation (phase cut) to ensure precise airflow control and optimized condensing temperature. Modular-V units are equipped with fan speed modulation (VFD) on request (standard on reduced noise units).

**Fan silent mode.**

Units equipped with fan modulation are standardly supplied with fan silent mode. This feature allows the user to set up detailed time bands to reduced fan rotation speed and therefore sound emission in those areas where night quietness is a mandatory requirement (approximately -4dB(A) – detailed values are available on CSS selection software)

**Superior control logic.**

The MicroTech 4 controller provides an easy to use control environment. The control logic is designed to provide maximum efficiency, to continue operation in unusual operating conditions and to provide history of unit operation. Easy interface with LonWorks, Bacnet, Ethernet TCP/IP or Modbus communications. Master/Slave operation is provided as standard allowing to connect up to 4 units working as single system.

**Dynamic Condensing Pressure Management.**

Superior software logic has been developed to get the highest efficiency at whichever operating condition: thanks to the Dynamic Condensing Pressure Management the chiller controller adjusts the condensing pressure set-point to minimize the overall chiller power input.

**Code requirements – Safety and observant of laws/directives**

Units are designed and manufactured in accordance to the following directives and harmonized standards:

Low voltage directive	DIRECTIVE 2014/35/EU
Electromagnetic compatibility (EMC)	DIRECTIVE 2014/30/EU
Machinery directive	DIRECTIVE 2006/42/EC
Pressure equipment desing	DIRECTIVE 2014/68/EU
Ecodesing	DIRECTIVE 2009/125/EC
Safety of machinery	EN 60204-1
EMC - Part 6-2	EN 61000-6-2
EMC - Part 6-4	EN 61000-6-4
Safety and environmental requirements	EN 378-1; EN 378-2; EN 378-4
Methods for calculation pressure relief devices.	EN 13136

**Certifications.**

Units are CE marked, complying with European directives in force, concerning manufacturing and safety. On request units can be produced complying with laws in force in non-European countries (ASME, etc.), and with other applications.

**Compressors**

Hermetic orbiting scroll type optimized for R-32 operation and complete with motor over-temperature and over-current protection devices. Each compressor is equipped with an oil heater that keeps the oil from being diluted by the refrigerant when the chiller is not running. The compressors are connected in Tandem or Trio configuration on each refrigerant circuit. Each compressor is mounted on rubber antivibration mounts for a quiet operation. Unit is delivered with complete oil charge.

**Evaporator**

The unit is equipped with a direct expansion plate-to-plate type evaporator optimized for R-32 refrigerant operation. This heat exchanger is made of stainless-steel brazed plates and is covered with 10mm closed cell insulation material. The exchanger is equipped with an electric heater for protection against freezing and evaporator water connections are provided with victaulic kit (as standard). The evaporator is manufactured in accordance to 2014/68/EU. The evaporator flow switch and the evaporator water filter are available as option. Note the installation of an evaporator flow switch and an evaporator water filter is mandatory.

**Condenser**

The condenser is made entirely of aluminum and it is optimized for R-32 refrigerant operation. Full-depth louvered aluminum fins are inserted between the aluminum tubes maximizing the heat exchange.

The Microchannel technology ensures the highest performance with the minimum surface for the exchanger. This technology reduces unit refrigerant charge compared to traditional copper tubes and aluminum condenser.

Special treatment ensure resistance to the corrosion by atmospheric agents extending the lifetime.

Note: applications in industrial, costal, highly polluted urban environment or combinations of them, require proper evaluation to understand if additional measures are needed to protect the condenser coil from the aggressive environment.

**Condenser fans**

Condenser fans are propeller type with high efficiency design blades to maximize performances. The blades are made of glass-reinforced resin and a guard protects each fan.

Single-V units are equipped as standard with fan speed modulation (phase cut).

Modular-V units (standard and low sound versions) are equipped with on/off fans and inverter drive is available as an option. Modular-V units reduced noise versions are equipped with inverter driven fans as standard.

**Electronic expansion valve**

The unit is equipped with electronic expansion valves to achieve precise control of R-32 refrigerant mass flow. As today's systems require improved energy efficiency, accurate temperature control, wide range of operating conditions, the application of electronic expansion valves becomes mandatory.

Electronic expansion valves has unique features: short opening and closing time, high resolution, positive shut-off function to eliminate use of additional solenoid valve, continuous modulation of mass flow without stress in the refrigerant circuit and corrosion resistance stainless steel body.

If compared to traditional thermostatic valves, electronic expansion valves allow the system to work with low condenser pressure (winter time) without any refrigerant flow problems and the perfect control of the chilled water temperature.

**Refrigerant circuit**

Each unit has one or two independent refrigerant circuits and each one includes:

- Compressor
- Refrigerant
- Evaporator
- Air Cooled Condenser
- Electronic expansion valve
- Sight glass with moisture indicator
- Filter drier
- Charging valves
- High pressure switch
- High pressure transducers
- Low pressure transducers
- Oil pressure transducer
- Suction temperature sensor

**Electrical panel**

Power and control are in the main panel that is manufactured to ensure protection against all weather conditions. The electrical panel is IP54 and (when opening the doors) internally protected against possible accidental contact with live parts. The main panel is fitted with a main switch interlocked door that shuts off power supply when opening.

**MicroTech 4 controller**

The new MicroTech 4 controller is installed as standard in all Daikin units.

It gives the possibility to check the most relevant control parameters and modify unit set-points. A built-in display shows unit operating status. Additionally, temperatures and pressures of water, refrigerant and air, programmable values, set-points can be accessed based on a preset list of user profiles.

A sophisticated software with adaptive logic, selects the most energy efficient combination of compressors, EEXV and fans to keep stable operating conditions to maximize unit energy efficiency and reliability.

MicroTech 4 protects critical components based on external signals from onboard sub-system (such as motor temperatures, refrigerant and oil pressures and temperatures, correctness of phase sequence, pressure switches and freezing of heat exchanger).

The input coming from high-pressure switches cuts all digital output from the controller in less than 50ms, as an additional security for the equipment. Fast program cycle (less than 200ms) for a precise monitoring of the system and sub-systems.

Floating point calculations supported for increased accuracy in Pressure / Temperature conversions.

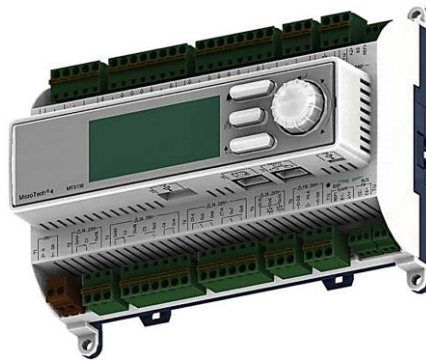

Comparing to the Microtech III, the new MicroTech IV is faster and has more memory. Both features are key to support all the new functions (integration of Master/Slave and iCM, Energy Monitoring, etc.)

Subject	MicroTech III	MicroTech 4	Benefit
Micro-processor	72 MHz	204MHz	Faster calculation capabilities
Memory	8MB Flash and 16MB SDRAM	64MB Flash and 64MB SDRAM	Faster calculation capabilities
Application	1MB	3MB	More advanced functions
Boot Time	30 seconds	10 seconds	Faster re-start time

**Control main features**

Control system has the following features:

- Management of compressors and fans modulation;
- Control of cooling or heating leaving water temperatures;
- Management of cooling and heating capacities according to the load;
- Switch of operating modes in less than 1 minute;
- Return reset (set point reset based on return water temperature);
- Set point reset (optional);
- Unit operation in partial failure condition;
- Managed operations during critical conditions:
  - High ambient temperature;
  - High thermal load;
  - Startup with high and low differential operating conditions;
  - Startup with high entering water temperature in cooling mode;
  - Startup with low entering water temperature in heating mode;

- Optimized management of compressor load;
  - Optimized fan management according to condensing pressure;
  - General faults alarm relay;
  - Automatic re-start in case of power failure;
  - Rapid Restart to recover full load in the shortest possible time for Data Centre application;
  - ICM Standard control for multiple units management (optional);
  - Soft load (optimized management of the compressor load during the start-up);
  - Start at high cold heat exchanger water temperature;
- 
- Visualization of:
    - cooling and heating entering/leaving water temperature of heat exchangers;
    - outdoor ambient temperature;
    - condensing-evaporating temperature and pressure, suction and discharge superheat for each circuit;
    - hours and starts counter for compressors and pumps;
    - status safety devices;

### **Control additional features**

- System upgrade with commercial SD cards;
- Save/Restore of configuration parameters with a commercial SD card;
- Ethernet port for remote or local servicing using standard web browsers;
- Daikin on Site connectivity for cloud based

### **Safety device / logic for each refrigerant circuit**

The following devices / logics are available:

- high pressure (pressure switch);
- high pressure (transducer);
- low pressure (transducer);
- fans circuit breakers;
- high compressor discharge temperature;
- high motor winding temperature;
- phase monitor;
- low pressure ratio;
- high oil pressure drops;
- low oil pressure;
- no pressure changes at start.

### **System security**

The following securities are available:

- phase monitor;
- low ambient temperature lock-out;
- freeze protection.

### **Regulation type**

Proportional integral derivative regulation on the cold heat exchanger leaving water output probe.

### **MicroTech 4**

MicroTech 4 built-in terminal has the following features:

- Liquid crystal display with white back lighting, supports Unicode fonts for multi-lingual;
- Key-pad consisting of 3 keys;
- Push'n'roll control for an increased usability;
- Flash memory to protect the data;
- Password access to modify the setting;
- Application security to prevent application tampering or hardware usability with third party applications;
- Alarm history memory to allow an easy fault analysis.

### **Supervising systems MicroTech 4 remote communication (on request)**

MicroTech 4 can communicate to BMS (Building Management System) based on the most common protocols as:

- ModbusRTU (Native);
- LonWorks,
- BACnet BTP certified over IP and MS/TP (class 4) (Native);
- Ethernet TCP/IP (Native).

**Additional information related to F-GAS Regulation (EU) No 517/2014 of the European Parliament and of the Council of 16 April 2014 on fluorinated greenhouse gases and repealing Regulation (EC) No 842/2006**

Unit Model	Refrigerant type	Refrigerant GWP	N° of circuits	Refrigerant charge Circuit 1 [kg]	Refrigerant charge Circuit 2 [kg]
EWAT085B-SS(L)(R)B1	R32	675	1	7.5	-
EWAT115B-SS(L)(R)B1	R32	675	1	8.5	-
EWAT135B-SS(L)(R)B1	R32	675	1	8.5	-
EWAT175B-SS(L)(R)B1	R32	675	1	11.0	-
EWAT215B-SS(L)(R)B1	R32	675	1	13.0	-
EWAT290B-SS(L)(R)B1	R32	675	1	19.0	-
EWAT340B-SS(L)(R)B1	R32	675	1	26.0	-
EWAT155B-SS(L)(R)B2	R32	675	2	6.5	6.5
EWAT195B-SS(L)(R)B2	R32	675	2	7.2	7.3
EWAT205B-SS(L)(R)B2	R32	675	2	7.3	7.3
EWAT240B-SS(L)(R)B2	R32	675	2	9.8	9.2
EWAT260B-SS(L)(R)B2	R32	675	2	10.0	9.0
EWAT310B-SS(L)(R)B2	R32	675	2	11.5	14.0
EWAT330B-SS(L)(R)B2	R32	675	2	11.5	13.5
EWAT350B-SS(L)(R)B2	R32	675	2	10.5	13.5
EWAT420B-SS(L)(R)B2	R32	675	2	16.4	18.1
EWAT460B-SS(L)(R)B2	R32	675	2	15.8	20.2
EWAT510B-SS(L)(R)B2	R32	675	2	20.0	21.0
EWAT570B-SS(L)(R)B2	R32	675	2	21.0	21.0
EWAT610B-SS(L)(R)B2	R32	675	2	22.0	24.5
EWAT670B-SS(L)(R)B2	R32	675	2	25.5	27.0

Unit Model	Refrigerant type	Refrigerant GWP	N° of circuits	Refrigerant charge Circuit 1 [kg]	Refrigerant charge Circuit 2 [kg]
EWAT085B-XS(L)(R)B1	R32	675	1	9.0	-
EWAT115B-XS(L)(R)B1	R32	675	1	10.0	-
EWAT145B-XS(L)(R)B1	R32	675	1	11.0	-
EWAT185B-XS(L)(R)B1	R32	675	1	12.0	-
EWAT230B-XS(L)(R)B1	R32	675	1	23.5	-
EWAT300B-XS(L)(R)B1	R32	675	1	28.0	-
EWAT360B-XS(L)(R)B1	R32	675	1	32.0	-
EWAT180B-XS(L)(R)B2	R32	675	2	10.0	10.0
EWAT200B-XS(L)(R)B2	R32	675	2	10.3	9.7
EWAT220B-XS(L)(R)B2	R32	675	2	10.2	9.8
EWAT250B-XS(L)(R)B2	R32	675	2	11.0	13.0
EWAT280B-XS(L)(R)B2	R32	675	2	11.5	16.0
EWAT310B-XS(L)(R)B2	R32	675	2	11.5	16.5
EWAT320B-XS(L)(R)B2	R32	675	2	11.0	16.5
EWAT370B-XS(L)(R)B2	R32	675	2	14.0	17.0
EWAT430B-XS(L)(R)B2	R32	675	2	18.5	17.5
EWAT470B-XS(L)(R)B2	R32	675	2	20.5	23.0
EWAT540B-XS(L)(R)B2	R32	675	2	22.0	27.0
EWAT600B-XS(L)(R)B2	R32	675	2	27.0	28.0
EWAT660B-XS(L)(R)B2	R32	675	2	29.0	31.0
EWAT700B-XS(L)(R)B2	R32	675	2	31.0	35.0

Note: Equipment contains fluorinated greenhouse gases.

**Actual refrigerant charge depends on the final unit construction, details can be found on the unit labels.**

## Nomenclature

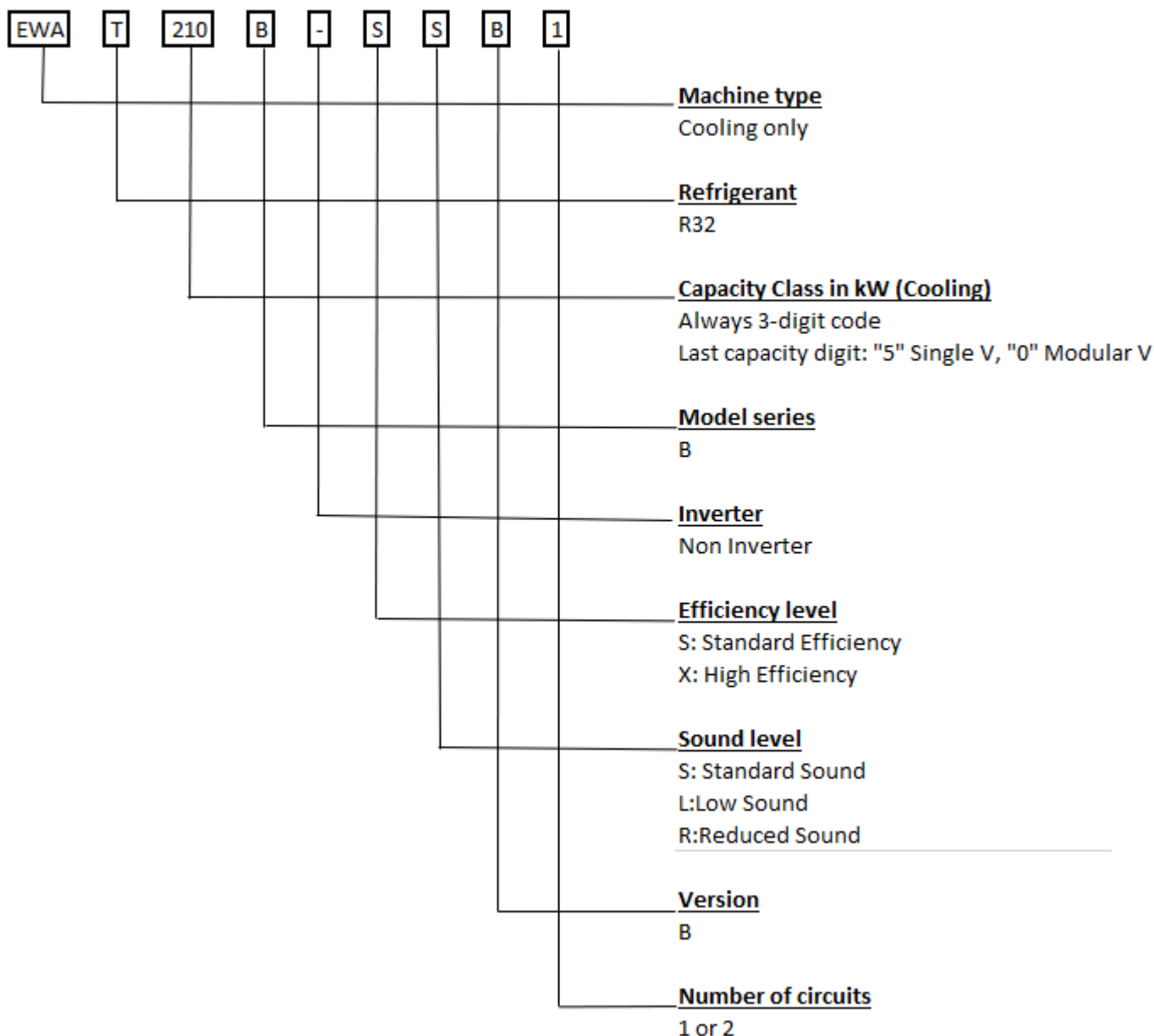

## Standard Options (supplied on basic units)

### Double set point (OP. code 10 – provided as standard)

Possibility to pre-set two different chilled water temperature set points (cooling mode).

### Evaporator Victaulic KIT (OP. code 20 – provided as standard) - OP. incompatibility 21

It includes the victaulic joint and the counter pipe fitted with victaulic groove to be welded with the plant pipes -

### Evaporator electric heater (OP. code 57 – provided as standard)

### Electronic expansion valve (OP. code 60 – provided as standard)

**Ambient outside temperature sensor and set-point reset (OP. code 67 – provided as standard)** Setpoint Reset: The leaving water temperature set-point can be overwritten through an external 4- 20mA signal, through the ambient temperature, or through the evaporator water temperature  $\Delta T$ .

### Hour run meter (OP. code 68 – provided as standard)

### General fault contactor (OP. code 69 – provided as standard)

### Main switch interlock door (OP. code 97 – provided as standard)



**Master / Slave (OP. code 128 – provided as standard)**

The EWAT~B features the new DAIKIN Master/ Slave (M/S) control. Once set which unit has the role of master, the other(s) will operate as slave(s) based on the inputs provided by the master. The chillers must be installed in parallel in the hydronic plant.

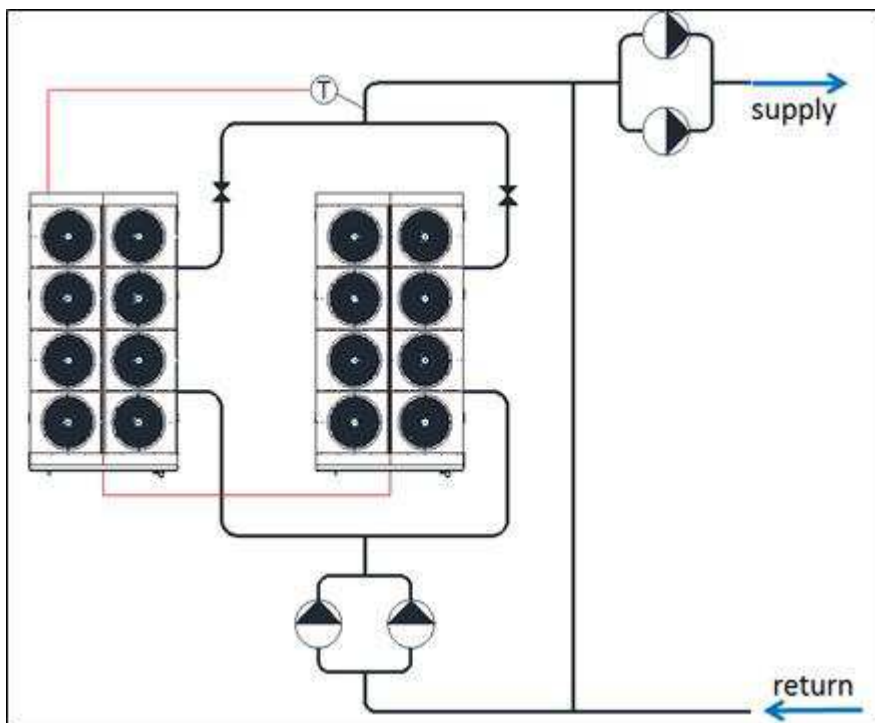

With Master/Slave control is possible to balance the working hours of the compressors enhancing reliability and extending the life of the system.

In order to operate in Master/Slave mode an additional probe (PT1000 or NTC10K) must be installed on the common line of the plant and connected to the master unit. The additional probe is not provided by the factory. Master/Slave can manage units selected with pump on board (fix speed pumps). Note: check valves must be installed at the outlet of each chiller.

Master/Slave can also manage the start and stop of external pumps (not provided by factory). In this case, the power supply of external pumps is not provided by the unit.

**Mechanical Options – On request**

**20mm evaporator insulation (OP. code 29)**

The heat exchanger is fitted with 20mm closed cell insulation material - *OP. incompatibility 08.*

**Discharge line shut-off valve (OP. code 61– Modular-V units only) OP. incompatibility 171\*-172\*-173\***

Installed on the common discharge pipe of the compressors to facilitate maintenance operation (one discharge valve per refrigerant circuit).

**Suction line shut-off valve (OP. code 62– Modular-V units only) OP. incompatibility 171\***

Installed on the common suction pipe of the compressors to facilitate maintenance operation (one suction valve per refrigerant circuit).

**Discharge and Suction line shut-off valve (OP. code 126– Single-V units only)**

*OP. incompatibility 171-172-173*

Installed on the common suction discharge and suction pipes of the compressors to facilitate maintenance operation (one discharge and one suction valve per refrigerant circuit).

**Alarm from external device (OP. code 70)**

The unit controller is able to receive an external alarm signal. The user can decide whether this alarm signal will stop the unit or not.

**Fans circuit breakers (OP. code 96) OP. incompatibility 171-172-173-99a**

Safety devices that, added to the standard protection ones, protect fan motors against overload and overcurrent.

**Water filter (OP. code 115)**

The water filter removes impurities from water by means of a fine physical barrier. It must be installed on the water pipe connected to the heat exchanger inlet.

The filter is shipped loose together with two victaulic joints and two counter pipes to be welded on the plants.

NOTE: The installation of the filter is mandatory.

**Total Heat Recovery (OP. code 01)** - OP. incompatibility 03A, 171, 172, 173, 134, 135, 136, 137, 120e, 120f, 120g, 120h, 120E-FC, 120F-FC, 120G-FC, 120H-FC. Not available on the following models: EWAT085B-SSB1, EWAT085B-SLB1, and EWAT085B-SRB1.

A plate to plate heat exchanger for each refrigerant circuit is installed in series to the condenser coil. There is no switch nor solenoid valve in the circuit, thus compressor discharged refrigerant is always flowing through the heat recovery exchanger and hot water production is always available while the chiller is providing cooling. During the operation in heat recover the condenser coils provides the sub-cooling ensuring the right amount of liquid at the inlet of the expansion valve. The unit controller manages the condensing temperature set point in order to maximize the cooling effect and amount of energy recovered.

The amount of heat recovered is about the **80/85%** (according to the operating conditions) of the total heat rejection of the chiller. The chiller performs the control on the recovery circuit, based on the return water temperature to the unit. Heat recovery capability is subject to cooling load demand (if no cooling demand is present then no heat recovery is available)

**Partial Heat Recovery (OP. code 03A)** - OP. incompatibility 01, 171, 172, 173, 134, 135, 136, 137, 120e, 120f, 120g, 120h, 120E-FC, 120F-FC, 120G-FC, 120H-FC. Not available on the following models: EWAT085B-SSB1, EWAT085B-SLB1, and EWAT085B-SRB1.

A plate to plate heat exchanger for each refrigerant circuit is installed in series to the condenser coil. There is no switch nor solenoid valve in the circuit, thus compressor discharged refrigerant is always flowing through the heat recovery exchanger and hot water production is always available while the chiller is providing cooling. During the operation in heat recover the condenser coils provides the sub-cooling ensuring the right amount of liquid at the inlet of the expansion valve. The unit controller manages the condensing temperature set point in order to maximize the cooling effect and amount of energy recovered.

The amount of heat recovered is about the **15/20%** (according to the operating conditions) of the total heat rejection of the chiller. The chiller performs the control on the recovery circuit, based on the return water temperature to the unit. Heat recovery capability is subject to cooling load demand (if no cooling demand is present then no heat recovery is available)

**Brine Version (OP. code 08)** - OP. incompatibility 29

For operation with temperature at the outlet of the evaporator below +4°C the unit must operate with glycol mixture (with ethylene or propylene glycol) and the Brine Version option must be selected. Brine version includes additional insulation on evaporator surfaces.



**Evaporator flange kit (opt. code 21)** Opt. incompatibility 20

In case of opt.21 selected, Victaulic connections are still provided. The installation of any Water Filter (to be carried out by the installer) is as follows in the example;

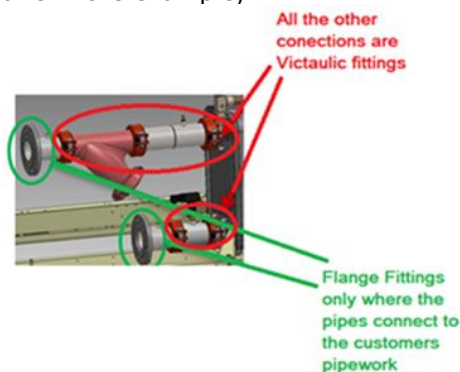

**High pressure side manometers (OP. code 63 – Modular-V units only)**

**Low pressure side manometers (OP. code 64 – Modular-V units only)**

**High and Low pressure side manometers (OP. code 127 – Single-V units only)** OP. incompatibility 171-172-173

**Double pressure relief valve with diverter (OP. code 91)**

**Hydronic kits:**

- **One centrifugal pump (Low lift) (OP. code 78)**
- **One centrifugal pump (high lift) (OP. code 79)**
- **Two centrifugal pump (Low lift) (OP. code 80)**
- **Two centrifugal pump (high lift) (OP. code 81)**
- **One centrifugal pump (Low lift) + water tank (OP. code 134)**
- **One centrifugal pump (high lift) + water tank (OP. code 135)**
- **Two centrifugal pump (Low lift) + water tank (OP. code 136)**
- **Two centrifugal pump (high lift) + water tank (OP. code 137)**

Unit mounted hydronic kits are available with single and dual pumps.

The Low lift kits provides an average available head of 100 kPa at chiller standard conditions. The High lift kits provides an average available head of 200 kPa at chiller standard conditions.

The kit is completed with pressure gauge, safety valve, drain valve. The motor pump is protected by a circuit breaker installed in control panel. Pump motors are insulation class F, IP55 protected and supplied by the unit with 400V/3ph/50Hz electric current. The kit is assembled and wired to the control panel. The pipe and pump are protected from freezing with an additional electrical heater; on Modular V units, electrical heater is always present with/without tank, for the Single V units only if tank onboard is selected (refer to the water side P&I).

In case of unit equipped with hydronic kit on board selected to operate with glycol mixture, contact factory.

Water buffer tank volume (if selected), depends on unit model size – detailed informations available on section “Options (technical data)” of this databook. For incompatibility refer to the table below:

Option	Description	Incompatibility
78	ONE CENTRIFUGAL PUMP (LOW LIFT)	172,173,79,80,81,134,135,136,137
79	ONE CENTRIFUGAL PUMP (HIGH LIFT)	172,173,78,80,81,134,135,136,137
80	TWO CENTRIFUGAL PUMP (LOW LIFT)	172,173,78,79,81,134,135,136,137
81	TWO CENTRIFUGAL PUMP (HIGH LIFT)	172,173,78,79,80,134,135,136,137
134	ONE CENTRIFUGAL PUMP (LOW LIFT) + TANK	171,172,173,01,03A,78,79,80,81,135,136,137,120e,120f,120g,120h,120E-FC,120F-FC,120G-FC,120H-FC
135	ONE CENTRIFUGAL PUMP (HIGH LIFT) + TANK	171,172,173,01,03A,78,79,80,81,134,136,137,120e,120f,120g,120h,120E-FC,120F-FC,120G-FC,120H-FC
136	TWO CENTRIFUGAL PUMP (LOW LIFT) + TANK	171,172,173,01,03A,78,79,80,81,134,135,137,120e,120f,120g,120h,120E-FC,120F-FC,120G-FC,120H-FC
137	TWO CENTRIFUGAL PUMP (HIGH LIFT) + TANK	171,172,173,01,03A,78,79,80,81,134,135,136,120e,120f,120g,120h,120E-FC,120F-FC,120G-FC,120H-FC

**Refrigerant leak detection (OP. code 121 - Available only on units with compressors’ enclosure)**

Automated permanent refrigerant leak detection system installed on board. The refrigerant sensors are installed within the compressor enclosures and are specifically calibrated for R-32 refrigerant. When leaks above a certain concentration are detected, the sensor provides a signal to the unit controller (a specific alarm is visualized on the unit microprocessor). The automatic shut down and pump down of refrigerant into the condensing section occurs on the detection of refrigerant leakage. The alarm threshold that triggers automatic pump down upon detection of refrigerant is set to a maximum of 500ppm. Available only on units with compressors’ enclosure.

**E-coating microchannel coils (OP. code 139) - OP. incompatibility 153**

A protection a layer of an epoxy polymer is added on the surface of the exchanger. The process consists in the complete immersion of the exchanger in the epoxy polymer solution. An electric voltage applied to the exchanger causes a difference with the electrical charge of the polymer molecules that, as result, are drawn to the metal. The thickness of the coating is controlled by the applied voltage. The result is a uniform layer of epoxy polymers applied all over the exchanger surface. A final UV top-coat treatment is applied on the coil surface. The treatment is recommended in all application where high risk of corrosion exist (eg: high polluted urban, costal, industrial environments and their combinations).

**Unit guards (to cover unit access) (OP. code 140) OP. incompatibility 172-173**

Wire mesh that cover the access around the unit.

**Side panels on coil ends (OP. code 141 – Modular-V units only)**

Protection panel on both side of each condensing module.

**Blue coat (OP. code 153 – Modular-V units only) - OP. incompatibility 139**

An epoxy powder is sprayed and electrostatically fixed to the coil. Once the surface is completely covered by the epoxy material, the coil is sent into a furnace for the drying and curing phase. The result is a uniform and durable coating that enhance the resistance to the corrosion. The treatment is recommended in all application where moderate risk of corrosion exist (eg: urban, costal, industrial environments)

## Electrical options – On request

**Compressor thermal overload relays (OP. code 11 – Modular-V units only)** - *OP. incompatibility 95*  
Available on Modular-V units only.

**Under over voltage control (OP. code 15)**

Electronic device that monitors and displays input voltage. It stops the chiller in case of phase loss, wrong phase sequence, or voltage exceeding minimum and maximum allowed values.

**Energy meter (OP. code 16)**

Device installed inside the control box that displays chillers’ electrical power parameters such as input line voltage and phase current, input active and reactive power, active and reactive energy. An integrated RS485 module allows a Modbus communication to an external BMS.

**Speedtrol (OP. code 42 – Modular-V units only)** - *OP. incompatibility 99-99a-142a-160-161-171-172-173-142B-142C*

Continuous fan speed regulation on the first fan (VFD driven) of each circuit. It allows unit operation down to -18°C (available for standard and low sound version).

**Evaporator flow switch (OP. code 58)**

On Modular V units, it is supplied separately to be wired and installed on the evaporator water piping (by the customer). On Single V units, it is mounted and cabled. The installation of the flow switch is mandatory.

**Compressors circuit breakers (OP. code 95)** - *OP. incompatibility 11*

Safety devices that include in a single device all safety functions otherwise provided by standard fuses and optional thermal relays, such as protection against overcurrent, overload, current unbalance.

**Fans speed regulation (OP. code 99 and 99a)**

Fans speed regulation: continuous modulation of the fans’ speed for optimal condensation control at low ambient temperatures.

Fans silent mode: This feature allows the user to set up customized time bands to reduced fans’ speed rotation and therefore sound emission in those areas where quiet is a mandatory requirement during specific time of the day (e.g. night operation).

Note: option 99 is standard on Single V units (phase cut).

Note: option 99a is standard on Modular-V units reduced sound (inverter).

**Ground fault relay (OP. code 102 – Modular-V units only)**

To shut down the unit in case of a ground fault condition is detected.

**Inverter kit for pumps:**

- **INVERTER KIT FOR 1 CENTR PUMP LOW LIFT (OP. code 120e)**
- **INVERTER KIT FOR 1 CENTR PUMP HIGH LIFT (OP. code 120f)**
- **INVERTER KIT FOR 2 CENTR PUMP LOW LIFT (OP. code 120g)**
- **INVERTER KIT FOR 2 CENTR PUMP HIGH LIFT (OP. code 120h)**
- **INVERTER KIT FOR 1 CENTR PUMP LOW LIFT (FC) (OP. code 120E-FC)**
- **INVERTER KIT FOR 1 CENTR PUMP HIGH LIFT (FC) (OP. code 120F-FC)**
- **INVERTER KIT FOR 2 CENTR PUMP LOW LIFT (FC) (OP. code 120G-FC)**
- **INVERTER KIT FOR 2 CENTR PUMP HIGH LIFT (FC) (OP. code 120H-FC)**

the Inverter kit must be associated with the corresponding hydronic kit (OP. code 78/79/80/81). It is standardly not compatible with kit pump + water tank. Contact factory to evaluate feasibility.

For incompatibility refer to the table below:

Option	Description	Incompatibility
120e	INVERTER KIT FOR 1 CENTR PUMP LOW LIFT	171, 172, 173, 01, 03A, 134, 135, 136, 137, 120f, 120g, 120h, 120E-FC, 120F-FC, 120G-FC, 120H-FC, 79, 80, 81
120f	INVERTER KIT FOR 1 CENTR PUMP HIGH LIFT	171, 172, 173, 01, 03A, 134, 135, 136, 137, 120e, 120g, 120h, 120E-FC, 120F-FC, 120G-FC, 120H-FC, 78, 80, 81
120g	INVERTER KIT FOR 2 CENTR PUMP LOW LIFT	171, 172, 173, 01, 03A, 134, 135, 136, 137, 120e, 120f, 120h, 120E-FC, 120F-FC, 120G-FC, 120H-FC, 78, 79, 81
120h	INVERTER KIT FOR 2 CENTR PUMP HIGH LIFT	171, 172, 173, 01, 03A, 134, 135, 136, 137, 120e, 120f, 120g, 120E-FC, 120F-FC, 120G-FC, 120H-FC, 78, 79, 80
120E-FC	INVERTER KIT FOR 1 CENTR PUMP LOW LIFT (FC)	172, 173, 01, 03A, 134, 135, 136, 137, 120e, 120f, 120g, 120h, 120F-FC, 120G-FC, 120H-FC, 79, 80, 81
120F-FC	INVERTER KIT FOR 1 CENTR PUMP HIGH LIFT (FC)	172, 173, 01, 03A, 134, 135, 136, 137, 120e, 120f, 120g, 120h, 120E-FC, 120G-FC, 120H-FC, 78, 80, 81
120G-FC	INVERTER KIT FOR 2 CENTR PUMP LOW LIFT (FC)	172, 173, 01, 03A, 134, 135, 136, 137, 120e, 120f, 120g, 120h, 120E-FC, 120F-FC, 120H-FC, 78, 79, 81
120H-FC	INVERTER KIT FOR 2 CENTR PUMP HIGH LIFT (FC)	172, 173, 01, 03A, 134, 135, 136, 137, 120e, 120f, 120g, 120h, 120E-FC, 120F-FC, 120G-FC, 78, 79, 80

The inverter kit can be used for the following purposes:

- **Adjusting the water flow rate during unit commissioning.**

- **Control the pump speed via external input from Building Management System (BMS)**

For this application a 0-10V signal for the pump speed must be provided from the plant manager according to the specific control strategy of the plant. The water must be within the minimum and maximum value allowed for the unit (refer to the "Operating limit" chapter). The change in water flow rate must not be exceed more than 10% of the design water flow rate per minute.

- **Set a "thermostat off" pump speed.** Providing the unit with the inverter kit for the on-board pump is possible to manage two different water flow settings. A setting for water flow during the "Thermostat ON" mode (when the chiller is actually providing cooling to the plant), and a set for the "thermostat off" mode (when the plant load is satisfied and the compressors are waiting to start). This feature allows to achieve energy saving on plant operating cost by reducing the speed of the pumps when the chiller has reached the set point.

Thanks to the saving on pumping cost, the payback time for the Inverter Kit is approximately one year.

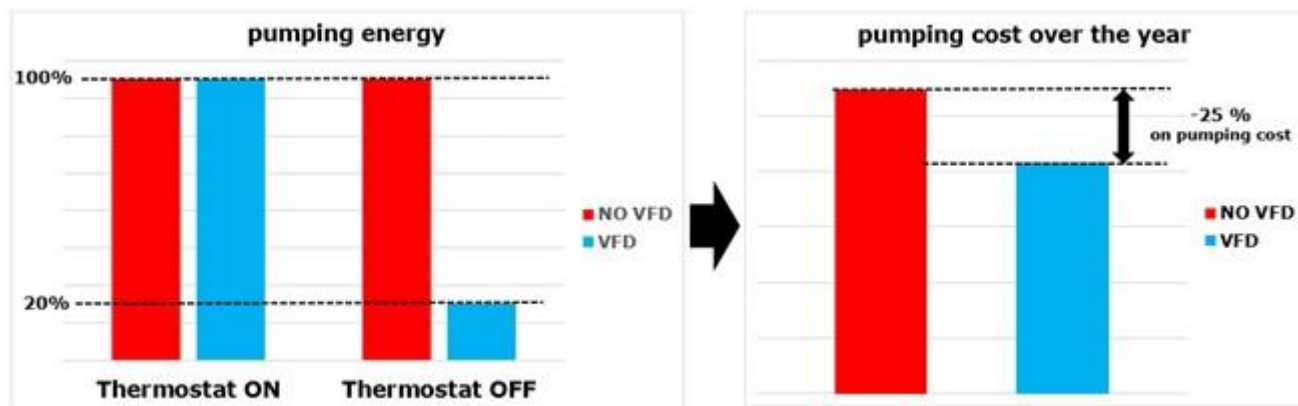

**Max Ambient temperature for a proper working of the Inverters is 40°C.**

**Control variable flow on primary loop based on chiller delta-T** (available as standard for single chiller installation only)

Providing the unit with the inverter kit for the on-board pump it is possible to manage a variable water flow rate for the primary loop. This function is available as standard when the hydronic kit plus inverter are selected.

The standard feature is applicable for single unit installation only. In case of multiple chillers installation an additional control is needed.

The variable flow control is suitable for primary/secondary plant, cannot be used in primary plant only.

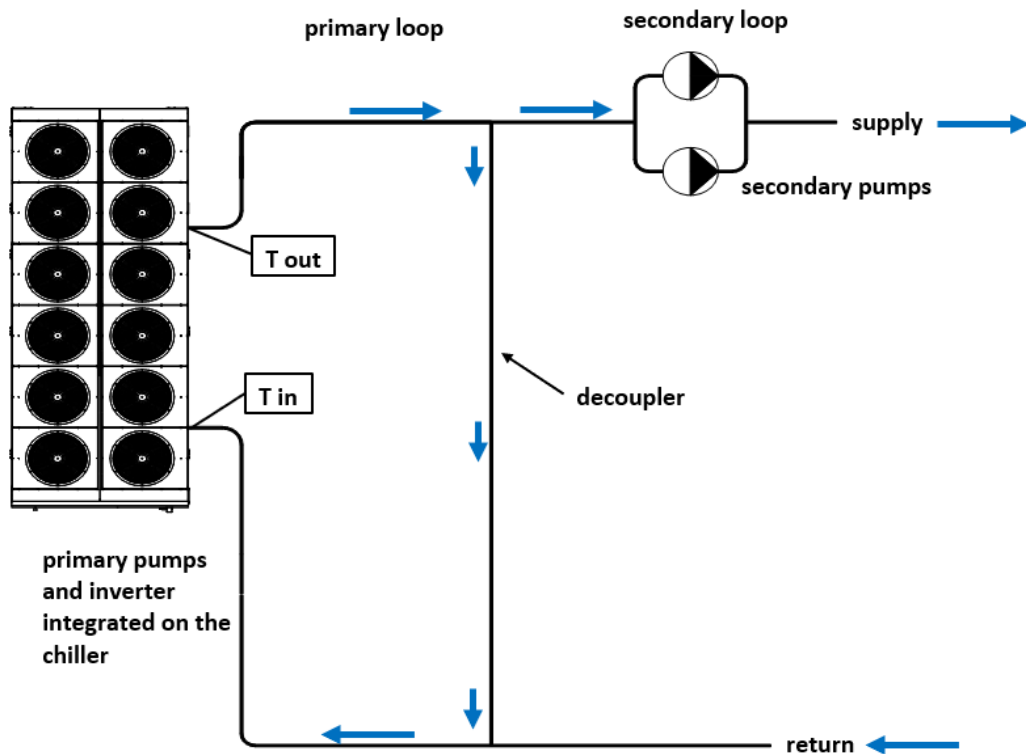

In a Primary-Secondary plant configuration a key component is the decoupler. The decoupler is always open (no valve must be installed). The aim of the decoupler is to allow the primary and secondary pumps to operate at different flow rates. This is necessary because the primary pumps and secondary pumps are managed differently and so the primary and secondary flow rates are practically never the same. Specifically, the primary flow rate is managed based on the chiller delta-T ( $T_{out} - T_{in}$ ), the secondary flow rate is regulated to maintain the necessary pressure differential in the secondary loop. The direction of the water flow through the decoupler must be always from supply to return. To ensure this the primary flow rate must be greater than the secondary flow rate. If this condition is not respected the warmer return water will flow backwards through the decoupler and raise the supply water temperature. Due to the higher temperature of the supply water temperature the terminal unit control will open the valves asking for higher water flow rate. The secondary pumps will speed up increasing even more the water flow rate on secondary plant making the situation even worse (secondary flow rate  $\gg$  primary flow rate). As a result there will be no control on the supply water temperature losing effectiveness of the cooling plant.

On the other side any excess in the primary flow, vs. secondary flow, flows through the decoupler from the supply to the return mixing with the warmer return water. To reach this target it is very important to have a minimum pressure drop in the decoupler that needs to be sized to reach a pressure drop that should not exceed 4-5 kPa at the minimum for the flow rate of the primary pump.

Activating the variable flow control the chiller will modulate the water flow rate based on the chiller delta-T.

When the secondary loop will reduce the water flow rate (because the plant load decreases), the water flow rate in the decoupler (always from supply to return) increases. The return water temperature mixes with the supply water from the decoupler reducing the water temperature at the inlet temperature and so the delta-T on the chiller. As a consequence the chiller control reduces the speed of the pump, reducing the primary flow rate.

On the opposite, when the flow rate on secondary flow increases also the water temperature at the chiller inlet increases (increasing the delta-T); therefore, the chiller control will increase the water flow rate.

### **Variable Primary Flow (OP. code 143) OP. incompatibility 172-173**

By selecting OP. 143 the chiller can manage the Variable Primary water flow according to the differential pressure measured in a specific point of the plant, selected by the plant designer. The differential pressure transducer is available as an option from the factory (OP. code 144). Once installed, the differential pressure transducer must be connected to the unit. As an alternative the unit controller can receive directly the differential pressure value from an external BMS communicating with the standards communication protocols (eg. MODBUS).

The Variable Primary Flow (VPF) configuration is an alternative to the more "traditional" Primary/Secondary (P/S) plant configuration.

An installation must follow all the design criteria for such systems to be defined as Variable Primary Flow.

For this reason, the option 143 should be ordered only if the customer asks for a unit capable to manage the speed of the pump in a system designed to operate according to the Variable Primary Flow configuration and not as a general answer to "variable pump speed".

By selecting opt. 143, the chiller can manage the variable primary water flow according to the differential pressure measured in a specific point of the plant, selected by the plant designer. Daikin Applied Europe is not responsible for the plant configuration and cannot confirm the optimal position of the differential pressure transducer.

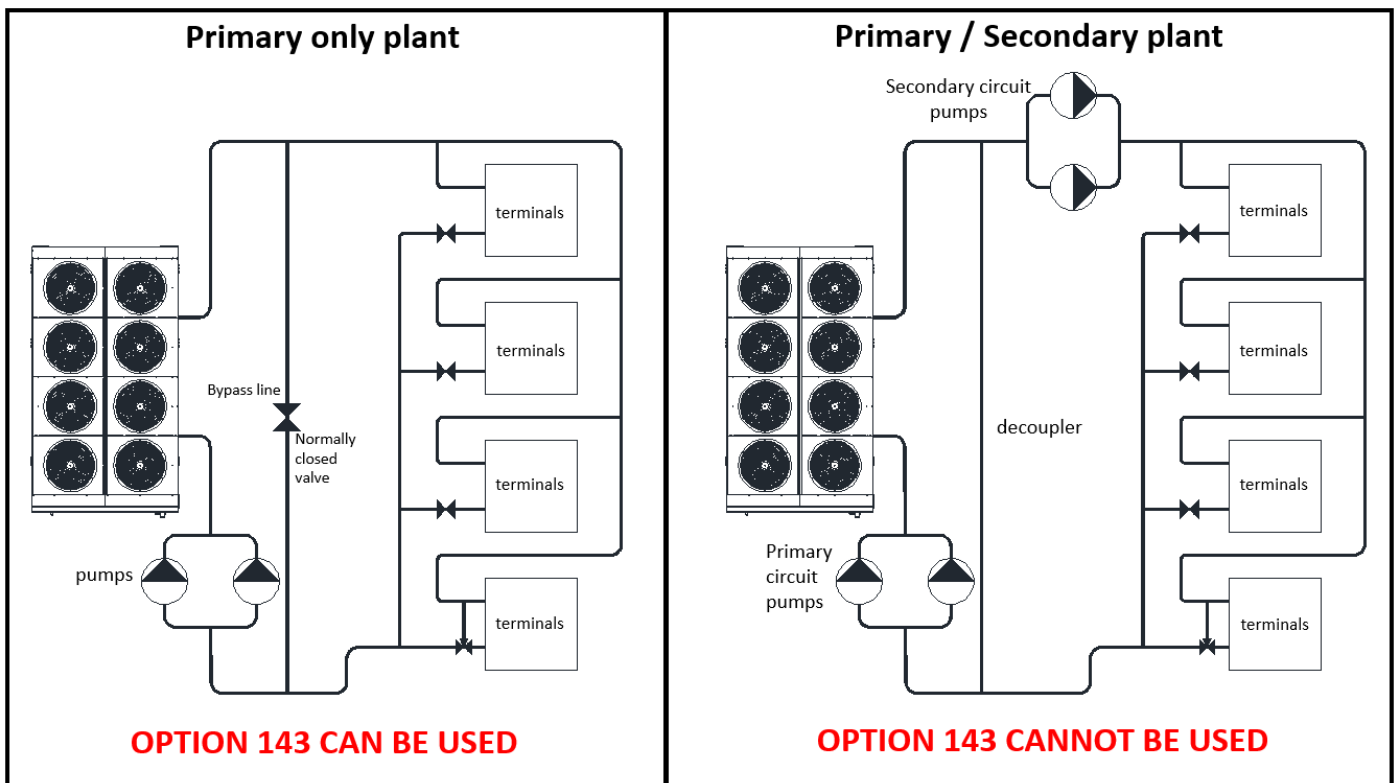
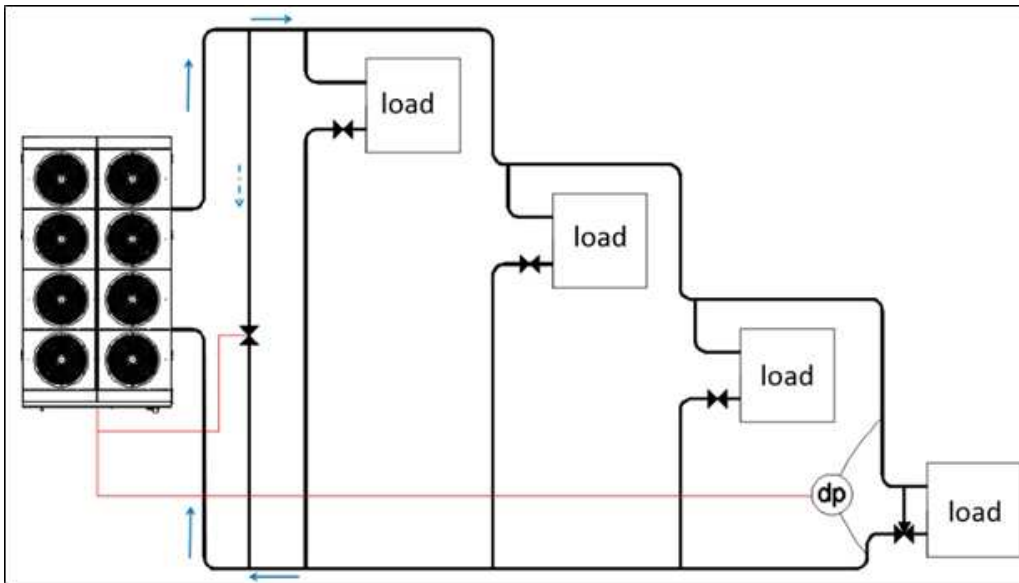

A bypass line (field supply) needs to be installed which guarantees that at all times the minimum water flow of the chiller is supplied (refer to the "Operating limit" chapter for indication on minimum water flow). The bypass valve will be an ON/OFF normally closed valve controlled by the chiller. In case the minimum water flow allowed is not reached, the chiller will open the bypass line restoring the water flow above the minimum value.

In case of multiple units installations in a primary only plant, to control the pump speed iCM is required. Master/Slave function does not support primary only chilled water systems with variable flow operation. For unit installed in Primary/Secondary plants the option Variable Primary Flow is not applicable. In this case a different control is required.

For different kind of water flow management iCM must be provided.

To operate in Primary/Secondary plants with variable flow in primary loop the iCM must be provided.

**Hydronic options summarizing table**

	Fixed speed	Variable speed pump (for "thermostat off" pump speed function or to be controlled with external BMS)	Variable Primary Flow management
ONE CENTRIFUGAL PUMP (LOW LIFT)	Opt 78	Opt 78 + Opt 120e	Opt 78 + Opt 120e + Opt 143
ONE CENTRIFUGAL PUMP (HIGH LIFT)	Opt 79	Opt 79 + Opt 120f	Opt 79 + Opt 120f + Opt 143
TWO CENTRIFUGAL PUMP (LOW LIFT)	Opt 80	Opt 80 + Opt 120g	Opt 80 + Opt 120g + Opt 143
TWO CENTRIFUGAL PUMP (HIGH LIFT)	Opt 81	Opt 81 + Opt 120h	Opt. 81 + Opt 120h + Opt 143

Note: OP.143 can be used only for units installed in a primary only plant to be controlled according to VPF strategy. Master/Slave function does not support primary only chilled water systems with variable flow operation.

**Differential Pressure Transducers - shipped loose - (OP. code 144).** *OP. incompatibility 172-173*

**Daikin on site modem with antenna (OP. code 155)**

Whenever LAN connection to the unit will not be available, connecting the unit to Daikin on Site will be possible through a dedicated 3G M2M modem that can be ordered from Factory. When ordered, the modem will be installed on the unit before leaving the Factory.

**HIGH AMBIENT KIT (OP. code 142A) - OP. incompatibility 99a-42-161-171-172-173-160-142B-142C**

The high ambient kit allows to increase the maximum operating ambient temperature for all the Single V units. Minimum ambient temperature is -10°C. Check the unit operating envelope for more information. This option may increase the height of the unit.

**HIGH AMBIENT KIT (OPERATION ABOVE 46°C ON-OFF FANS) (OP. code 142B)**

*OP. incompatibility 99-99a-42-161-171-172-173-160-142A-142C*

The high ambient kit allows to increase the maximum operating ambient temperature for all the Modular V units, with Standard and Low Sound Configurations.

Minimum ambient temperature is +10°C. Check the unit operating envelope for more information. This option may increase the height of the unit.

**HIGH AMBIENT KIT (OPERATION ABOVE 46°C BRUSHLESS FANS) (OP. code 142C)**

*OP. incompatibility 99-99a-42-161-171-172-173-160-142A-142B*

The high ambient kit allows to increase the maximum operating ambient temperature for all the Modular V units, with Reduced Sound Configuration.

Minimum ambient temperature is -18°C. Check the unit operating envelope for more information. This option may increase the height of the unit.

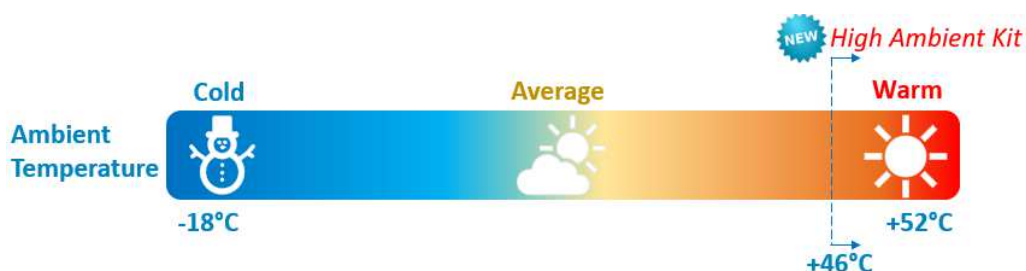

**100 PA ESP fans (OP. code 160 – Single V units only) - OP. incompatibility 99a-42-142A-171-172-173-161-142B-142C**

Special ON/OFF fans providing 100 Pa ESP. Unit power consumption and Sound Power level is increasing. The envelope doesn't change if the option is selected. This option may increase the height of the unit.

**200 PA ESP fans (OP. code 161 – Modular-V units only) - OP. incompatibility 99-99a-42-142A-160-142B-142C**

Special Brushless fans providing 200 Pa ESP. Unit power consumption and Sound Power level is increasing. The envelope doesn't change if the option is selected. This option may increase the height of the unit.

**FREE COOLING MIGRATION OPTIONS**



Free cooling options are available on EWAT-B ranges with “Refrigerant migration Free Cooling systems” (sometimes called “thermosiphon cooling”) as the chilled water circuit remains hydraulically always isolated. This technique uses the difference in temperature/pressure between the evaporator and condenser during cooler weather to drive refrigerant around the circuit without the need to operate the compressor.

Although this technology is theoretically applicable with any type of refrigerant, R32 with its reduced pressure drops is the only suitable solution to have an effective natural circulation without additional devices (e.g. circulation pumps) and without the mandatory use of glycol, required in the standard water free cooling technologies.

In brief, the higher temperature/pressure in the evaporator pushes the refrigerant gas to the coil where it condenses and falls back to the evaporator in a continuous circulation.

Technology effectiveness therefore is strictly related to 2 main aspects:

- Height difference between refrigerant level in the condenser and in the evaporator
- Temperature difference between condenser and evaporator

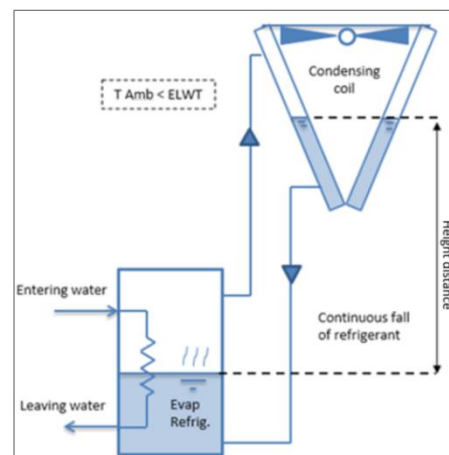

Free cooling migration is available in 3 different configurations differentiated by performances and equipment:

**Free Cooling Migration – Light (OP. code 171 - Modular-V units only) – OP. incompatibility 172, 173, 01, 03A, 134, 135, 136, 137, 42, 96, 120e, 120f, 120g, 120h, 142A, 160, 126, 127, 142B, 142C**

Once activated, this solution allows the refrigerant natural migration from evaporator to condenser, bypassing at the same time the compressors and expansion valve. Thanks to the design of the exchangers, with extremely low pressure drops, this solution does not need additional devices to pump the refrigerant, because it uses the natural migration principle. The Free-Cooling capacity obtainable is up to 25% of the Nominal Cooling capacity of the unit. OP. 171 includes OP. 61, 62, 99, 99a.

**Free Cooling Migration – Full (OP. code 172 - Modular-V units only) - OP. incompatibility 171, 173, 01, 03A, 21, 78, 79, 80, 81, 134, 135, 136, 137, 140, 42, 96, 120e, 120f, 120g, 120h, 142A, 143, 144, 160, 120e-FC, 120f-FC, 120g-FC, 120h-FC, 126, 127, 142B, 142C**

The option includes one additional flooded evaporator per circuit in parallel to the standard plates heat exchanger that allows an improvement of performances thanks to the enhanced height difference and the reduced approach between water and refrigerant typical of this type of technology.

This solution uses the same principle of light migration but, being equipped with the additional “Shell & Tube” refrigerant to water exchanger, it allows a bigger capacity obtainable.

Thanks to the design of the exchangers, with extremely low pressure drops and the increased height distance from condenser to evaporator, this solution can provide a Free Cooling capacity up to 75% of the nominal capacity of the unit. Also, this solution does not need additional devices to pump the refrigerant, because it uses the natural migration principle.

Unit layout is made of additional water connection for the free cooling operation (4 connections for the single circuit units or 6 connections for the twin circuit units – sample in the picture below). Plant layout has to be designed in order to address the water flow to the active heat exchanger (sample available in the section Free Cooling Migration - Full with Hydro Kit).

OP. 172 includes OP. 61, 99, 99a.

**Free Cooling Migration - Full with Hydro Kit (OP. code 173 - Modular-V units only) – OP. incompatibility 171, 01, 03A, 78, 79, 80, 81, 134, 135, 136, 137, 140, 42, 96, 120e, 120f, 120g, 120h, 142A, 143, 144, 160, 120e-FC, 120f-FC, 120g-FC, 120h-FC, 126, 127, 142B, 142C.** Includes “Free Cooling Migration – Full” and water side distribution piping that allows the automatic switch of the water flow between mechanical cooling and free cooling heat exchanger.

The Hydro Kit allows to decrease the number of connections from 6 (twin circuit) or 4 (single circuit) to 2 water connections, respect to the OP.172. The presence of the additional piping can affect unit footprint and weight. OP. 173 includes Opt 172, 61, 99a.

**\*NEW\*** Feasibilities to go under OAT down to -18°C with Option Free Cooling selected are accepted from Marketing department.

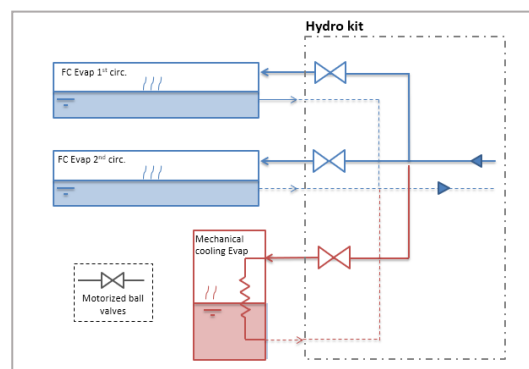

**Installation options – On request**

**Rubber anti vibration mounts (OP. code 75) – OP. incompatibility 77.**

Shipped loose, rubber mounts are to be positioned under the base frame of the unit during installation. Ideal to

---

reduce the vibrations when the unit is floor mounted.

**Spring anti vibration mounts (OP. code 77) - OP. incompatibility 75.**

Shipped loose, spring mounts are to be positioned under the base frame of the unit during installation. Ideal for dampening vibrations for installation on roofs and metallic structures.

**External tank without cabinet – 500 L (OP. code 83) - OP. incompatibility 84-87-88.**

Inertial tank for chilled water storage.

**External tank without cabinet – 1000 L (OP. code 84) - OP. incompatibility 83-87-88.**

Inertial tank for chilled water storage.

**External tank with cabinet – 500 L (OP. code 87) - OP. incompatibility 83-84-88.**

Inertial tank for chilled water storage with cabinet.

**External tank with cabinet – 1000 L (OP. code 88) - OP. incompatibility 83-84-87.**

Inertial tank for chilled water storage with cabinet.

## **Other options – On request**

**Container kit (OP. code 71) - OP. incompatibility 112.**

Specific solution designed to facilitate loading/unloading of the unit into the container and to reduce risk of damage.

**Transport kit (OP. code 112) - OP. incompatibility 71.**

Specific solution that offers shocks' absorption during unit transportation.

EWAT~B-SS/L

MODEL		EWAT085B -SS(L)B1	EWAT115B -SS(L)B1	EWAT135B -SS(L)B1	EWAT155B -SS(L)B2	EWAT175B -SS(L)B1	EWAT195B -SS(L)B2
<b>COOLING PERFORMANCE</b>							
Capacity - Cooling	kW	81	109	131	158	175	191
Capacity control - Type		Step	Step	Step	Step	Step	Step
Capacity control - Minimum capacity*	%	50	38	50	25	38	21
Unit power input - Cooling	kW	31,8	38,5	49,8	61,9	67,8	69,5
EER		2,55	2,83	2,64	2,55	2,58	2,75
IPLV		-	-	-	-	-	-
IPLV (+opt FANMOD <sup>(5)</sup> )		4,75	4,83	4,67	4,76	4,81	4,84
SEER <sup>(1)</sup>		-	-	-	-	-	-
η <sub>s</sub>	%	-	-	-	-	-	-
SEER (+opt FANMOD <sup>(5)</sup> ) <sup>(1)</sup>		4,10	4,40	4,10	4,10	4,48	4,34
η <sub>s</sub>	%	161,0	173,0	161,0	161,0	176,2	170,6
<b>DIMENSIONS</b>							
Height	mm	1801	1801	1801	1822	1801	1822
Width	mm	1204	1204	1204	1204	1204	1204
Length	mm	2110	2650	2650	3570	3170	4170
<b>WEIGHT</b>							
Unit Weight (SL Version)	kg	681 (691)	767 (777)	811 (820)	1007 (1028)	984 (994)	1166 (1087)
Operating Weight (SL Version)	kg	686 (696)	773 (783)	821 (830)	1014 (1035)	996 (1006)	1177 (1198)
<b>WATER HEAT EXCHANGER</b>							
Type <sup>(2)</sup>		PHE	PHE	PHE	PHE	PHE	PHE
Water Volume	l	5	6	9	7	12	11
Water flow rate	l/s	3,9	5,2	6,3	7,6	8,4	9,1
Water pressure drop <sup>(4)</sup>	kPa	27,4	34,5	26,5	64,2	41,8	45,9
Insulation material		Closed cell	Closed cell	Closed cell	Closed cell	Closed cell	Closed cell
<b>AIR HEAT EXCHANGER</b>							
Type <sup>(2)</sup>		Mch	Mch	Mch	Mch	Mch	Mch
<b>FAN</b>							
Type <sup>(2)</sup>		DPT	DPT	DPT	DPT	DPT	DPT
Drive <sup>(2)</sup>		Phase cut	Phase cut	Phase cut	Phase cut	Phase cut	Phase cut
Diameter	mm	450	450	450	450	450	450
Nominal air flow	l/s	6022	9036	9036	13354	12023	16710
Quantity	No,	4	6	6	8	8	10
Speed	rpm	1360	1360	1360	1360	1360	1360
Motor input	kW	1,8	2,7	2,7	3,6	3,6	4,5
<b>COMPRESSOR</b>							
Type		Scroll	Scroll	Scroll	Scroll	Scroll	Scroll
Oil charge	l	6,5	7,7	8,9	13,0	10,7	14,1
Quantity	No,	2	2	2	4	2	4
<b>SOUND LEVEL<sup>(3)</sup></b>							
Sound Power - Cooling (SL Version)	dB(A)	85 (84)	88 (86)	90 (87)	88 (87)	92 (89)	90 (88)
Sound Pressure level@1m distance Cooling (SL Version)	dB(A)	67 (66)	71 (69)	72 (69)	70 (68)	74 (71)	71 (70)
<b>REFRIGERANT CIRCUIT</b>							
Refrigerant type		R32	R32	R32	R32	R32	R32
Refrigerant charge	kg	7,5	8,5	8,5	13	11	14,5
N <sub>r</sub> of circuits	No,	1	1	1	2	1	2
<b>PIPING CONNECTIONS</b>							
Evaporator connections	mm	76,1	76,1	76,1	88,9	76,1	88,9

All the performances (Cooling capacity, unit power input in cooling and EER) are based on the following conditions: evaporator 12,0/7,0°C; ambient 35,0°C, unit at full load operation; operating fluid: Water; fouling factor = 0

(1) In accordance with standard EN14825:2013, comfort low temperature, average climate, SEER and η<sub>s</sub> values applicable Ecodesign regulation: (EU) No 2016/2281

(2) PHE: Plate Heat Exchanger; S&T: Single Pass Shell & Tube; MCH: Microchannel; DPT: Direct Propeller Type; DOL: Direct On Line - VFD: Inverter

(3) Sound power level (referred to evaporator 12/7°C, ambient 35°C full load operation) are measured in accordance with ISO 9614 and Eurovent 8/1 for Eurovent certified units. The certification refers only to the overall sound power level, the sound pressure is calculated from the sound power level and are for information only and not considered binding. The minimum capacity indicated is referred to unit operating at standard Eurovent conditions. Dimensions and weights are for indication only and not considered binding. Before designing the installation, consult the official drawings available from the factory at request. All the data are referred to standard unit without options. All data are subject to change without notice

(4) The value refers to the pressure drops in the evaporator only

(5) Option FANMOD consist in Continuous Fan Speed Regulation and improves part load operation, Single-V units are standardly equipped with continuous fan control, Modular-V units require opt 99- VFD fans

\*Capacity control - Minimum capacity is calculated as the ratio between the minimum horsepower of the smallest compressor respect to the maximum horsepower with all the compressors turned on.

Eurovent certified values

EWAT~B-SS/L

MODEL		EWAT205B -SS(L)B2	EWAT215B -SS(L)B1	EWAT240B -SS(L)B2	EWAT260B -SS(L)B2	EWAT290B -SS(L)B1	EWAT310B -SS(L)B2
<b>COOLING PERFORMANCE</b>							
Capacity - Cooling	kW	211	217	241	261	283	306
Capacity control - Type		Step	Step	Step	Step	Step	Step
Capacity control - Minimum capacity*	%	19	50	17	25	24	14
Unit power input - Cooling	kW	80,0	85,8	85,2	95,6	108	113
EER		2,63	2,53	2,83	2,73	2,62	2,72
IPLV		-	-	4,67	4,44	4,74	4,86
IPLV (+opt FANMOD <sup>(5)</sup> )		4,86	4,70	4,81	4,27	4,55	5,02
SEER <sup>(1)</sup>		-	-	4,37	4,14	4,42	4,52
$\eta_s$	%	-	-	171,8	162,6	173,8	177,8
SEER (+opt FANMOD <sup>(5)</sup> ) <sup>(1)</sup>		4,40	4,10	4,46	4,21	4,52	4,64
$\eta_s$	%	173,0	161,0	175,4	165,4	177,8	182,6
<b>DIMENSIONS</b>							
Height	mm	1822	1822	2540	2540	2540	2540
Width	mm	1204	1204	2224	2224	2224	2224
Length	mm	4170	3770	2338	2338	2368	3247
<b>WEIGHT</b>							
Unit Weight (SL Version)	kg	1158 (1179)	1184 (1194)	1712 (1815)	1739 (1842)	1912 (2004)	2186 (2289)
Operating Weight (SL Version)	kg	1169 (1190)	1200 (1210)	1723 (1826)	1750 (1853)	1869 (1951)	2205 (2308)
<b>WATER HEAT EXCHANGER</b>							
Type <sup>(2)</sup>		PHE	PHE	PHE	PHE	PHE	PHE
Water Volume	l	11	16	11	11	16	19
Water flow rate	l/s	10,1	10,4	11,5	12,4	13,5	14,6
Water pressure drop <sup>(4)</sup>	kPa	54,5	41,5	69,7	80,0	66,8	46,4
Insulation material		Closed cell	Closed cell	Closed cell	Closed cell	Closed cell	Closed cell
<b>AIR HEAT EXCHANGER</b>							
Type <sup>(2)</sup>		Mch	Mch	MCH	MCH	MCH	MCH
<b>FAN</b>							
Type <sup>(2)</sup>		DPT	DPT	DPT	DPT	DPT	DPT
Drive <sup>(2)</sup>		Phase cut	Phase cut	On-off	On-off	On-off	On-off
Diameter	mm	450	450	800	800	800	800
Nominal air flow	l/s	16710	15057	20306	20306	20306	25382
Quantity	No,	10	10	4	4	4	5
Speed	rpm	1360	1360	900	900	900	900
Motor input	kW	4,5	4,5	7,2	7,2	7,2	9,0
<b>COMPRESSOR</b>							
Type		Scroll	Scroll	Scroll	Scroll	Scroll	Scroll
Oil charge	l	15,3	12,6	16,5	17,7	17,0	19,1
Quantity	No,	4	2	4	4	3	4
<b>SOUND LEVEL <sup>(3)</sup></b>							
Sound Power - Cooling (SL Version)	dB(A)	91 (89)	93 (90)	93 (91)	94 (91)	95 (91)	95 (92)
Sound Pressure level@1m distance Cooling (SL Version)	dB(A)	72 (70)	75 (72)	74 (72)	75 (72)	76 (72)	75 (72)
<b>REFRIGERANT CIRCUIT</b>							
Refrigerant type		R32	R32	R32	R32	R32	R32
Refrigerant charge	kg	14,5	13	19	19	19	25,5
N <sub>r</sub> of circuits	No,	2	1	2	2	1	2
<b>PIPING CONNECTIONS</b>							
Evaporator connections	mm	88,9	76,1	88,9	88,9	76,1	88,9

All the performances (Cooling capacity, unit power input in cooling and EER) are based on the following conditions: evaporator 12,0/7,0°C; ambient 35,0°C, unit at full load operation; operating fluid: Water; fouling factor = 0

(1) In accordance with standard EN14825:2013, comfort low temperature, average climate, SEER and  $\mu_s$  values applicable Ecodesign regulation: (EU) No 2016/2281

(2) PHE: Plate Heat Exchanger; S&T: Single Pass Shell & Tube; MCH: Microchannel; DPT: Direct Propeller Type; DOL: Direct On Line - VFD: Inverter

(3) Sound power level (referred to evaporator 12/7°C, ambient 35°C full load operation) are measured in accordance with ISO 9614 and Eurovent 8/1 for Eurovent certified units. The certification refers only to the overall sound power level, the sound pressure is calculated from the sound power level and are for information only and not considered binding. The minimum capacity indicated is referred to unit operating at standard Eurovent conditions. Dimensions and weights are for indication only and not considered binding. Before designing the installation, consult the official drawings available from the factory at request. All the data are referred to standard unit without options. All data are subject to change without notice

(4) The value refers to the pressure drops in the evaporator only

(5) Option FANMOD consist in Continuous Fan Speed Regulation and improves part load operation, Single-V units are standardly equipped with continuous fan control, Modular-V units require opt 99- VFD fans

\*Capacity control - Minimum capacity is calculated as the ratio between the minimum horsepower of the smallest compressor respect to the maximum horsepower with all the compressors turned on.

Eurovent certified values

EWAT~B-SS/L

MODEL		EWAT330B -SS(L)B2	EWAT340B -SS(L)B1	EWAT350B -SS(L)B2	EWAT420B -SS(L)B2	EWAT460B -SS(L)B2	EWAT510B -SS(L)B2
<b>COOLING PERFORMANCE</b>							
Capacity - Cooling	kW	330	344	350	416	468	513
Capacity control - Type		Step	Step	Step	Step	Step	Step
Capacity control - Minimum capacity*	%	13	33	19	17	15	14
Unit power input - Cooling	kW	122	117	132	147	171	186
EER		2,71	2,94	2,65	2,84	2,73	2,76
IPLV		4,63	4,80	4,56	4,87	4,84	4,81
IPLV (+opt FANMOD <sup>(5)</sup> )		4,75	5,00	4,7	4,91	4,89	4,90
SEER <sup>(1)</sup>		4,33	4,44	4,24	4,56	4,56	4,56
η <sub>s</sub>	%	170,2	174,6	166,6	179,4	179,4	179,4
SEER (+opt FANMOD <sup>(5)</sup> ) <sup>(1)</sup>		4,41	4,66	4,31	4,57	4,63	4,62
η <sub>s</sub>	%	173,4	183,4	169,4	179,8	182,2	181,8
<b>DIMENSIONS</b>							
Height	mm	2540	2540	2540	2540	2540	2540
Width	mm	2224	2224	2224	2224	2224	2224
Length	mm	3247	3230	3247	4135	4135	4135
<b>WEIGHT</b>							
Unit Weight (SL Version)	kg	2214 (2317)	2343 (2434)	2242 (2345)	2721 (2824)	2881 (3066)	3037 (3223)
Operating Weight (SL Version)	kg	2233 (2336)	2363 (2454)	2261 (2364)	2749 (2852)	2909 (3094)	3065 (3251)
<b>WATER HEAT EXCHANGER</b>							
Type <sup>(2)</sup>		PHE	PHE	PHE	PHE	PHE	PHE
Water Volume	l	19	20	19	28	28	28
Water flow rate	l/s	15,7	16,4	16,7	19,9	22,3	24,5
Water pressure drop <sup>(4)</sup>	kPa	52,9	77,3	59,0	54,6	67,3	79,7
Insulation material		Closed cell	Closed cell	7Closed cell	Closed cell	Closed cell	Closed cell
<b>AIR HEAT EXCHANGER</b>							
Type <sup>(2)</sup>		MCH	MCH	MCH	MCH	MCH	MCH
<b>FAN</b>							
Type <sup>(2)</sup>		DPT	DPT	DPT	DPT	DPT	DPT
Drive <sup>(2)</sup>		On-off	On-off	On-off	On-off	On-off	On-off
Diameter	mm	800	800	800	800	800	800
Nominal air flow	l/s	25382	30459	25382	35535	35535	40612
Quantity	No,	5	6	5	7	7	8
Speed	rpm	900	900	900	900	900	900
Motor input	kW	9,0	10,8	9,0	12,6	12,6	14,3
<b>COMPRESSOR</b>							
Type		Scroll	Scroll	Scroll	Scroll	Scroll	Scroll
Oil charge	l	20,2	18,9	21,4	23,3	27,7	29,6
Quantity	No,	4	3	4	4	5	5
<b>SOUND LEVEL<sup>(3)</sup></b>							
Sound Power - Cooling (SL Version)	dB(A)	95 (92)	96 (93)	96 (92)	97 (93)	97 (93)	98 (94)
Sound Pressure level@1m distance Cooling (SL Version)	dB(A)	76 (72)	77 (73)	76 (72)	77 (73)	77 (73)	78 (74)
<b>REFRIGERANT CIRCUIT</b>							
Refrigerant type		R32	R32	R32	R32	R32	R32
Refrigerant charge	kg	25	26	24	34,5	36	41
N <sub>r</sub> of circuits	No,	2	1	2	2	2	2
<b>PIPING CONNECTIONS</b>							
Evaporator connections	mm	88,9	76,1	88,9	88,9	88,9	88,9

All the performances (Cooling capacity, unit power input in cooling and EER) are based on the following conditions: evaporator 12,0/7,0°C; ambient 35,0°C, unit at full load operation; operating fluid: Water; fouling factor = 0

(1) In accordance with standard EN14825:2013, comfort low temperature, average climate, SEER and η<sub>s</sub> values applicable Ecodesign regulation: (EU) No 2016/2281

(2) PHE: Plate Heat Exchanger; S&T: Single Pass Shell & Tube; MCH: Microchannel; DPT: Direct Propeller Type; DOL: Direct On Line - VFD: Inverter

(3) Sound power level (referred to evaporator 12/7°C, ambient 35°C full load operation) are measured in accordance with ISO 9614 and Eurovent 8/1 for Eurovent certified units. The certification refers only to the overall sound power level, the sound pressure is calculated from the sound power level and are for information only and not considered binding. The minimum capacity indicated is referred to unit operating at standard Eurovent conditions. Dimensions and weights are for indication only and not considered binding. Before designing the installation, consult the official drawings available from the factory at request. All the data are referred to standard unit without options. All data are subject to change without notice

(4) The value refers to the pressure drops in the evaporator only

(5) Option FANMOD consist in Continuous Fan Speed Regulation and improves part load operation, Single-V units are standardly equipped with continuous fan control, Modular-V units require opt 99- VFD fans

\*Capacity control - Minimum capacity is calculated as the ratio between the minimum horsepower of the smallest compressor respect to the maximum horsepower with all the compressors turned on.

Eurovent certified values

**EWAT~B-SS/L**

MODEL		EWAT570B -SS(L)B2	EWAT610B -SS(L)B2	EWAT670B -SS(L)B2
<b>COOLING PERFORMANCE</b>				
Capacity - Cooling	kW	567	612	668
Capacity control - Type		Step	Step	Step
Capacity control - Minimum capacity*	%	12	11	17
Unit power input - Cooling	kW	216	230	238
EER		2,63	2,66	2,80
IPLV		4,89	4,90	4,86
IPLV (+opt FANMOD <sup>(5)</sup> )		4,93	4,89	5,00
SEER <sup>(1)</sup>		4,56	4,55	4,55
$\eta_s$	%	179,4	179,0	179,0
SEER (+opt FANMOD <sup>(5)</sup> ) <sup>(1)</sup>		4,56	4,58	4,67
$\eta_s$	%	179,4	180,2	183,8
<b>DIMENSIONS</b>				
Height	mm	2540	2540	2540
Width	mm	2224	2224	2224
Length	mm	4135	5034	5888
<b>WEIGHT</b>				
Unit Weight (SL Version)	kg	3278 (3484)	3712 (3918)	4073 (4279)
Operating Weight (SL Version)	kg	3320 (3526)	3754 (3960)	4115 (4321)
<b>WATER HEAT EXCHANGER</b>				
Type <sup>(2)</sup>		PHE	PHE	PHE
Water Volume	l	42	42	42
Water flow rate	l/s	27,0	29,2	31,9
Water pressure drop <sup>(4)</sup>	kPa	65,5	75,2	88,1
Insulation material		Closed cell	Closed cell	Closed cell
<b>AIR HEAT EXCHANGER</b>				
Type <sup>(2)</sup>		MCH	MCH	MCH
<b>FAN</b>				
Type <sup>(2)</sup>		DPT	DPT	DPT
Drive <sup>(2)</sup>		On-off	On-off	On-off
Diameter	mm	800	800	800
Nominal air flow	l/s	40612	45688	55841
Quantity	No,	8	9	11
Speed	rpm	900	900	900
Motor input	kW	14,3	16,1	19,7
<b>COMPRESSOR</b>				
Type		Scroll	Scroll	Scroll
Oil charge	l	34,0	35,9	37,8
Quantity	No,	6	6	6
<b>SOUND LEVEL<sup>(3)</sup></b>				
Sound Power - Cooling (SL Version)	dB(A)	98 (94)	98 (95)	99 (95)
Sound Pressure level@1m distance Cooling (SL Version)	dB(A)	78 (74)	78 (74)	78 (75)
<b>REFRIGERANT CIRCUIT</b>				
Refrigerant type		R32	R32	R32
Refrigerant charge	kg	42	46,5	52,5
N, of circuits	No,	2	2	2
<b>PIPING CONNECTIONS</b>				
Evaporator connections	mm	114,3	114,3	114,3

All the performances (Cooling capacity, unit power input in cooling and EER) are based on the following conditions: evaporator 12,0/7,0°C; ambient 35,0°C, unit at full load operation; operating fluid: Water; fouling factor = 0

(1) In accordance with standard EN14825:2013, comfort low temperature, average climate, SEER and  $\mu_s$  values applicable Ecodesign regulation: (EU) No 2016/2281

(2) PHE: Plate Heat Exchanger; S&T: Single Pass Shell & Tube; MCH: Microchannel; DPT: Direct Propeller Type; DOL: Direct On Line - VFD: Inverter

(3) Sound power level (referred to evaporator 12/7°C, ambient 35°C full load operation) are measured in accordance with ISO 9614 and Eurovent 8/1 for Eurovent certified units. The certification refers only to the overall sound power level, the sound pressure is calculated from the sound power level and are for information only and not considered binding. The minimum capacity indicated is referred to unit operating at standard Eurovent conditions. Dimensions and weights are for indication only and not considered binding. Before designing the installation, consult the official drawings available from the factory at request. All the data are referred to standard unit without options. All data are subject to change without notice

(4) The value refers to the pressure drops in the evaporator only

(5) Option FANMOD consist in Continuous Fan Speed Regulation and improves part load operation, Single-V units are standardly equipped with continuous fan control, Modular-V units require opt 99- VFD fans

\*Capacity control - Minimum capacity is calculated as the ratio between the minimum horsepower of the smallest compressor respect to the maximum horsepower with all the compressors turned on.

Eurovent certified values

EWAT~B-SR

MODEL		EWAT085B -SRB1	EWAT115B -SRB1	EWAT135B -SRB1	EWAT155B -SRB2	EWAT175B -SRB1	EWAT195B -SRB2
<b>COOLING PERFORMANCE</b>							
Capacity - Cooling	kW	76	105	124	150	165	181
Capacity control - Type		Step	Step	Step	Step	Step	Step
Capacity control - Minimum capacity*	%	50	38	50	25	38	21
Unit power input - Cooling	kW	33,7	40,3	53,0	65,9	73,0	73,2
EER		2,27	2,61	2,34	2,28	2,26	2,48
IPLV (+opt FANMOD <sup>(5)</sup> )		4,71	4,84	4,63	4,62	4,84	4,64
SEER (+opt FANMOD <sup>(5)</sup> ) <sup>(1)</sup>		4,10	4,40	4,10	4,10	4,23	4,13
$\eta_s$	%	161,0	173,0	161,0	161,0	166,2	162,2
<b>DIMENSIONS</b>							
Height	mm	1801	1801	1801	1822	1801	1822
Width	mm	1204	1204	1204	1204	1204	1204
Length	mm	2110	2650	2650	3570	3170	4170
<b>WEIGHT</b>							
Unit Weight	kg	691	777	821	1028	994	1187
Operating Weight	kg	696	783	830	1035	1006	1198
<b>WATER HEAT EXCHANGER</b>							
Type <sup>(2)</sup>		PHE	PHE	PHE	PHE	PHE	PHE
Water Volume	l	5	6	9	7	12	11
Water flow rate	l/s	3,7	5,0	5,9	7,2	7,9	8,7
Water pressure drop <sup>(4)</sup>	kPa	24,6	32,2	23,8	58,5	37,6	41,7
Insulation material		Closed cell	Closed cell	Closed cell	Closed cell	Closed cell	Closed cell
<b>AIR HEAT EXCHANGER</b>							
Type <sup>(2)</sup>		Mch	Mch	Mch	Mch	Mch	Mch
<b>FAN</b>							
Type <sup>(2)</sup>		DPT	DPT	DPT	DPT	DPT	DPT
Drive <sup>(2)</sup>		Phase cut	Phase cut	Phase cut	Phase cut	Phase cut	Phase cut
Diameter	mm	450	450	450	450	450	450
Nominal air flow	l/s	4929	7396	7396	11352	9838	14202
Quantity	No,	4	6	6	8	8	10
Speed	rpm	1200	1200	1200	1200	1200	1200
Motor input	kW	1,4	2,2	2,2	2,9	2,9	3,6
<b>COMPRESSOR</b>							
Type		Scroll	Scroll	Scroll	Scroll	Scroll	Scroll
Oil charge	l	6,5	7,7	8,9	13,0	10,7	14,1
Quantity	No,	2	2	2	4	2	4
<b>SOUND LEVEL<sup>(3)</sup></b>							
Sound Power - Cooling	dB(A)	77	83	84	82	86	84
Sound Pressure level@1m distance Cooling	dB(A)	61	65	66	63	68	65
<b>REFRIGERANT CIRCUIT</b>							
Refrigerant type		R32	R32	R32	R32	R32	R32
Refrigerant charge	kg	7,5	8,5	8,5	13	11	14,5
N, of circuits	No,	1	1	1	2	1	2
<b>PIPING CONNECTIONS</b>							
Evaporator water inlet/outlet	mm	76,1	76,1	76,1	88,9	76,1	88,9

All the performances (Cooling capacity, unit power input in cooling and EER) are based on the following conditions: evaporator 12,0/7,0°C; ambient 35,0°C, unit at full load operation; operating fluid: Water; fouling factor = 0

(1) In accordance with standard EN14825:2013, comfort low temperature, average climate, SEER and  $\mu_s$  values applicable Ecodesign regulation: (EU) No 2016/2281

(2) PHE: Plate Heat Exchanger; S&T: Single Pass Shell & Tube; MCH: Microchannel; DPT: Direct Propeller Type; DOL: Direct On Line - VFD: Inverter

(3) Sound power level (referred to evaporator 12/7°C, ambient 35°C full load operation) are measured in accordance with ISO 9614 and Eurovent 8/1 for Eurovent certified units. The certification refers only to the overall sound power level, the sound pressure is calculated from the sound power level and are for information only and not considered binding. The minimum capacity indicated is referred to unit operating at standard Eurovent conditions. Dimensions and weights are for indication only and not considered binding. Before designing the installation, consult the official drawings available from the factory at request. All the data are referred to standard unit without options. All data are subject to change without notice

(4) The value refers to the pressure drops in the evaporator only

(5) Option FANMOD consist in Continuous Fan Speed Regulation and improves part load operation, Single-V units are standardly equipped with continuous fan control, Modular-V units require opt 99- VFD fans

\*Capacity control - Minimum capacity is calculated as the ratio between the minimum horsepower of the smallest compressor respect to the maximum horsepower with all the compressors turned on.

EWAT~B-SR

MODEL		EWAT205B -SRB2	EWAT215B -SRB1	EWAT240B -SRB2	EWAT260B -SRB2	EWAT290B -SRB1	EWAT310B -SRB2
<b>COOLING PERFORMANCE</b>							
Capacity - Cooling	kW	201	204	231	249	266	290
Capacity control - Type		Step	Step	Step	Step	Step	Step
Capacity control - Minimum capacity*	%	19	50	17	25	24	14
Unit power input - Cooling	kW	84,6	91,9	89,0	99,9	115,0	119,0
EER		2,37	2,21	2,60	2,49	2,31	2,44
IPLV (+opt FANMOD <sup>(5)</sup> )		4,91	4,66	4,93	4,27	4,51	4,82
SEER (+opt FANMOD <sup>(5)</sup> ) <sup>(1)</sup>		4,27	4,10	4,57	4,18	4,43	4,38
$\eta_s$	%	167,8	161,0	179,8	164,2	174,2	172,2
<b>DIMENSIONS</b>							
Height	mm	1822	1822	2540	2540	2540	2540
Width	mm	1204	1204	2224	2224	2224	2224
Length	mm	4170	3770	2338	2338	2368	3247
<b>WEIGHT</b>							
Unit Weight	kg	1179	1194	1815	1842	2004	2289
Operating Weight	kg	1190	1210	1826	1853	2020	2308
<b>WATER HEAT EXCHANGER</b>							
Type <sup>(2)</sup>		PHE	PHE	PHE	PHE	PHE	PHE
Water Volume	l	11	16	11	11	16	19
Water flow rate	l/s	9,6	9,7	11,0	11,9	12,7	13,9
Water pressure drop <sup>(4)</sup>	kPa	49,9	36,9	64,5	73,6	59,9	42,1
Insulation material		Closed cell	Closed cell	Closed cell	Closed cell	Closed cell	Closed cell
<b>AIR HEAT EXCHANGER</b>							
Type <sup>(2)</sup>		Mch	Mch	Mch	Mch	Mch	Mch
<b>FAN</b>							
Type <sup>(2)</sup>		DPT	DPT	DPT	DPT	DPT	DPT
Drive <sup>(2)</sup>		Phase cut	Phase cut	VFD fans	VFD fans	VFD fans	VFD fans
Diameter	mm	450	450	800	800	800	800
Nominal air flow	l/s	14202	12325	17064	17064	17064	21330
Quantity	No,	10	10	4	4	4	5
Speed	rpm	1200	1200	780	780	780	780
Motor input	kW	3,6	3,6	4,7	4,7	4,7	5,9
<b>COMPRESSOR</b>							
Type		Scroll	Scroll	Scroll	Scroll	Scroll	Scroll
Oil charge	l	15,3	12,6	16,5	17,7	17,0	19,1
Quantity	No,	4	2	4	4	3	4
<b>SOUND LEVEL<sup>(3)</sup></b>							
Sound Power - Cooling	dB(A)	85	88	87	87	88	88
Sound Pressure level@1m distance Cooling	dB(A)	67	69	68	68	69	69
<b>REFRIGERANT CIRCUIT</b>							
Refrigerant type		R32	R32	R32	R32	R32	R32
Refrigerant charge	kg	14,5	13	19	19	19	25,5
N, of circuits	No,	2	1	2	2	1	2
<b>PIPING CONNECTIONS</b>							
Evaporator water inlet/outlet	mm	88,9	76,1	88,9	88,9	76,1	88,9

All the performances (Cooling capacity, unit power input in cooling and EER) are based on the following conditions: evaporator 12,0/7,0°C; ambient 35,0°C, unit at full load operation; operating fluid: Water; fouling factor = 0

(1) In accordance with standard EN14825:2013, comfort low temperature, average climate, SEER and  $\mu_s$  values applicable Ecodesign regulation: (EU) No 2016/2281

(2) PHE: Plate Heat Exchanger; S&T: Single Pass Shell & Tube; MCH: Microchannel; DPT: Direct Propeller Type; DOL: Direct On Line - VFD: Inverter

(3) Sound power level (referred to evaporator 12/7°C, ambient 35°C full load operation) are measured in accordance with ISO 9614 and Eurovent 8/1 for Eurovent certified units. The certification refers only to the overall sound power level, the sound pressure is calculated from the sound power level and are for information only and not considered binding. The minimum capacity indicated is referred to unit operating at standard Eurovent conditions. Dimensions and weights are for indication only and not considered binding. Before designing the installation, consult the official drawings available from the factory at request. All the data are referred to standard unit without options. All data are subject to change without notice

(4) The value refers to the pressure drops in the evaporator only

(5) Option FANMOD consist in Continuous Fan Speed Regulation and improves part load operation, Single-V units are standardly equipped with continuous fan control, Modular-V units require opt 99- VFD fans

\*Capacity control - Minimum capacity is calculated as the ratio between the minimum horsepower of the smallest compressor respect to the maximum horsepower with all the compressors turned on.



EWAT~B-SR

MODEL		EWAT330B -SRB2	EWAT340B -SRB1	EWAT350B -SRB2	EWAT420B -SRB2	EWAT460B -SRB2	EWAT510B -SRB2
<b>COOLING PERFORMANCE</b>							
Capacity - Cooling	kW	312	330	331	398	444	488
Capacity control - Type		Step	Step	Step	Step	Step	Step
Capacity control - Minimum capacity*	%	13	33	19	17	15	14
Unit power input - Cooling	kW	129,0	122,0	140,0	147,0	181,0	197,0
EER		2,41	2,70	2,35	2,71	2,45	2,48
IPLV (+opt FANMOD <sup>(5)</sup> )		4,70	5,00	4,72	4,81	4,92	4,93
SEER (+opt FANMOD <sup>(5)</sup> ) <sup>(1)</sup>		4,42	4,55	4,20	4,55	4,57	4,56
η <sub>s</sub>	%	173,8	179,0	165,0	179,0	179,8	179,4
<b>DIMENSIONS</b>							
Height	mm	2540	2540	2540	2540	2540	2540
Width	mm	2224	2224	2224	2224	2224	2224
Length	mm	3247	3230	3247	4135	4135	4135
<b>WEIGHT</b>							
Unit Weight	kg	2317	2434	2345	2824	3066	3223
Operating Weight	kg	2336	2454	2364	2852	3094	3251
<b>WATER HEAT EXCHANGER</b>							
Type <sup>(2)</sup>		PHE	PHE	PHE	PHE	PHE	PHE
Water Volume	l	19	20	19	28	28	28
Water flow rate	l/s	14,9	15,7	15,8	19,0	21,2	23,3
Water pressure drop <sup>(4)</sup>	kPa	47,9	71,7	53,3	50,5	61,2	72,7
Insulation material		Closed cell	Closed cell	Closed cell	Closed cell	Closed cell	Closed cell
<b>AIR HEAT EXCHANGER</b>							
Type <sup>(2)</sup>		Mch	Mch	Mch	Mch	Mch	Mch
<b>FAN</b>							
Type <sup>(2)</sup>		DPT	DPT	DPT	DPT	DPT	DPT
Drive <sup>(2)</sup>		VFD fans	VFD fans	VFD fans	VFD fans	VFD fans	VFD fans
Diameter	mm	800	800	800	800	800	800
Nominal air flow	l/s	21330	25596	21330	29862	29862	34128
Quantity	No,	5	6	5	7	7	8
Speed	rpm	780	780	780	780	780	780
Motor input	kW	5,9	7,1	5,9	8,2	8,2	9,4
<b>COMPRESSOR</b>							
Type		Scroll	Scroll	Scroll	Scroll	Scroll	Scroll
Oil charge	l	20,2	18,9	21,4	23,3	27,7	29,6
Quantity	No,	4	3	4	4	5	5
<b>SOUND LEVEL <sup>(3)</sup></b>							
Sound Power - Cooling	dB(A)	88	89	88	90	90	90
Sound Pressure level@1m distance Cooling	dB(A)	69	70	69	70	70	71
<b>REFRIGERANT CIRCUIT</b>							
Refrigerant type		R32	R32	R32	R32	R32	R32
Refrigerant charge	kg	25	26	24	34,5	36	41
N <sub>r</sub> of circuits	No,	2	1	2	2	2	2
<b>PIPING CONNECTIONS</b>							
Evaporator water inlet/outlet	mm	88,9	76,1	88,9	88,9	88,9	88,9

All the performances (Cooling capacity, unit power input in cooling and EER) are based on the following conditions: evaporator 12,0/7,0°C; ambient 35,0°C, unit at full load operation; operating fluid: Water; fouling factor = 0

(1) In accordance with standard EN14825:2013, comfort low temperature, average climate, SEER and η<sub>s</sub> values applicable Ecodesign regulation: (EU) No 2016/2281

(2) PHE: Plate Heat Exchanger; S&T: Single Pass Shell & Tube; MCH: Microchannel; DPT: Direct Propeller Type; DOL: Direct On Line - VFD: Inverter

(3) Sound power level (referred to evaporator 12/7°C, ambient 35°C full load operation) are measured in accordance with ISO 9614 and Eurovent 8/1 for Eurovent certified units. The certification refers only to the overall sound power level, the sound pressure is calculated from the sound power level and are for information only and not considered binding. The minimum capacity indicated is referred to unit operating at standard Eurovent conditions. Dimensions and weights are for indication only and not considered binding. Before designing the installation, consult the official drawings available from the factory at request. All the data are referred to standard unit without options. All data are subject to change without notice

(4) The value refers to the pressure drops in the evaporator only

(5) Option FANMOD consist in Continuous Fan Speed Regulation and improves part load operation, Single-V units are standardly equipped with continuous fan control, Modular-V units require opt 99- VFD fans

\*Capacity control - Minimum capacity is calculated as the ratio between the minimum horsepower of the smallest compressor respect to the maximum horsepower with all the compressors turned on.

**EWAT~B-SR**

MODEL		EWAT570B -SRB2	EWAT610B -SRB2	EWAT670B -SRB2
<b>COOLING PERFORMANCE</b>				
Capacity - Cooling	kW	534	579	638
Capacity control - Type		Step	Step	Step
Capacity control - Minimum capacity*	%	12	11	17
Unit power input - Cooling	kW	230,0	244,0	251,0
EER		2,32	2,37	2,55
IPLV (+opt FANMOD <sup>(5)</sup> )		5,04	5,03	5,01
SEER (+opt FANMOD <sup>(5)</sup> ) <sup>(1)</sup>		4,55	4,55	4,55
$\eta_s$	%	179,0	179,0	179,0
<b>DIMENSIONS</b>				
Height	mm	2540	2540	2540
Width	mm	2224	2224	2224
Length	mm	4135	5034	5888
<b>WEIGHT</b>				
Unit Weight	kg	3484	3918	4279
Operating Weight	kg	3526	3960	4321
<b>WATER HEAT EXCHANGER</b>				
Type <sup>(2)</sup>		PHE	PHE	PHE
Water Volume	l	42	42	42
Water flow rate	l/s	25,5	27,6	30,4
Water pressure drop <sup>(4)</sup>	kPa	58,9	68,1	81,1
Insulation material		Closed cell	Closed cell	Closed cell
<b>AIR HEAT EXCHANGER</b>				
Type <sup>(2)</sup>		Mch	Mch	Mch
<b>FAN</b>				
Type <sup>(2)</sup>		DPT	DPT	DPT
Drive <sup>(2)</sup>		VFD fans	VFD fans	VFD fans
Diameter	mm	800	800	800
Nominal air flow	l/s	34128	38394	46926
Quantity	No,	8	9	11
Speed	rpm	780	780	780
Motor input	kW	9,4	10,6	12,9
<b>COMPRESSOR</b>				
Type		Scroll	Scroll	Scroll
Oil charge	l	34,0	35,9	37,8
Quantity	No,	6	6	6
<b>SOUND LEVEL <sup>(3)</sup></b>				
Sound Power - Cooling	dB(A)	91	91	92
Sound Pressure level@1m distance Cooling	dB(A)	71	71	71
<b>REFRIGERANT CIRCUIT</b>				
Refrigerant type		R32	R32	R32
Refrigerant charge	kg	42	46,5	52,5
N, of circuits	No,	2	2	2
<b>PIPING CONNECTIONS</b>				
Evaporator water inlet/outlet	mm	114,3	114,3	114,3

All the performances (Cooling capacity, unit power input in cooling and EER) are based on the following conditions: evaporator 12,0/7,0°C; ambient 35,0°C, unit at full load operation; operating fluid: Water; fouling factor = 0

(1) In accordance with standard EN14825:2013, comfort low temperature, average climate, SEER and  $\mu_s$  values applicable Ecodesign regulation: (EU) No 2016/2281

(2) PHE: Plate Heat Exchanger; S&T: Single Pass Shell & Tube; MCH: Microchannel; DPT: Direct Propeller Type; DOL: Direct On Line - VFD: Inverter

(3) Sound power level (referred to evaporator 12/7°C, ambient 35°C full load operation) are measured in accordance with ISO 9614 and Eurovent 8/1 for Eurovent certified units. The certification refers only to the overall sound power level, the sound pressure is calculated from the sound power level and are for information only and not considered binding. The minimum capacity indicated is referred to unit operating at standard Eurovent conditions. Dimensions and weights are for indication only and not considered binding. Before designing the installation, consult the official drawings available from the factory at request. All the data are referred to standard unit without options. All data are subject to change without notice

(4) The value refers to the pressure drops in the evaporator only

(5) Option FANMOD consist in Continuous Fan Speed Regulation and improves part load operation, Single-V units are standardly equipped with continuous fan control, Modular-V units require opt 99- VFD fans

\*Capacity control - Minimum capacity is calculated as the ratio between the minimum horsepower of the smallest compressor respect to the maximum horsepower with all the compressors turned on.

EWAT~B-XS/L

MODEL		EWAT085B -XS(L)B1	EWAT115B -XS(L)B1	EWAT145B -XS(L)B1	EWAT180B -XS(L)B2	EWAT185B -XS(L)B1	EWAT200B -XS(L)B2
<b>COOLING PERFORMANCE</b>							
Capacity - Cooling	kW	88	114	143	179	183	201
Capacity control - Type		Step	Step	Step	Step	Step	Step
Capacity control - Minimum capacity*	%	50	38	50	25	38	21
Unit power input - Cooling	kW	28,8	36,6	44,4	57,0	63,6	65,7
EER		3,05	3,12	3,23	3,14	2,87	3,06
IPLV		-	-	-	4,65	-	4,67
IPLV (+opt FANMOD <sup>(5)</sup> )		4,83	4,90	4,88	5,11	4,74	4,87
SEER <sup>(1)</sup>		-	-	-	4,38	-	4,40
η <sub>s</sub>	%	-	-	-	168,8	-	169,5
SEER (+opt FANMOD <sup>(5)</sup> ) <sup>(1)</sup>		4,25	4,65	4,45	4,62	4,47	4,48
η <sub>s</sub>	%	163,7	179,4	171,5	178,2	172,3	172,7
<b>DIMENSIONS</b>							
Height	mm	1801	1801	1822	2540	1822	2540
Width	mm	1204	1204	1204	2224	1204	2224
Length	mm	2650	3170	3770	2338	3770	2338
<b>WEIGHT</b>							
Unit Weight (SL Version)	kg	737 (747)	830 (840)	949 (959)	1633 (1736)	1066 (1076)	1663 (1766)
Operating Weight (SL Version)	kg	742 (752)	836 (846)	958 (968)	1644 (1747)	1078 (1088)	1674 (1777)
<b>WATER HEAT EXCHANGER</b>							
Type <sup>(2)</sup>		PHE	PHE	PHE	PHE	PHE	PHE
Water Volume	l	5	6	9	11	12	11
Water flow rate	l/s	4,2	5,4	6,9	8,6	8,7	9,6
Water pressure drop <sup>(4)</sup>	kPa	31,6	37,3	31,1	40,7	45,2	50,1
Insulation material		Closed cell	Closed cell	Closed cell	Closed cell	Closed cell	Closed cell
<b>AIR HEAT EXCHANGER</b>							
Type <sup>(2)</sup>		Mch	Mch	Mch	MCH	Mch	MCH
<b>FAN</b>							
Type <sup>(2)</sup>		DPT	DPT	DPT	DPT	DPT	DPT
Drive <sup>(2)</sup>		Phase cut	Phase cut	Phase cut	On-off	Phase cut	On-off
Diameter	mm	450	450	450	800	450	800
Nominal air flow	l/s	9036	12023	15057	20306	15057	20306
Quantity	No,	6	8	10	4	10	4
Speed	rpm	1360	1360	1360	900	1360	900
Motor input	kW	2,7	3,6	4,5	7,2	4,6	7,2
<b>COMPRESSOR</b>							
Type		Scroll	Scroll	Scroll	Scroll	Scroll	Scroll
Oil charge	l	6,5	7,7	8,9	13,0	10,7	14,1
Quantity	No,	2	2	2	4	2	4
<b>SOUND LEVEL<sup>(3)</sup></b>							
Sound Power - Cooling (SL Version)	dB(A)	86 (85)	89 (87)	91 (89)	91 (91)	92 (89)	92 (91)
Sound Pressure level@1m distance Cooling (SL Version)	dB(A)	68 (68)	71 (69)	72 (70)	72 (72)	74 (71)	73 (72)
<b>REFRIGERANT CIRCUIT</b>							
Refrigerant type		R32	R32	R32	R32	R32	R32
Refrigerant charge	kg	9	10	11	20	12	20
N <sub>r</sub> of circuits	No,	1	1	1	2	1	2
<b>PIPING CONNECTIONS</b>							
Evaporator connections	mm	76,1	76,1	76,1	88,9	76,1	88,9

All the performances (Cooling capacity, unit power input in cooling and EER) are based on the following conditions: evaporator 12,0/7,0°C; ambient 35,0°C, unit at full load operation; operating fluid: Water; fouling factor = 0

(1) In accordance with standard EN14825:2013, comfort low temperature, average climate, SEER and η<sub>s</sub> values applicable Ecodesign regulation: (EU) No 2016/2281

(2) PHE: Plate Heat Exchanger; S&T: Single Pass Shell & Tube; MCH: Microchannel; DPT: Direct Propeller Type; DOL: Direct On Line - VFD: Inverter

(3) Sound power level (referred to evaporator 12/7°C, ambient 35°C full load operation) are measured in accordance with ISO 9614 and Eurovent 8/1 for Eurovent certified units. The certification refers only to the overall sound power level, the sound pressure is calculated from the sound power level and are for information only and not considered binding. The minimum capacity indicated is referred to unit operating at standard Eurovent conditions. Dimensions and weights are for indication only and not considered binding. Before designing the installation, consult the official drawings available from the factory at request. All the data are referred to standard unit without options. All data are subject to change without notice

(4) The value refers to the pressure drops in the evaporator only

(5) Option FANMOD consist in Continuous Fan Speed Regulation and improves part load operation, Single-V units are standardly equipped with continuous fan control, Modular-V units require opt 99- VFD fans

\*Capacity control - Minimum capacity is calculated as the ratio between the minimum horsepower of the smallest compressor respect to the maximum horsepower with all the compressors turned on.

Eurovent certified values

EWAT~B-XS/L

MODEL		EWAT220B -XS(L)B2	EWAT230B -XS(L)B1	EWAT250B -XS(L)B2	EWAT280B -XS(L)B2	EWAT300B -XS(L)B1	EWAT310B -XS(L)B2
<b>COOLING PERFORMANCE</b>							
Capacity - Cooling	kW	226	239	255	282	305	305
Capacity control - Type		Step	Step	Step	Step	Step	Step
Capacity control - Minimum capacity*	%	19	50	17	16	24	14
Unit power input - Cooling	kW	74,7	74,6	81,7	87,9	97,3	97,4
EER		3,03	3,21	3,12	3,20	3,13	3,13
IPLV		4,72	4,60	4,69	4,78	4,86	4,77
IPLV (+opt FANMOD <sup>(5)</sup> )		4,97	5,00	5,02	5,14	4,95	4,93
SEER <sup>(1)</sup>		4,50	4,31	4,47	4,59	4,60	4,60
η <sub>s</sub>	%	173,5	166,0	172,3	177,0	177,4	177,0
SEER (+opt FANMOD <sup>(5)</sup> ) <sup>(1)</sup>		4,68	4,44	4,68	4,79	4,83	4,69
η <sub>s</sub>	%	180,5	171,1	180,5	184,8	186,4	180,9
<b>DIMENSIONS</b>							
Height	mm	2540	2540	2540	2540	2540	2540
Width	mm	2224	2224	2224	2224	2224	2224
Length	mm	2338	3230	3247	3247	3230	3247
<b>WEIGHT</b>							
Unit Weight (SL Version)	kg	1699 (1802)	2014 (2082)	1987 (2090)	2128 (2231)	2226 (2318)	2159 (2262)
Operating Weight (SL Version)	kg	1710 (1813)	2030 (2098)	2001 (2104)	2147 (2250)	2246 (2338)	2178 (2281)
<b>WATER HEAT EXCHANGER</b>							
Type <sup>(2)</sup>		PHE	PHE	PHE	PHE	PHE	PHE
Water Volume	l	11	16	14	19	20	19
Water flow rate	l/s	10,8	11,4	12,2	13,4	14,5	14,6
Water pressure drop <sup>(4)</sup>	kPa	43,7	49,3	54,2	39,9	62,3	46,1
Insulation material		Closed cell	Closed cell	Closed cell	Closed cell	Closed cell	Closed cell
<b>AIR HEAT EXCHANGER</b>							
Type <sup>(2)</sup>		MCH	MCH	MCH	MCH	MCH	MCH
<b>FAN</b>							
Type <sup>(2)</sup>		DPT	DPT	DPT	DPT	DPT	DPT
Drive <sup>(2)</sup>		On-off	On-off	On-off	On-off	On-off	On-off
Diameter	mm	800	800	800	800	800	800
Nominal air flow	l/s	20306	25382	25382	30459	30459	30459
Quantity	No,	4	5	5	6	6	6
Speed	rpm	900	900	900	900	900	900
Motor input	kW	7,2	9,0	9,0	10,8	10,8	10,8
<b>COMPRESSOR</b>							
Type		Scroll	Scroll	Scroll	Scroll	Scroll	Scroll
Oil charge	l	15,3	12,6	16,5	17,2	17,0	18,4
Quantity	No,	4	2	4	4	3	4
<b>SOUND LEVEL <sup>(3)</sup></b>							
Sound Power - Cooling (SL Version)	dB(A)	93 (91)	95 (92)	94 (92)	95 (93)	96 (93)	95 (93)
Sound Pressure level@1m distance Cooling (SL Version)	dB(A)	74 (72)	75 (72)	74 (72)	75 (73)	76 (73)	76 (73)
<b>REFRIGERANT CIRCUIT</b>							
Refrigerant type		R32	R32	R32	R32	R32	R32
Refrigerant charge	kg	20	23,5	24	27,5	28	28
N <sub>r</sub> of circuits	No,	2	1	2	2	1	2
<b>PIPING CONNECTIONS</b>							
Evaporator connections	mm	88,9	76,1	88,9	88,9	76,1	88,9

All the performances (Cooling capacity, unit power input in cooling and EER) are based on the following conditions: evaporator 12,0/7,0°C; ambient 35,0°C, unit at full load operation; operating fluid: Water; fouling factor = 0

(1) In accordance with standard EN14825:2013, comfort low temperature, average climate, SEER and η<sub>s</sub> values applicable Ecodesign regulation: (EU) No 2016/2281

(2) PHE: Plate Heat Exchanger; S&T: Single Pass Shell & Tube; MCH: Microchannel; DPT: Direct Propeller Type; DOL: Direct On Line - VFD: Inverter

(3) Sound power level (referred to evaporator 12/7°C, ambient 35°C full load operation) are measured in accordance with ISO 9614 and Eurovent 8/1 for Eurovent certified units. The certification refers only to the overall sound power level, the sound pressure is calculated from the sound power level and are for information only and not considered binding. The minimum capacity indicated is referred to unit operating at standard Eurovent conditions. Dimensions and weights are for indication only and not considered binding. Before designing the installation, consult the official drawings available from the factory at request. All the data are referred to standard unit without options. All data are subject to change without notice

(4) The value refers to the pressure drops in the evaporator only

(5) Option FANMOD consist in Continuous Fan Speed Regulation and improves part load operation, Single-V units are standardly equipped with continuous fan control, Modular-V units require opt 99- VFD fans

\*Capacity control - Minimum capacity is calculated as the ratio between the minimum horsepower of the smallest compressor respect to the maximum horsepower with all the compressors turned on.

Eurovent certified values

EWAT~B-XS/L

MODEL		EWAT320B -XS(L)B2	EWAT360B -XS(L)B1	EWAT370B -XS(L)B2	EWAT430B -XS(L)B2	EWAT470B -XS(L)B2	EWAT540B -XS(L)B2
<b>COOLING PERFORMANCE</b>							
Capacity - Cooling	kW	326	352	372	425	472	538
Capacity control - Type		Step	Step	Step	Step	Step	Step
Capacity control - Minimum capacity*	%	22	33	19	17	25	14
Unit power input - Cooling	kW	106,8	113,0	121,4	136,7	152,7	175,1
EER		3,06	3,11	3,06	3,11	3,09	3,07
IPLV		4,79	4,38	4,70	4,80	4,90	4,80
IPLV (+opt FANMOD <sup>(5)</sup> )		4,97	4,96	4,95	4,92	4,71	5,05
SEER <sup>(1)</sup>		4,50	4,34	4,48	4,56	4,55	4,56
η <sub>s</sub>	%	173,5	166,8	172,3	175,4	175,4	175,8
SEER (+opt FANMOD <sup>(5)</sup> ) <sup>(1)</sup>		4,53	4,60	4,57	4,64	4,57	4,75
η <sub>s</sub>	%	174,6	177,4	176,2	179,0	176,2	183,3
<b>DIMENSIONS</b>							
Height	mm	2540	2540	2540	2540	2540	2540
Width	mm	2224	2224	2224	2224	2224	2224
Length	mm	3247	4147	4135	4135	5034	5034
<b>WEIGHT</b>							
Unit Weight (SL Version)	kg	2196 (2299)	2639 (2731)	2698 (2801)	2785 (2888)	3228 (3393)	3448 (3633)
Operating Weight (SL Version)	kg	2215 (2318)	2659 (2751)	2718 (2821)	2813 (2916)	3256 (3421)	3490 (3675)
<b>WATER HEAT EXCHANGER</b>							
Type <sup>(2)</sup>		PHE	PHE	PHE	PHE	PHE	PHE
Water Volume	l	19	20	20	28	28	42
Water flow rate	l/s	15,6	16,8	17,7	20,3	22,5	25,7
Water pressure drop <sup>(4)</sup>	kPa	52,0	80,7	65,7	56,7	68,5	59,8
Insulation material		Closed cell	Closed cell	Closed cell	Closed cell	Closed cell	Closed cell
<b>AIR HEAT EXCHANGER</b>							
Type <sup>(2)</sup>		MCH	MCH	MCH	MCH	MCH	MCH
<b>FAN</b>							
Type <sup>(2)</sup>		DPT	DPT	DPT	DPT	DPT	DPT
Drive <sup>(2)</sup>		On-off	On-off	On-off	On-off	On-off	On-off
Diameter	mm	800	800	800	800	800	800
Nominal air flow	l/s	30459	35535	35535	40612	45688	50765
Quantity	No,	6	7	7	8	9	10
Speed	rpm	900	900	900	900	900	900
Motor input	kW	10,8	12,6	12,6	14,3	16,1	17,9
<b>COMPRESSOR</b>							
Type		Scroll	Scroll	Scroll	Scroll	Scroll	Scroll
Oil charge	l	19,6	18,9	21,4	23,3	25,2	29,6
Quantity	No,	4	3	4	4	4	5
<b>SOUND LEVEL<sup>(3)</sup></b>							
Sound Power - Cooling (SL Version)	dB(A)	95 (93)	96 (93)	96 (93)	97 (94)	98 (94)	98 (95)
Sound Pressure level@1m distance Cooling (SL Version)	dB(A)	76 (73)	76 (73)	76 (73)	77 (74)	77 (74)	78 (74)
<b>REFRIGERANT CIRCUIT</b>							
Refrigerant type		R32	R32	R32	R32	R32	R32
Refrigerant charge	kg	27,5	32	31	36	43,5	49
N <sub>r</sub> of circuits	No,	2	1	2	2	2	2
<b>PIPING CONNECTIONS</b>							
Evaporator connections	mm	88,9	76,1	88,9	88,9	88,9	114,3

All the performances (Cooling capacity, unit power input in cooling and EER) are based on the following conditions: evaporator 12,0/7,0°C; ambient 35,0°C, unit at full load operation; operating fluid: Water; fouling factor = 0

(1) In accordance with standard EN14825:2013, comfort low temperature, average climate, SEER and η<sub>s</sub> values applicable Ecodesign regulation: (EU) No 2016/2281

(2) PHE: Plate Heat Exchanger; S&T: Single Pass Shell & Tube; MCH: Microchannel; DPT: Direct Propeller Type; DOL: Direct On Line - VFD: Inverter

(3) Sound power level (referred to evaporator 12/7°C, ambient 35°C full load operation) are measured in accordance with ISO 9614 and Eurovent 8/1 for Eurovent certified units. The certification refers only to the overall sound power level, the sound pressure is calculated from the sound power level and are for information only and not considered binding. The minimum capacity indicated is referred to unit operating at standard Eurovent conditions. Dimensions and weights are for indication only and not considered binding. Before designing the installation, consult the official drawings available from the factory at request. All the data are referred to standard unit without options. All data are subject to change without notice

(4) The value refers to the pressure drops in the evaporator only

(5) Option FANMOD consist in Continuous Fan Speed Regulation and improves part load operation, Single-V units are standardly equipped with continuous fan control, Modular-V units require opt 99- VFD fans

\*Capacity control - Minimum capacity is calculated as the ratio between the minimum horsepower of the smallest compressor respect to the maximum horsepower with all the compressors turned on.

Eurovent certified values

**EWAT~B-XS/L**

MODEL		EWAT600B -XS(L)B2	EWAT660B -XS(L)B2	EWAT700B -XS(L)B2
<b>COOLING PERFORMANCE</b>				
Capacity - Cooling	kW	609	662	704
Capacity control - Type		Step	Step	Step
Capacity control - Minimum capacity*	%	12	11	17
Unit power input - Cooling	kW	195,1	211,1	227,1
EER		3,12	3,14	3,10
IPLV		4,79	4,82	4,77
IPLV (+opt FANMOD <sup>(5)</sup> )		5,08	5,12	5,1
SEER <sup>(1)</sup>		4,61	4,64	4,58
$\eta_s$	%	177,8	179,0	176,6
SEER (+opt FANMOD <sup>(5)</sup> ) <sup>(1)</sup>		4,75	4,84	4,84
$\eta_s$	%	183,3	186,8	186,8
<b>DIMENSIONS</b>				
Height	mm	2540	2540	2540
Width	mm	2224	2224	2224
Length	mm	5888	6795	6795
<b>WEIGHT</b>				
Unit Weight (SL Version)	kg	3900 (4106)	4294 (4500)	4436 (4642)
Operating Weight (SL Version)	kg	3942 (4148)	4344 (4550)	4486 (4692)
<b>WATER HEAT EXCHANGER</b>				
Type <sup>(2)</sup>		PHE	PHE	PHE
Water Volume	l	42	50	50
Water flow rate	l/s	29,1	31,6	33,6
Water pressure drop <sup>(4)</sup>	kPa	74,6	70,3	78,5
Insulation material		Closed cell	Closed cell	Closed cell
<b>AIR HEAT EXCHANGER</b>				
Type <sup>(2)</sup>		MCH	MCH	MCH
<b>FAN</b>				
Type <sup>(2)</sup>		DPT	DPT	DPT
Drive <sup>(2)</sup>		On-off	On-off	On-off
Diameter	mm	800	800	800
Nominal air flow	l/s	60918	65994	71071
Quantity	No,	12	13	14
Speed	rpm	900	900	900
Motor input	kW	21,5	23,3	25,1
<b>COMPRESSOR</b>				
Type		Scroll	Scroll	Scroll
Oil charge	l	34,0	35,9	37,8
Quantity	No,	6	6	6
<b>SOUND LEVEL<sup>(3)</sup></b>				
Sound Power - Cooling (SL Version)	dB(A)	99 (96)	99 (96)	99 (96)
Sound Pressure level@1m distance Cooling (SL Version)	dB(A)	78 (75)	78 (75)	78 (75)
<b>REFRIGERANT CIRCUIT</b>				
Refrigerant type		R32	R32	R32
Refrigerant charge	kg	55	60	66
N, of circuits	No,	2	2	2
<b>PIPING CONNECTIONS</b>				
Evaporator connections	mm	114,3	114,3	114,3

All the performances (Cooling capacity, unit power input in cooling and EER) are based on the following conditions: evaporator 12,0/7,0°C; ambient 35,0°C, unit at full load operation; operating fluid: Water; fouling factor = 0

(1) In accordance with standard EN14825:2013, comfort low temperature, average climate, SEER and  $\mu_s$  values applicable Ecodesign regulation: (EU) No 2016/2281

(2) PHE: Plate Heat Exchanger; S&T: Single Pass Shell & Tube; MCH: Microchannel; DPT: Direct Propeller Type; DOL: Direct On Line - VFD: Inverter

(3) Sound power level (referred to evaporator 12/7°C, ambient 35°C full load operation) are measured in accordance with ISO 9614 and Eurovent 8/1 for Eurovent certified units. The certification refers only to the overall sound power level, the sound pressure is calculated from the sound power level and are for information only and not considered binding. The minimum capacity indicated is referred to unit operating at standard Eurovent conditions. Dimensions and weights are for indication only and not considered binding. Before designing the installation, consult the official drawings available from the factory at request. All the data are referred to standard unit without options. All data are subject to change without notice

(4) The value refers to the pressure drops in the evaporator only

(5) Option FANMOD consist in Continuous Fan Speed Regulation and improves part load operation, Single-V units are standardly equipped with continuous fan control, Modular-V units require opt 99- VFD fans

\*Capacity control - Minimum capacity is calculated as the ratio between the minimum horsepower of the smallest compressor respect to the maximum horsepower with all the compressors turned on.

Eurovent certified values

EWAT~B-XR

MODEL		EWAT085B -XR1	EWAT115B -XR1	EWAT145B -XR1	EWAT180B -XR2	EWAT185B -XR1	EWAT200B -XR2
<b>COOLING PERFORMANCE</b>							
Capacity - Cooling	kW	82	109	136	168	166	188
Capacity control - Type		Step	Step	Step	Step	Step	Step
Capacity control - Minimum capacity*	%	50	38	50	25	38	21
Unit power input - Cooling	kW	30,8	38,9	46,9	59,1	70,5	69,8
EER		2,66	2,79	2,89	2,84	2,36	2,69
IPLV (+opt FANMOD <sup>(5)</sup> )		4,74	4,91	4,70	5,04	4,72	5,05
SEER (+opt FANMOD <sup>(5)</sup> ) <sup>(1)</sup>		4,13	4,56	4,24	4,50	4,19	4,74
$\eta_s$	%	150,6	166,6	160,2	163,8	160,2	166,6
<b>DIMENSIONS</b>							
Height	mm	1801	1801	1822	2540	1822	2540
Width	mm	1204	1204	1204	2224	1204	2224
Length	mm	2650	3170	3770	2338	3770	2338
<b>WEIGHT</b>							
Unit Weight	kg	747	840	959	1736	1076	1776
Operating Weight	kg	752	846	968	1747	1088	1777
<b>WATER HEAT EXCHANGER</b>							
Type <sup>(2)</sup>		PHE	PHE	PHE	PHE	PHE	PHE
Water Volume	l	5	6	9	11	12	11
Water flow rate	l/s	3,9	5,2	6,5	8,0	7,9	9,0
Water pressure drop <sup>(4)</sup>	kPa	27,8	34,2	28,1	36,4	38,1	44,3
Insulation material		Closed cell	Closed cell	Closed cell	Closed cell	Closed cell	Closed cell
<b>AIR HEAT EXCHANGER</b>							
Type <sup>(2)</sup>		Mch	Mch	Mch	Mch	Mch	Mch
<b>FAN</b>							
Type <sup>(2)</sup>		DPT	DPT	DPT	DPT	DPT	DPT
Drive <sup>(2)</sup>		Phase cut	Phase cut	Phase cut	VFD fans	Phase cut	VFD fans
Diameter	mm	450	450	450	800	450	800
Nominal air flow	l/s	6673	8896	11122	15054	11122	15054
Quantity	No,	6	8	10	4	10	4
Speed	rpm	1108	1108	1108	700	1108	700
Motor input	kW	2,1	2,8	3,5	3,6	3,5	3,6
<b>COMPRESSOR</b>							
Type		Scroll	Scroll	Scroll	Scroll	Scroll	Scroll
Oil charge	l	6,5	7,7	8,9	13,0	10,7	14,1
Quantity	No,	2	2	2	4	2	4
<b>SOUND LEVEL<sup>(3)</sup></b>							
Sound Power - Cooling	dB(A)	78	82	84	84	86	85
Sound Pressure level@1m distance Cooling	dB(A)	60	64	66	65	68	66
<b>REFRIGERANT CIRCUIT</b>							
Refrigerant type		R32	R32	R32	R32	R32	R32
Refrigerant charge	kg	9	10	11	12	20	20
N <sub>r</sub> of circuits	No,	1	1	1	2	1	2
<b>PIPING CONNECTIONS</b>							
Evaporator water inlet/outlet	mm	76,1	76,1	76,1	88,9	76,1	88,9

All the performances (Cooling capacity, unit power input in cooling and EER) are based on the following conditions: evaporator 12,0/7,0°C; ambient 35,0°C, unit at full load operation; operating fluid: Water; fouling factor = 0

(1) In accordance with standard EN14825:2013, comfort low temperature, average climate, SEER and  $\mu_s$  values applicable Ecodesign regulation: (EU) No 2016/2281

(2) PHE: Plate Heat Exchanger; S&T: Single Pass Shell & Tube; MCH: Microchannel; DPT: Direct Propeller Type; DOL: Direct On Line - VFD: Inverter

(3) Sound power level (referred to evaporator 12/7°C, ambient 35°C full load operation) are measured in accordance with ISO 9614 and Eurovent 8/1 for Eurovent certified units. The certification refers only to the overall sound power level, the sound pressure is calculated from the sound power level and are for information only and not considered binding. The minimum capacity indicated is referred to unit operating at standard Eurovent conditions. Dimensions and weights are for indication only and not considered binding. Before designing the installation, consult the official drawings available from the factory at request. All the data are referred to standard unit without options. All data are subject to change without notice

(4) The value refers to the pressure drops in the evaporator only

(5) Option FANMOD consist in Continuous Fan Speed Regulation and improves part load operation, Single-V units are standardly equipped with continuous fan control, Modular-V units require opt 99- VFD fans

\*Capacity control - Minimum capacity is calculated as the ratio between the minimum horsepower of the smallest compressor respect to the maximum horsepower with all the compressors turned on.

**EWAT~B-XR**

MODEL		EWAT220B -XR2	EWAT230B -XR1	EWAT250B -XR2	EWAT280B -XR2	EWAT300B -XR1	EWAT310B -XR2
<b>COOLING PERFORMANCE</b>							
Capacity - Cooling	kW	208	225	238	265	285	285
Capacity control - Type		Step	Step	Step	Step	Step	Step
Capacity control - Minimum capacity*	%	19	50	17	16	24	14
Unit power input - Cooling	kW	80,7	79,2	87,3	92,2	104,8	103,0
EER		2,58	2,84	2,73	2,87	2,72	2,76
IPLV (+opt FANMOD <sup>(5)</sup> )		4,97	4,86	4,91	5,08	4,78	4,94
SEER (+opt FANMOD <sup>(5)</sup> ) <sup>(1)</sup>		4,55	4,30	4,50	4,74	4,72	4,65
$\eta_s$	%	166,6	165,0	171,4	176,6	180,6	174,6
<b>DIMENSIONS</b>							
Height	mm	2540	2540	2540	2540	2540	2540
Width	mm	2224	2224	2224	2224	2224	2224
Length	mm	2338	3230	3247	3247	3230	3247
<b>WEIGHT</b>							
Unit Weight	kg	1802	2082	2090	2231	2318	2262
Operating Weight	kg	1813	2098	2104	2250	2338	2281
<b>WATER HEAT EXCHANGER</b>							
Type <sup>(2)</sup>		PHE	PHE	PHE	PHE	PHE	PHE
Water Volume	l	11	16	14	19	20	19
Water flow rate	l/s	10,0	10,7	11,4	12,6	13,6	13,6
Water pressure drop <sup>(4)</sup>	kPa	37,7	44,0	48,2	35,7	55,2	40,7
Insulation material		Closed cell	Closed cell	Closed cell	Closed cell	Closed cell	Closed cell
<b>AIR HEAT EXCHANGER</b>							
Type <sup>(2)</sup>		Mch	Mch	Mch	Mch	Mch	Mch
<b>FAN</b>							
Type <sup>(2)</sup>		DPT	DPT	DPT	DPT	DPT	DPT
Drive <sup>(2)</sup>		VFD fans	VFD fans	VFD fans	VFD fans	VFD fans	VFD fans
Diameter	mm	800	800	800	800	800	800
Nominal air flow	l/s	15054	18819	18818	22582	22582	22582
Quantity	No,	4	5	5	6	6	6
Speed	rpm	700	700	700	700	700	700
Motor input	kW	3,6	4,4	4,4	5,3	5,3	5,3
<b>COMPRESSOR</b>							
Type		Scroll	Scroll	Scroll	Scroll	Scroll	Scroll
Oil charge	l	15,3	12,6	16,5	17,2	17,0	18,4
Quantity	No,	4	2	4	4	3	4
<b>SOUND LEVEL <sup>(3)</sup></b>							
Sound Power - Cooling	dB(A)	85	86	86	87	87	87
Sound Pressure level@1m distance Cooling	dB(A)	66	67	66	67	68	67
<b>REFRIGERANT CIRCUIT</b>							
Refrigerant type		R32	R32	R32	R32	R32	R32
Refrigerant charge	kg	20	23,5	24	27,5	28	28
N, of circuits	No,	2	1	2	2	1	2
<b>PIPING CONNECTIONS</b>							
Evaporator water inlet/outlet	mm	88,9	76,1	88,9	88,9	76,1	88,9

All the performances (Cooling capacity, unit power input in cooling and EER) are based on the following conditions: evaporator 12,0/7,0°C; ambient 35,0°C, unit at full load operation; operating fluid: Water; fouling factor = 0

(1) In accordance with standard EN14825:2013, comfort low temperature, average climate, SEER and  $\mu_s$  values applicable Ecodesign regulation: (EU) No 2016/2281

(2) PHE: Plate Heat Exchanger; S&T: Single Pass Shell & Tube; MCH: Microchannel; DPT: Direct Propeller Type; DOL: Direct On Line - VFD: Inverter

(3) Sound power level (referred to evaporator 12/7°C, ambient 35°C full load operation) are measured in accordance with ISO 9614 and Eurovent 8/1 for Eurovent certified units. The certification refers only to the overall sound power level, the sound pressure is calculated from the sound power level and are for information only and not considered binding. The minimum capacity indicated is referred to unit operating at standard Eurovent conditions. Dimensions and weights are for indication only and not considered binding. Before designing the installation, consult the official drawings available from the factory at request. All the data are referred to standard unit without options. All data are subject to change without notice

(4) The value refers to the pressure drops in the evaporator only

(5) Option FANMOD consist in Continuous Fan Speed Regulation and improves part load operation, Single-V units are standardly equipped with continuous fan control, Modular-V units require opt 99- VFD fans

\*Capacity control - Minimum capacity is calculated as the ratio between the minimum horsepower of the smallest compressor respect to the maximum horsepower with all the compressors turned on.



**EWAT~B-XR**

MODEL		EWAT320B -XR2	EWAT360B -XR1	EWAT370B -XR2	EWAT430B -XR2	EWAT470B -XR2	EWAT540B -XR2
<b>COOLING PERFORMANCE</b>							
Capacity - Cooling	kW	302	329	346	394	440	502
Capacity control - Type		Step	Step	Step	Step	Step	Step
Capacity control - Minimum capacity*	%	22	33	19	17	25	14
Unit power input - Cooling	kW	115,0	121,0	129,8	146,6	163,0	189,8
EER		2,63	2,71	2,67	2,69	2,69	2,64
IPLV (+opt FANMOD <sup>(5)</sup> )		4,62	5,04	4,95	4,88	4,72	4,96
SEER (+opt FANMOD <sup>(5)</sup> ) <sup>(1)</sup>		4,42	4,59	4,48	4,62	4,55	4,65
$\eta_s$	%	166,6	175,0	169,8	175,8	167,4	178,6
<b>DIMENSIONS</b>							
Height	mm	2540	2540	2540	2540	2540	2540
Width	mm	2224	2224	2224	2224	2224	2224
Length	mm	3247	4147	4135	4135	5034	5034
<b>WEIGHT</b>							
Unit Weight	kg	2299	2731	2801	2888	3393	3633
Operating Weight	kg	2318	2751	2821	2916	3421	3675
<b>WATER HEAT EXCHANGER</b>							
Type <sup>(2)</sup>		PHE	PHE	PHE	PHE	PHE	PHE
Water Volume	l	19	20	20	28	28	42
Water flow rate	l/s	14,4	15,7	16,5	18,8	21,0	23,9
Water pressure drop <sup>(4)</sup>	kPa	45,2	71,5	57,9	49,5	60,2	52,6
Insulation material		Closed cell	Closed cell	Closed cell	Closed cell	Closed cell	Closed cell
<b>AIR HEAT EXCHANGER</b>							
Type <sup>(2)</sup>		Mch	Mch	Mch	Mch	Mch	Mch
<b>FAN</b>							
Type <sup>(2)</sup>		DPT	DPT	DPT	DPT	DPT	DPT
Drive <sup>(2)</sup>		VFD fans	VFD fans	VFD fans	VFD fans	VFD fans	VFD fans
Diameter	mm	800	800	800	800	800	800
Nominal air flow	l/s	22582	26346	26346	30110	33874	37637
Quantity	No,	6	7	7	8	9	10
Speed	rpm	700	700	700	700	700	700
Motor input	kW	5,3	6,2	6,2	7,1	8,0	8,9
<b>COMPRESSOR</b>							
Type		Scroll	Scroll	Scroll	Scroll	Scroll	Scroll
Oil charge	l	19,6	18,9	21,4	23,3	25,2	29,6
Quantity	No,	4	3	4	4	4	5
<b>SOUND LEVEL<sup>(3)</sup></b>							
Sound Power - Cooling	dB(A)	87	88	88	88	89	90
Sound Pressure level@1m distance Cooling	dB(A)	67	68	68	68	69	69
<b>REFRIGERANT CIRCUIT</b>							
Refrigerant type		R32	R32	R32	R32	R32	R32
Refrigerant charge	kg	27,5	32	31	36	43,5	49
N, of circuits	No,	2	1	2	2	2	2
<b>PIPING CONNECTIONS</b>							
Evaporator water inlet/outlet	mm	88,9	76,1	88,9	88,9	88,9	114,3

All the performances (Cooling capacity, unit power input in cooling and EER) are based on the following conditions: evaporator 12,0/7,0°C; ambient 35,0°C, unit at full load operation; operating fluid: Water; fouling factor = 0

(1) In accordance with standard EN14825:2013, comfort low temperature, average climate, SEER and  $\mu_s$  values applicable Ecodesign regulation: (EU) No 2016/2281

(2) PHE: Plate Heat Exchanger; S&T: Single Pass Shell & Tube; MCH: Microchannel; DPT: Direct Propeller Type; DOL: Direct On Line - VFD: Inverter

(3) Sound power level (referred to evaporator 12/7°C, ambient 35°C full load operation) are measured in accordance with ISO 9614 and Eurovent 8/1 for Eurovent certified units. The certification refers only to the overall sound power level, the sound pressure is calculated from the sound power level and are for information only and not considered binding. The minimum capacity indicated is referred to unit operating at standard Eurovent conditions. Dimensions and weights are for indication only and not considered binding. Before designing the installation, consult the official drawings available from the factory at request. All the data are referred to standard unit without options. All data are subject to change without notice

(4) The value refers to the pressure drops in the evaporator only

(5) Option FANMOD consist in Continuous Fan Speed Regulation and improves part load operation, Single-V units are standardly equipped with continuous fan control, Modular-V units require opt 99- VFD fans

\*Capacity control - Minimum capacity is calculated as the ratio between the minimum horsepower of the smallest compressor respect to the maximum horsepower with all the compressors turned on.

**EWAT~B-XR**

MODEL		EWAT600B -XRB2	EWAT660B -XRB2	EWAT700B -XRB2
<b>COOLING PERFORMANCE</b>				
Capacity - Cooling	kW	572	621	659
Capacity control - Type		Step	Step	Step
Capacity control - Minimum capacity*	%	12	11	17
Unit power input - Cooling	kW	207,0	224,0	242,0
EER		2,76	2,77	2,72
IPLV (+opt FANMOD <sup>(5)</sup> )		5,04	5,07	5,08
SEER (+opt FANMOD <sup>(5)</sup> ) <sup>(1)</sup>		4,76	4,76	4,71
$\eta_s$	%	181,4	181,0	180,2
<b>DIMENSIONS</b>				
Height	mm	2540	2540	2540
Width	mm	2224	2224	2224
Length	mm	5888	6795	6795
<b>WEIGHT</b>				
Unit Weight	kg	4106	4500	4642
Operating Weight	kg	4148	4550	4692
<b>WATER HEAT EXCHANGER</b>				
Type <sup>(2)</sup>		PHE	PHE	PHE
Water Volume	l	42	50	50
Water flow rate	l/s	27,3	29,6	31,5
Water pressure drop <sup>(4)</sup>	kPa	66,6	62,6	69,7
Insulation material		Closed cell	Closed cell	Closed cell
<b>AIR HEAT EXCHANGER</b>				
Type <sup>(2)</sup>		Mch	Mch	Mch
<b>FAN</b>				
Type <sup>(2)</sup>		DPT	DPT	DPT
Drive <sup>(2)</sup>		VFD fans	VFD fans	VFD fans
Diameter	mm	800	800	800
Nominal air flow	l/s	45164	48928	52692
Quantity	No,	12	13	14
Speed	rpm	700	700	700
Motor input	kW	10,6	11,5	12,4
<b>COMPRESSOR</b>				
Type		Scroll	Scroll	Scroll
Oil charge	l	34,0	35,9	37,8
Quantity	No,	6	6	6
<b>SOUND LEVEL <sup>(3)</sup></b>				
Sound Power - Cooling	dB(A)	90	90	91
Sound Pressure level@1m distance Cooling	dB(A)	69	69	70
<b>REFRIGERANT CIRCUIT</b>				
Refrigerant type		R32	R32	R32
Refrigerant charge	kg	55	60	66
N, of circuits	No,	2	2	2
<b>PIPING CONNECTIONS</b>				
Evaporator water inlet/outlet	mm	114,3	114,3	114,3

All the performances (Cooling capacity, unit power input in cooling and EER) are based on the following conditions: evaporator 12,0/7,0°C; ambient 35,0°C, unit at full load operation; operating fluid: Water; fouling factor = 0

(1) In accordance with standard EN14825:2013, comfort low temperature, average climate, SEER and  $\mu_s$  values applicable Ecodesign regulation: (EU) No 2016/2281

(2) PHE: Plate Heat Exchanger; S&T: Single Pass Shell & Tube; MCH: Microchannel; DPT: Direct Propeller Type; DOL: Direct On Line - VFD: Inverter

(3) Sound power level (referred to evaporator 12/7°C, ambient 35°C full load operation) are measured in accordance with ISO 9614 and Eurovent 8/1 for Eurovent certified units. The certification refers only to the overall sound power level, the sound pressure is calculated from the sound power level and are for information only and not considered binding. The minimum capacity indicated is referred to unit operating at standard Eurovent conditions. Dimensions and weights are for indication only and not considered binding. Before designing the installation, consult the official drawings available from the factory at request. All the data are referred to standard unit without options. All data are subject to change without notice

(4) The value refers to the pressure drops in the evaporator only

(5) Option FANMOD consist in Continuous Fan Speed Regulation and improves part load operation, Single-V units are standardly equipped with continuous fan control, Modular-V units require opt 99- VFD fans

\*Capacity control - Minimum capacity is calculated as the ratio between the minimum horsepower of the smallest compressor respect to the maximum horsepower with all the compressors turned on.

Eurovent certified values

FREE COOLING PERFORMANCES AND TECHNICAL DATA

EWAT~B-SS(L)

MODEL		EWAT240B-SS(L)B2	EWAT260B-SS(L)B2	EWAT290B-SS(L)B1	EWAT310B-SS(L)B2	EWAT330B-SS(L)B2
<b>FULL FREE COOLING PERFORMANCE</b>						
Capacity - Cooling	kW	130,1	130,1	130,1	162,6	162,6
Unit power input - Cooling	kW	5,67	5,67	5,67	7,09	7,09
EER		22,9	22,9	22,9	22,9	22,9
Water pressure drop	kPa	34,5	40,2	67,8	44,6	51,5
<b>LIGHT FREE COOLING PERFORMANCE</b>						
Capacity - Cooling	kW	31,96	31,96	45,65	57,06	57,06
Unit power input - Cooling	kW	1,71	1,71	1,71	2,14	2,14
EER		18,7	18,7	26,7	26,7	26,7
Water pressure drop	kPa	59,5	68,1	56,6	39,6	45
<b>DIMENSIONS</b>						
Height	mm	2540	2540	2540	2540	2540
Width	mm	2224	2224	2224	2224	2224
Length - Full Free Cooling	mm	3600	3600	3614	3621	3621
MODEL		EWAT340B-SS(L)B1	EWAT350B-S(L)B2	EWAT420B-S(L)B2	EWAT460B-S(L)B2	EWAT510B-S(L)B2
<b>FULL FREE COOLING PERFORMANCE</b>						
Capacity - Cooling	kW	195,1	162,6	227,7	227,7	260,2
Unit power input - Cooling	kW	8,51	7,09	9,93	9,93	11,4
EER		22,9	22,9	22,9	22,9	22,9
Water pressure drop	kPa	34,3	58	48,8	61,5	56,1
<b>LIGHT FREE COOLING PERFORMANCE</b>						
Capacity - Cooling	kW	68,48	57,06	79,89	79,89	91,3
Unit power input - Cooling	kW	2,56	2,14	2,99	2,99	3,42
EER		26,7	26,7	26,7	26,7	26,7
Water pressure drop	kPa	65,7	50,2	46,5	57,3	67,8
<b>DIMENSIONS</b>						
Height	mm	2540	2540	2540	2540	2540
Width	mm	2224	2224	2224	2224	2224
Length - Full Free Cooling	mm	3614	3621	4225	4515	4515

MODEL		EWAT570B-S(L)B2	EWAT610B-S(L)B2	EWAT670B-S(L)B2
<b>FULL FREE COOLING PERFORMANCE</b>				
Capacity - Cooling	kW	260,2	292,7	357,7
Unit power input - Cooling	kW	11,4	12,8	15,6
EER		22,9	22,9	22,9
Water pressure drop	kPa	68,1	43,2	32,4
<b>LIGHT FREE COOLING PERFORMANCE</b>				
Capacity - Cooling	kW	91,3	102,7	125,5
Unit power input - Cooling	kW	3,42	3,84	4,7
EER		26,7	26,7	26,7
Water pressure drop	kPa	55,6	63,9	74,9
<b>DIMENSIONS</b>				
Height	mm	2540	2540	2540
Width	mm	2224	2224	2224
Length - Full Free Cooling	mm	4688	5190	5888

*\*All the performances (Cooling capacity, unit power input and EER) are based on the following conditions: evaporator water conditions 16,0/10,0°C; outdoor ambient temperature 0°C, fouling factor = 0. Dimensions and weights are for indication only and not considered binding. Before designing the installation, consult the official drawings available from the factory at request. All the data are referred to standard unit without options. All data are subject to change without notice.*

**EWAT~B-SR**

MODEL		EWAT240B-SRB2	EWAT260B-SRB2	EWAT290B-SRB1	EWAT310B-SRB2	EWAT330B-SRB2
<b>FULL FREE COOLING PERFORMANCE</b>						
Capacity - Cooling	kW	130,2	130,2	130,2	162,8	162,8
Unit power input - Cooling	kW	5,84	5,84	5,84	7,3	7,3
EER		22,3	22,3	22,3	22,3	22,3
Water pressure drop	kPa	31,6	36,5	60	39,8	45,9
<b>LIGHT FREE COOLING PERFORMANCE</b>						
Capacity - Cooling	kW	31,95	31,95	45,65	57,06	57,06
Unit power input - Cooling	kW	1,52	1,52	1,52	1,89	1,89
EER		21,1	21,1	30,1	30,1	30,1
Water pressure drop	kPa	54,9	62,5	50,7	35,8	40,6
<b>DIMENSIONS</b>						
Height	mm	2540	2540	2540	2540	2540
Width	mm	2224	2224	2224	2224	2224
Length - Full Free Cooling	mm	3600	3600	3614	3621	3621

## TECHNICAL SPECIFICATION

MODEL		EWAT340B-SRB1	EWAT350B-SR	EWAT420B-SRB2	EWAT460B-SRB2	EWAT510B-SRB2
<b>FULL FREE COOLING PERFORMANCE</b>						
Capacity - Cooling	kW	195,3	162,8	227,9	227,9	260,4
Unit power input - Cooling	kW	8,76	7,3	10,2	10,2	11,7
EER		22,3	22,3	22,3	22,3	22,3
Water pressure drop	kPa	31,4	51,7	45,5	55,1	50,5
<b>LIGHT FREE COOLING PERFORMANCE</b>						
Capacity - Cooling	kW	68,47	57,06	79,89	79,89	91,3
Unit power input - Cooling	kW	2,27	1,89	2,65	2,65	3,03
EER		30,1	30,1	30,1	30,1	30,1
Water pressure drop	kPa	60,8	45,2	42,9	51,9	61,7
<b>DIMENSIONS</b>						
Height	mm	2540	2540	2540	2540	2540
Width	mm	2224	2224	2224	2224	2224
Length - Full Free Cooling	mm	3614	3621	4225	4515	4515
MODEL		EWAT570B-SRB2	EWAT610B-SRB2	EWAT670B-SRB2		
<b>FULL FREE COOLING PERFORMANCE</b>						
Capacity - Cooling	kW	260,4	293	358,1		
Unit power input - Cooling	kW	11,7	13,2	16,1		
EER		22,3	22,3	22,3		
Water pressure drop	kPa	60,4	38,6	29,5		
<b>LIGHT FREE COOLING PERFORMANCE</b>						
Capacity - Cooling	kW	91,3	102,7	125,5		
Unit power input - Cooling	kW	3,03	3,41	4,17		
EER		30,1	30,1	30,1		
Water pressure drop	kPa	49,9	57,6	68,8		
<b>DIMENSIONS</b>						
Height	mm	2540	2540	2540		
Width	mm	2224	2224	2224		
Length - Full Free Cooling/Light Free Cooling	mm	4688	5190	5888		

*\*All the performances (Cooling capacity, unit power input and EER) are based on the following conditions: evaporator 16,0/10,0°C; ambient 0°C, fouling factor = 0. Dimensions and weights are for indication only and not considered binding. Before designing the installation, consult the official drawings available from the factory at request. All the data are referred to standard unit without options. All data are subject to change without notice.*

**EWAT~B-XS(L)**

MODEL		EWAT180B-XS(L)B2	EWAT200B-XS(L)B2	EWAT220B-XS(L)B2	EWAT230B-XS(L)B1	EWAT250B-XS(L)B2
<b>FULL FREE COOLING PERFORMANCE</b>						
Capacity - Cooling	kW	130,1	130,1	130,1	162,6	162,6
Unit power input - Cooling	kW	5,67	5,67	5,67	7,09	7,09
EER		22,9	22,9	22,9	22,9	22,9
Water pressure drop	kPa	19,1	24	30,4	16,6	31
<b>LIGHT FREE COOLING PERFORMANCE</b>						
Capacity - Cooling	kW	31,96	31,96	31,96	57,06	39,95
Unit power input - Cooling	kW	1,71	1,71	1,71	2,14	2,14
EER		18,7	18,7	18,7	26,7	18,7
Water pressure drop	kPa	34,9	42,9	37,4	42	46,3
<b>DIMENSIONS</b>						
Height	mm	2540	2540	2540	2540	2540
Width	mm	2224	2224	2224	2224	2224
Length - Full Free Cooling	mm	3600	3600	3600	3614	3621

MODEL		EWAT280B-XS(L)B2	EWAT300B-XS(L)B1	EWAT310B-XS(L)B2	EWAT320B-XS(L)B2	EWAT360B-XS(L)B1
<b>FULL FREE COOLING PERFORMANCE</b>						
Capacity - Cooling	kW	195,1	195,1	195,1	195,1	215,8
Unit power input - Cooling	kW	8,51	8,51	8,51	8,51	9,93
EER		22,9	22,9	22,9	22,9	21,7
Water pressure drop	kPa	26,5	27	31,1	35,5	26
<b>LIGHT FREE COOLING PERFORMANCE</b>						
Capacity - Cooling	kW	68,48	68,48	68,48	68,48	79,89
Unit power input - Cooling	kW	2,56	2,56	2,56	2,56	2,99
EER		26,7	26,7	26,7	26,7	26,7
Water pressure drop	kPa	34,2	53,1	39,4	44,4	68,7
<b>DIMENSIONS</b>						
Height	mm	2540	2540	2540	2540	2540
Width	mm	2224	2224	2224	2224	2224
Length - Full Free Cooling	mm	3621	3614	3621	3621	4147

MODEL		EWAT370B- XS(L)B2	EWAT430B- XS(L)B2	EWAT470B- XS(L)B2	EWAT540B- XS(L)B2	EWAT600B- XS(L)B2
<b>FULL FREE COOLING PERFORMANCE</b>						
Capacity - Cooling	kW	227,7	260,2	292,7	325,2	390,3
Unit power input - Cooling	kW	9,93	11,4	12,8	14,2	17
EER		22,9	22,9	22,9	22,9	22,9
Water pressure drop	kPa	39	38,6	25,9	33,6	27
<b>LIGHT FREE COOLING PERFORMANCE</b>						
Capacity - Cooling	kW	79,89	91,3	102,7	114,1	137
Unit power input - Cooling	kW	2,99	3,42	3,84	4,27	5,13
EER		26,7	26,7	26,7	26,7	26,7
Water pressure drop	kPa	56,1	48,4	58,5	50,9	63,7
<b>DIMENSIONS</b>						
Height	mm	2540	2540	2540	2540	2540
Width	mm	2224	2224	2224	2224	2224
Length - Full Free Cooling	mm	4225	4225	5190	5190	5888
MODEL		EWAT660B- XS(L)B2	EWAT700B- XS(L)B2			
<b>FULL FREE COOLING PERFORMANCE</b>						
Capacity - Cooling	kW	410,9	422,2			
Unit power input - Cooling	kW	18,4	19,9			
EER		22,3	21,3			
Water pressure drop	kPa	27	30,5			
<b>LIGHT FREE COOLING PERFORMANCE</b>						
Capacity - Cooling	kW	148,4	159,8			
Unit power input - Cooling	kW	5,55	5,98			
EER		26,7	26,7			
Water pressure drop	kPa	60	67			
<b>DIMENSIONS</b>						
Height	mm	2540	2540			
Width	mm	2224	2224			
Length - Full Free Cooling	mm	6788	6788			

\*All the performances (Cooling capacity, unit power input and EER) are based on the following conditions: evaporator 16,0/10,0°C; ambient 0°C, fouling factor = 0. Dimensions and weights are for indication only and not considered binding. Before designing the installation, consult the official drawings available from the factory at request. All the data are referred to standard unit without options. All data are subject to change without notice.

EWAT~B-XR

MODEL		EWAT180B-XRB2	EWAT200B-XRB2	EWAT220B-XRB2	EWAT230B-XRB1	EWAT250B-XRB2
<b>FULL FREE COOLING PERFORMANCE</b>						
Capacity - Cooling	kW	130,4	130,4	130,4	163	163
Unit power input - Cooling	kW	6,29	6,29	6,29	7,86	7,86
EER		20,7	20,7	20,7	20,7	20,7
Water pressure drop	kPa	16,8	20,9	25,7	14,6	27,1
<b>LIGHT FREE COOLING PERFORMANCE</b>						
Capacity - Cooling	kW	31,96	31,96	31,96	57,06	39,94
Unit power input - Cooling	kW	1,5	1,5	1,5	1,87	1,87
EER		21,3	21,3	21,3	30,5	21,3
Water pressure drop	kPa	31,1	37,8	32,1	37,4	41,1
<b>DIMENSIONS</b>						
Height	mm	2540	2540	2540	2540	2540
Width	mm	2224	2224	2224	2224	2224
Length - Full Free Cooling	mm	3600	3600	3600	3614	3621
MODEL		EWAT280B-XRB2	EWAT300B-XRB1	EWAT310B-XRB2	EWAT320B-XRB2	EWAT360B-XRB1
<b>FULL FREE COOLING PERFORMANCE</b>						
Capacity - Cooling	kW	195,5	195,5	195,5	195,5	216,3
Unit power input - Cooling	kW	9,43	9,43	9,43	9,43	11
EER		20,7	20,7	20,7	20,7	19,7
Water pressure drop	kPa	23,3	23,5	26,9	30,2	22,7
<b>LIGHT FREE COOLING PERFORMANCE</b>						
Capacity - Cooling	kW	68,48	68,48	68,48	68,48	79,89
Unit power input - Cooling	kW	2,25	2,25	2,25	2,25	2,62
EER		30,5	30,5	30,5	30,5	30,5
Water pressure drop	kPa	30,4	46,8	34,6	38,4	60,6
<b>DIMENSIONS</b>						
Height	mm	2540	2540	2540	2540	2540
Width	mm	2224	2224	2224	2224	2224
Length - Full Free Cooling	mm	3621	3614	3621	3621	4147



MODEL		EWAT370B-XRB2	EWAT430B-XRB2	EWAT470B-XRB2	EWAT540B-XRB2	EWAT600B-XRB2
<b>FULL FREE COOLING PERFORMANCE</b>						
Capacity - Cooling	kW	228,1	260,7	293,3	325,9	391,1
Unit power input - Cooling	kW	11	12,6	14,2	15,7	18,9
EER		20,7	20,7	20,7	20,7	20,7
Water pressure drop	kPa	33,7	33,1	22,3	29	23,7
<b>LIGHT FREE COOLING PERFORMANCE</b>						
Capacity - Cooling	kW	79,89	91,3	102,7	114,1	137
Unit power input - Cooling	kW	2,62	3	3,37	3,74	4,49
EER		30,5	30,5	30,5	30,5	30,5
Water pressure drop	kPa	49,2	42,1	51,2	44,6	56,6
<b>DIMENSIONS</b>						
Height	mm	2540	2540	2540	2540	2540
Width	mm	2224	2224	2224	2224	2224
Length - Full Free Cooling	mm	4225	4225	5190	5190	5888
MODEL		EWAT660B-XRB2	EWAT700B-XRB2			
<b>FULL FREE COOLING PERFORMANCE</b>						
Capacity - Cooling	kW	411,8	423,4			
Unit power input - Cooling	kW	20,4	22			
EER		20,2	19,2			
Water pressure drop	kPa	23,6	26,6			
<b>LIGHT FREE COOLING PERFORMANCE</b>						
Capacity - Cooling	kW	148,4	159,8			
Unit power input - Cooling	kW	4,87	5,24			
EER		30,5	30,5			
Water pressure drop	kPa	53,2	59,2			
<b>DIMENSIONS</b>						
Height	mm	2540	2540			
Width	mm	2224	2224			
Length -Full Free Cooling	mm	6788	6788			

*\*All the performances (Cooling capacity, unit power input and EER) are based on the following conditions: evaporator 16,0/10,0°C; ambient 0°C, fouling factor = 0. Dimensions and weights are for indication only and not considered binding. Before designing the installation, consult the official drawings available from the factory at request. All the data are referred to standard unit without options. All data are subject to change without notice.*

**EWAT~B-SS/L**

MODEL		EWAT085B-SS(L)B1	EWAT115B-SS(L)B1	EWAT135B-SS(L)B1	EWAT155B-SS(L)B2	EWAT175B-SS(L)B1	EWAT195B-SS(L)B2
<b>POWER SUPPLY</b>							
Phases	No,	3	3	3	3	3	3
Frequency	Hz	50	50	50	50	50	50
Voltage	V	400	400	400	400	400	400
Voltage tolerance Minimum	%	-10%	-10%	-10%	-10%	-10%	-10%
Voltage tolerance Maximum	%	10%	10%	10%	10%	10%	10%
<b>UNIT</b>							
Maximum inrush current	A	213	313	324	284	462	384
Nominal running current cooling	A	59	69	83	112	113	122
Maximum running current	A	73	86	96	143	132	156
Maximum current for wires sizing	A	80	94	106	157	146	172
<b>FANS</b>							
Nominal running current cooling	A	4	6	6	8	8	10
<b>COMPRESSORS</b>							
Phases	No,	3	3	3	3	3	3
Voltage	V	400	400	400	400	400	400
Voltage tolerance Minimum	%	-10%	-10%	-10%	-10%	-10%	-10%
Voltage tolerance Maximum	%	10%	10%	10%	10%	10%	10%
Starting method		DOL	DOL	DOL	DOL	DOL	DOL

MODEL		EWAT205B-SS(L)B2	EWAT215B-SS(L)B1	EWAT240B-SS(L)B2	EWAT260B-SS(L)B2	EWAT290B-SS(L)B1	EWAT310B-SS(L)B2
<b>POWER SUPPLY</b>							
Phases	No,	3	3	3	3	3	3
Frequency	Hz	50	50	50	50	50	50
Voltage	V	400	400	400	400	400	400
Voltage tolerance Minimum	%	-10%	-10%	-10%	-10%	-10%	-10%
Voltage tolerance Maximum	%	10%	10%	10%	10%	10%	10%
<b>UNIT</b>							
Maximum inrush current	A	395	498	410	420	546	573
Nominal running current cooling	A	136	142	147	160	179	194
Maximum running current	A	167	168	182	193	216	243
Maximum current for wires sizing	A	184	185	200	212	238	267
<b>FANS</b>							
Nominal running current cooling	A	10	10	13	13	13	16
<b>COMPRESSORS</b>							
Phases	No,	3	3	3	3	3	3
Voltage	V	400	400	400	400	400	400
Voltage tolerance Minimum	%	-10%	-10%	-10%	-10%	-10%	-10%
Voltage tolerance Maximum	%	10%	10%	10%	10%	10%	10%
Starting method		DOL	DOL	DOL	DOL	DOL	DOL

Fluid: Water

Allowed voltage tolerance  $\pm 10\%$ , Voltage unbalance between phases must be within  $\pm 3\%$ .

Maximum starting current: In case of inverter driven units, no inrush current at start up is experienced.

Nominal current in cooling mode is referred to the following conditions: evaporator 12/7°C; ambient 35°C; compressors + fans current

Maximum running current is based on max compressor absorbed current in its envelope and max fans absorbed current

Maximum unit current for wires sizing is based on minimum allowed voltage

Maximum current for wires sizing: (compressors full load ampere + fans current) x 1,1

The data are referred to the standard unit without options

For the electrical data of the hydronic kit refer to "Options technical data"

All data are subject to change without notice, Please refer to unit nameplate data

EWAT~B-SS/L

MODEL		EWAT330B-SS(L)B2	EWAT340B-SS(L)B1	EWAT350B-SS(L)B2	EWAT420B-SS(L)B2	EWAT460B-SS(L)B2	EWAT510B-SS(L)B2
<b>POWER SUPPLY</b>							
Phases	No,	3	3	3	3	3	3
Frequency	Hz	50	50	50	50	50	50
Voltage	V	400	400	400	400	400	400
Voltage tolerance Minimum	%	-10%	-10%	-10%	-10%	-10%	-10%
Voltage tolerance Maximum	%	10%	10%	10%	10%	10%	10%
<b>UNIT</b>							
Maximum inrush current	A	583	588	594	636	681	719
Nominal running current cooling	A	207	197	220	238	285	310
Maximum running current	A	254	258	265	307	351	389
Maximum current for wires sizing	A	279	284	292	338	386	428
<b>FANS</b>							
Nominal running current cooling	A	16	20	16	23	23	26
<b>COMPRESSORS</b>							
Phases	No,	3	3	3	3	3	3
Voltage	V	400	400	400	400	400	400
Voltage tolerance Minimum	%	-10%	-10%	-10%	-10%	-10%	-10%
Voltage tolerance Maximum	%	10%	10%	10%	10%	10%	10%
Starting method		DOL	DOL	DOL	DOL	DOL	DOL

MODEL		EWAT570B-SS(L)B2	EWAT610B-SS(L)B2	EWAT670B-SS(L)B2
<b>POWER SUPPLY</b>				
Phases	No,	3	3	3
Frequency	Hz	50	50	50
Voltage	V	400	400	400
Voltage tolerance Minimum	%	-10%	-10%	-10%
Voltage tolerance Maximum	%	10%	10%	10%
<b>UNIT</b>				
Maximum inrush current	A	763	801	843
Nominal running current cooling	A	358	382	399
Maximum running current	A	433	471	513
Maximum current for wires sizing	A	476	518	564
<b>FANS</b>				
Nominal running current cooling	A	26	30	36
<b>COMPRESSORS</b>				
Phases	No,	3	3	3
Voltage	V	400	400	400
Voltage tolerance Minimum	%	-10%	-10%	-10%
Voltage tolerance Maximum	%	10%	10%	10%
Starting method		DOL	DOL	DOL

Fluid: Water

Allowed voltage tolerance  $\pm 10\%$ , Voltage unbalance between phases must be within  $\pm 3\%$ .

Maximum starting current: In case of inverter driven units, no inrush current at start up is experienced.

Nominal current in cooling mode is referred to the following conditions: evaporator 12/7°C; ambient 35°C; compressors + fans current

Maximum running current is based on max compressor absorbed current in its envelope and max fans absorbed current

Maximum unit current for wires sizing is based on minimum allowed voltage

Maximum current for wires sizing: (compressors full load ampere + fans current) x 1,1

The data are referred to the standard unit without options

For the electrical data of the hydronic kit refer to "Options technical data"

All data are subject to change without notice, Please refer to unit nameplate data

**EWAT~B-SR**

MODEL		EWAT085B-SRB1	EWAT115B-SRB1	EWAT135B-SRB1	EWAT155B-SRB2	EWAT175B-SRB1	EWAT195B-SRB2
<b>POWER SUPPLY</b>							
Phases	No,	3	3	3	3	3	3
Frequency	Hz	50	50	50	50	50	50
Voltage	V	400	400	400	400	400	400
Voltage tolerance Minimum	%	-10%	-10%	-10%	-10%	-10%	-10%
Voltage tolerance Maximum	%	10%	10%	10%	10%	10%	10%
<b>UNIT</b>							
Maximum inrush current	A	213	313	324	284	462	384
Nominal running current cooling	A	59	69	83	112	113	122
Maximum running current	A	73	86	96	143	132	156
Maximum current for wires sizing	A	80	94	106	157	146	172
<b>FANS</b>							
Nominal running current cooling	A	3	5	5	6	6	8
<b>COMPRESSORS</b>							
Phases	No,	3	3	3	3	3	3
Voltage	V	400	400	400	400	400	400
Voltage tolerance Minimum	%	-10%	-10%	-10%	-10%	-10%	-10%
Voltage tolerance Maximum	%	10%	10%	10%	10%	10%	10%
Starting method		DOL	DOL	DOL	DOL	DOL	DOL

MODEL		EWAT205B-SRB2	EWAT215B-SRB1	EWAT240B-SRB2	EWAT260B-SRB2	EWAT290B-SRB1	EWAT310B-SRB2
<b>POWER SUPPLY</b>							
Phases	No,	3	3	3	3	3	3
Frequency	Hz	50	50	50	50	50	50
Voltage	V	400	400	400	400	400	400
Voltage tolerance Minimum	%	-10%	-10%	-10%	-10%	-10%	-10%
Voltage tolerance Maximum	%	10%	10%	10%	10%	10%	10%
<b>UNIT</b>							
Maximum inrush current	A	395	498	410	420	546	573
Nominal running current cooling	A	136	142	147	160	179	194
Maximum running current	A	167	168	182	193	216	243
Maximum current for wires sizing	A	184	185	200	212	238	267
<b>FANS</b>							
Nominal running current cooling	A	8	8	9	9	9	11
<b>COMPRESSORS</b>							
Phases	No,	3	3	3	3	3	3
Voltage	V	400	400	400	400	400	400
Voltage tolerance Minimum	%	-10%	-10%	-10%	-10%	-10%	-10%
Voltage tolerance Maximum	%	10%	10%	10%	10%	10%	10%
Starting method		DOL	DOL	DOL	DOL	DOL	DOL

Fluid: Water

Allowed voltage tolerance  $\pm 10\%$ , Voltage unbalance between phases must be within  $\pm 3\%$ .

Maximum starting current: In case of inverter driven units, no inrush current at start up is experienced.

Nominal current in cooling mode is referred to the following conditions: evaporator 12/7°C; ambient 35°C; compressors + fans current

Maximum running current is based on max compressor absorbed current in its envelope and max fans absorbed current

Maximum unit current for wires sizing is based on minimum allowed voltage

Maximum current for wires sizing: (compressors full load ampere + fans current) x 1,1

The data are referred to the standard unit without options

For the electrical data of the hydronic kit refer to "Options technical data"

All data are subject to change without notice, Please refer to unit nameplate data

**EWAT~B-SR**

MODEL		EWAT330B-SRB2	EWAT340B-SRB1	EWAT350B-SRB2	EWAT420B-SRB2	EWAT460B-SRB2	EWAT510B-SRB2
<b>POWER SUPPLY</b>							
Phases	No,	3	3	3	3	3	3
Frequency	Hz	50	50	50	50	50	50
Voltage	V	400	400	400	400	400	400
Voltage tolerance Minimum	%	-10%	-10%	-10%	-10%	-10%	-10%
Voltage tolerance Maximum	%	10%	10%	10%	10%	10%	10%
<b>UNIT</b>							
Maximum inrush current	A	583	588	594	636	681	719
Nominal running current cooling	A	207	197	220	238	285	310
Maximum running current	A	254	258	265	307	351	389
Maximum current for wires sizing	A	279	284	292	338	386	428
<b>FANS</b>							
Nominal running current cooling	A	11	13	11	15	15	17
<b>COMPRESSORS</b>							
Phases	No,	3	3	3	3	3	3
Voltage	V	400	400	400	400	400	400
Voltage tolerance Minimum	%	-10%	-10%	-10%	-10%	-10%	-10%
Voltage tolerance Maximum	%	10%	10%	10%	10%	10%	10%
Starting method		DOL	DOL	DOL	DOL	DOL	DOL

MODEL		EWAT570B-SRB2	EWAT610B-SRB2	EWAT670B-SRB2
<b>POWER SUPPLY</b>				
Phases	No,	3	3	3
Frequency	Hz	50	50	50
Voltage	V	400	400	400
Voltage tolerance Minimum	%	-10%	-10%	-10%
Voltage tolerance Maximum	%	10%	10%	10%
<b>UNIT</b>				
Maximum inrush current	A	763	801	843
Nominal running current cooling	A	358	382	399
Maximum running current	A	433	471	513
Maximum current for wires sizing	A	476	518	564
<b>FANS</b>				
Nominal running current cooling	A	17	19	24
<b>COMPRESSORS</b>				
Phases	No,	3	3	3
Voltage	V	400	400	400
Voltage tolerance Minimum	%	-10%	-10%	-10%
Voltage tolerance Maximum	%	10%	10%	10%
Starting method		DOL	DOL	DOL

Fluid: Water

Allowed voltage tolerance  $\pm 10\%$ , Voltage unbalance between phases must be within  $\pm 3\%$ .

Maximum starting current: In case of inverter driven units, no inrush current at start up is experienced.

Nominal current in cooling mode is referred to the following conditions: evaporator 12/7°C; ambient 35°C; compressors + fans current

Maximum running current is based on max compressor absorbed current in its envelope and max fans absorbed current

Maximum unit current for wires sizing is based on minimum allowed voltage

Maximum current for wires sizing: (compressors full load ampere + fans current) x 1,1

The data are referred to the standard unit without options

For the electrical data of the hydronic kit refer to "Options technical data"

All data are subject to change without notice, Please refer to unit nameplate data

EWAT~B-XS/L

MODEL		EWAT085B-XS(L)B1	EWAT115B-XS(L)B1	EWAT145B-XS(L)B1	EWAT180B-XS(L)B2	EWAT185B-XS(L)B1	EWAT200B-XS(L)B2
<b>POWER SUPPLY</b>							
Phases	No,	3	3	3	3	3	3
Frequency	Hz	50	50	50	50	50	50
Voltage	V	400	400	400	400	400	400
Voltage tolerance Minimum	%	-10%	-10%	-10%	-10%	-10%	-10%
Voltage tolerance Maximum	%	10%	10%	10%	10%	10%	10%
<b>UNIT</b>							
Maximum inrush current	A	215	315	328	290	464	388
Nominal running current cooling	A	56	67	78	110	108	122
Maximum running current	A	75	87	100	149	134	160
Maximum current for wires sizing	A	83	96	110	164	147	176
<b>FANS</b>							
Nominal running current cooling	A	6	8	10	13	10	13
<b>COMPRESSORS</b>							
Phases	No,	3	3	3	3	3	3
Voltage	V	400	400	400	400	400	400
Voltage tolerance Minimum	%	-10%	-10%	-10%	-10%	-10%	-10%
Voltage tolerance Maximum	%	10%	10%	10%	10%	10%	10%
Starting method		DOL	DOL	DOL	DOL	DOL	DOL

MODEL		EWAT220B-XS(L)B2	EWAT230B-XS(L)B1	EWAT250B-XS(L)B2	EWAT280B-XS(L)B2	EWAT300B-XS(L)B1	EWAT310B-XS(L)B2
<b>POWER SUPPLY</b>							
Phases	No,	3	3	3	3	3	3
Frequency	Hz	50	50	50	50	50	50
Voltage	V	400	400	400	400	400	400
Voltage tolerance Minimum	%	-10%	-10%	-10%	-10%	-10%	-10%
Voltage tolerance Maximum	%	10%	10%	10%	10%	10%	10%
<b>UNIT</b>							
Maximum inrush current	A	399	506	414	543	554	554
Nominal running current cooling	A	135	128	145	158	168	171
Maximum running current	A	171	176	186	213	224	224
Maximum current for wires sizing	A	188	194	205	234	246	246
<b>FANS</b>							
Nominal running current cooling	A	13	16	16	20	20	20
<b>COMPRESSORS</b>							
Phases	No,	3	3	3	3	3	3
Voltage	V	400	400	400	400	400	400
Voltage tolerance Minimum	%	-10%	-10%	-10%	-10%	-10%	-10%
Voltage tolerance Maximum	%	10%	10%	10%	10%	10%	10%
Starting method		DOL	DOL	DOL	DOL	DOL	DOL

Fluid: Water

Allowed voltage tolerance  $\pm 10\%$ , Voltage unbalance between phases must be within  $\pm 3\%$ .

Maximum starting current: In case of inverter driven units, no inrush current at start up is experienced.

Nominal current in cooling mode is referred to the following conditions: evaporator 12/7°C; ambient 35°C; compressors + fans current

Maximum running current is based on max compressor absorbed current in its envelope and max fans absorbed current

Maximum unit current for wires sizing is based on minimum allowed voltage

Maximum current for wires sizing; (compressors full load ampere + fans current) x 1,1

The data are referred to the standard unit without options

For the electrical data of the hydronic kit refer to "Options technical data"

All data are subject to change without notice, Please refer to unit nameplate data

## ELECTRICAL SPECIFICATIONS

MODEL		EWAT320B- XS(L)B2	EWAT360B- XS(L)B1	EWAT370B- XS(L)B2	EWAT430B- XS(L)B2	EWAT470B- XS(L)B2	EWAT540B- XS(L)B2
<b>POWER SUPPLY</b>							
Phases	No,	3	3	3	3	3	3
Frequency	Hz	50	50	50	50	50	50
Voltage	V	400	400	400	400	400	400
Voltage tolerance Minimum	%	-10%	-10%	-10%	-10%	-10%	-10%
Voltage tolerance Maximum	%	10%	10%	10%	10%	10%	10%
<b>UNIT</b>							
Maximum inrush current	A	564	592	602	640	678	727
Nominal running current cooling	A	184	193	209	235	260	299
Maximum running current	A	235	262	273	311	348	397
Maximum current for wires sizing	A	259	288	300	342	383	437
<b>FANS</b>							
Nominal running current cooling	A	20	23	23	26	30	33
<b>COMPRESSORS</b>							
Phases	No,	3	3	3	3	3	3
Voltage	V	400	400	400	400	400	400
Voltage tolerance Minimum	%	-10%	-10%	-10%	-10%	-10%	-10%
Voltage tolerance Maximum	%	10%	10%	10%	10%	10%	10%
Starting method		DOL	DOL	DOL	DOL	DOL	DOL

MODEL		EWAT600B- XS(L)B2	EWAT660B- XS(L)B2	EWAT700B- XS(L)B2
<b>POWER SUPPLY</b>				
Phases	No,	3	3	3
Frequency	Hz	50	50	50
Voltage	V	400	400	400
Voltage tolerance Minimum	%	-10%	-10%	-10%
Voltage tolerance Maximum	%	10%	10%	10%
<b>UNIT</b>				
Maximum inrush current	A	777	817	855
Nominal running current cooling	A	335	361	388
Maximum running current	A	449	487	525
Maximum current for wires sizing	A	499	536	578
<b>FANS</b>				
Nominal running current cooling	A	40	43	46
<b>COMPRESSORS</b>				
Phases	No,	3	3	3
Voltage	V	400	400	400
Voltage tolerance Minimum	%	-10%	-10%	-10%
Voltage tolerance Maximum	%	10%	10%	10%
Starting method		DOL	DOL	DOL

Fluid: Water

Allowed voltage tolerance  $\pm 10\%$ , Voltage unbalance between phases must be within  $\pm 3\%$ .

Maximum starting current: In case of inverter driven units, no inrush current at start up is experienced.

Nominal current in cooling mode is referred to the following conditions: evaporator 12/7°C; ambient 35°C; compressors + fans current

Maximum running current is based on max compressor absorbed current in its envelope and max fans absorbed current

Maximum unit current for wires sizing is based on minimum allowed voltage

Maximum current for wires sizing: (compressors full load ampere + fans current)  $\times 1,1$

The data are referred to the standard unit without options

For the electrical data of the hydronic kit refer to "Options technical data"

All data are subject to change without notice, Please refer to unit nameplate data

**EWAT~B-XR**

MODEL		EWAT085B-XRB1	EWAT115B-XRB1	EWAT145B-XRB1	EWAT180B-XRB2	EWAT185B-XRB1	EWAT200B-XRB2
<b>POWER SUPPLY</b>							
Phases	No,	3	3	3	3	3	3
Frequency	Hz	50	50	50	50	50	50
Voltage	V	400	400	400	400	400	400
Voltage tolerance Minimum	%	-10%	-10%	-10%	-10%	-10%	-10%
Voltage tolerance Maximum	%	10%	10%	10%	10%	10%	10%
<b>UNIT</b>							
Maximum inrush current	A	215	315	328	290	464	388
Nominal running current cooling	A	56	67	78	110	108	122
Maximum running current	A	75	87	100	149	134	160
Maximum current for wires sizing	A	83	96	110	164	147	176
<b>FANS</b>							
Nominal running current cooling	A	6	8	10	8	10	8
<b>COMPRESSORS</b>							
Phases	No,	3	3	3	3	3	3
Voltage	V	400	400	400	400	400	400
Voltage tolerance Minimum	%	-10%	-10%	-10%	-10%	-10%	-10%
Voltage tolerance Maximum	%	10%	10%	10%	10%	10%	10%
Starting method		DOL	DOL	DOL	DOL	DOL	DOL

MODEL		EWAT220B-XRB2	EWAT230B-XRB1	EWAT250B-XRB2	EWAT280B-XRB2	EWAT300B-XRB1	EWAT310B-XRB2
<b>POWER SUPPLY</b>							
Phases	No,	3	3	3	3	3	3
Frequency	Hz	50	50	50	50	50	50
Voltage	V	400	400	400	400	400	400
Voltage tolerance Minimum	%	-10%	-10%	-10%	-10%	-10%	-10%
Voltage tolerance Maximum	%	10%	10%	10%	10%	10%	10%
<b>UNIT</b>							
Maximum inrush current	A	399	506	414	543	554	554
Nominal running current cooling	A	135	128	145	158	168	171
Maximum running current	A	171	176	186	213	224	224
Maximum current for wires sizing	A	188	194	205	234	246	246
<b>FANS</b>							
Nominal running current cooling	A	8	10	10	12	12	12
<b>COMPRESSORS</b>							
Phases	No,	3	3	3	3	3	3
Voltage	V	400	400	400	400	400	400
Voltage tolerance Minimum	%	-10%	-10%	-10%	-10%	-10%	-10%
Voltage tolerance Maximum	%	10%	10%	10%	10%	10%	10%
Starting method		DOL	DOL	DOL	DOL	DOL	DOL

Fluid: Water

Allowed voltage tolerance  $\pm 10\%$ , Voltage unbalance between phases must be within  $\pm 3\%$ .

Maximum starting current: In case of inverter driven units, no inrush current at start up is experienced.

Nominal current in cooling mode is referred to the following conditions: evaporator 12/7°C; ambient 35°C; compressors + fans current

Maximum running current is based on max compressor absorbed current in its envelope and max fans absorbed current

Maximum unit current for wires sizing is based on minimum allowed voltage

Maximum current for wires sizing: (compressors full load ampere + fans current) x 1,1

The data are referred to the standard unit without options

For the electrical data of the hydronic kit refer to "Options technical data"

All data are subject to change without notice, Please refer to unit nameplate data



MODEL		EWAT320B-XRB2	EWAT360B-XRB1	EWAT370B-XRB2	EWAT430B-XRB2	EWAT470B-XRB2	EWAT540B-XRB2
<b>POWER SUPPLY</b>							
Phases	No,	3	3	3	3	3	3
Frequency	Hz	50	50	50	50	50	50
Voltage	V	400	400	400	400	400	400
Voltage tolerance Minimum	%	-10%	-10%	-10%	-10%	-10%	-10%
Voltage tolerance Maximum	%	10%	10%	10%	10%	10%	10%
<b>UNIT</b>							
Maximum inrush current	A	564	592	602	640	678	727
Nominal running current cooling	A	184	193	209	235	260	299
Maximum running current	A	235	262	273	311	348	397
Maximum current for wires sizing	A	259	288	300	342	383	437
<b>FANS</b>							
Nominal running current cooling	A	12	14	14	16	19	21
<b>COMPRESSORS</b>							
Phases	No,	3	3	3	3	3	3
Voltage	V	400	400	400	400	400	400
Voltage tolerance Minimum	%	-10%	-10%	-10%	-10%	-10%	-10%
Voltage tolerance Maximum	%	10%	10%	10%	10%	10%	10%
Starting method		DOL	DOL	DOL	DOL	DOL	DOL

MODEL		EWAT600B-XRB2	EWAT660B-XRB2	EWAT700B-XRB2
<b>POWER SUPPLY</b>				
Phases	No,	3	3	3
Frequency	Hz	50	50	50
Voltage	V	400	400	400
Voltage tolerance Minimum	%	-10%	-10%	-10%
Voltage tolerance Maximum	%	10%	10%	10%
<b>UNIT</b>				
Maximum inrush current	A	777	817	855
Nominal running current cooling	A	335	361	388
Maximum running current	A	449	487	525
Maximum current for wires sizing	A	499	536	578
<b>FANS</b>				
Nominal running current cooling	A	25	27	29
<b>COMPRESSORS</b>				
Phases	No,	3	3	3
Voltage	V	400	400	400
Voltage tolerance Minimum	%	-10%	-10%	-10%
Voltage tolerance Maximum	%	10%	10%	10%
Starting method		DOL	DOL	DOL

Fluid: Water

Allowed voltage tolerance  $\pm 10\%$ , Voltage unbalance between phases must be within  $\pm 3\%$ .

Maximum starting current: In case of inverter driven units, no inrush current at start up is experienced.

Nominal current in cooling mode is referred to the following conditions: evaporator 12/7°C; ambient 35°C; compressors + fans current

Maximum running current is based on max compressor absorbed current in its envelope and max fans absorbed current

Maximum unit current for wires sizing is based on minimum allowed voltage

Maximum current for wires sizing: (compressors full load ampere + fans current) x 1,1

The data are referred to the standard unit without options

For the electrical data of the hydronic kit refer to "Options technical data"

All data are subject to change without notice, Please refer to unit nameplate data

**EWAT~B-SS**

MODEL	Sound pressure level at 1 m from the unit (rif, 2 x 10 <sup>-5</sup> Pa)									Sound Power	
	63 Hz	125 Hz	250 Hz	500 Hz	1000 Hz	2000 Hz	4000 Hz	8000 Hz	db(A)	db (A)	
85	61,4	66,3	65,6	63,2	62,4	60,1	57,5	51,8	<b>67,4</b>	<b>85</b>	
115	64,5	69,4	68,7	66,3	65,5	63,2	60,6	54,9	<b>70,5</b>	<b>88</b>	
135	66,0	70,9	70,1	67,8	66,9	64,7	62,1	56,4	<b>72,0</b>	<b>90</b>	
155	63,5	68,4	67,7	65,3	64,5	62,2	59,6	53,9	<b>69,5</b>	<b>88</b>	
175	67,8	72,6	71,9	69,6	68,7	66,5	63,9	58,1	<b>73,8</b>	<b>92</b>	
195	65,3	70,1	69,4	67,1	66,2	64,0	61,4	55,6	<b>71,3</b>	<b>90</b>	
205	66,3	71,2	70,5	68,1	67,3	65,0	62,4	56,7	<b>72,3</b>	<b>91</b>	
215	68,8	73,7	73,0	70,6	69,8	67,5	64,9	59,2	<b>74,8</b>	<b>93</b>	
240	68,3	73,2	72,4	70,1	69,3	67,0	64,4	58,7	<b>74,3</b>	<b>93</b>	
260	68,8	73,7	73,0	70,6	69,8	67,5	64,9	59,2	<b>74,8</b>	<b>94</b>	
290	69,8	74,7	74,0	71,6	70,8	68,5	65,9	60,2	<b>75,8</b>	<b>95</b>	
310	69,4	74,3	73,6	71,2	70,4	68,1	65,5	59,8	<b>75,4</b>	<b>95</b>	
330	69,8	74,6	73,9	71,6	70,7	68,5	65,9	60,1	<b>75,8</b>	<b>95</b>	
340	70,6	75,5	74,7	72,4	71,6	69,3	66,7	61,0	<b>76,6</b>	<b>96</b>	
350	70,1	75,0	74,2	71,9	71,1	68,8	66,2	60,5	<b>76,1</b>	<b>96</b>	
420	70,7	75,6	74,9	72,5	71,7	69,4	66,8	61,1	<b>76,7</b>	<b>97</b>	
460	71,0	75,9	75,2	72,8	72,0	69,7	67,1	61,4	<b>77,0</b>	<b>97</b>	
510	71,6	76,5	75,8	73,4	72,6	70,3	67,7	62,0	<b>77,6</b>	<b>98</b>	
570	71,9	76,7	76,0	73,7	72,8	70,6	68,0	62,2	<b>77,9</b>	<b>98</b>	
610	71,9	76,8	76,1	73,7	72,9	70,6	68,0	62,3	<b>77,9</b>	<b>98</b>	
670	72,2	77,1	76,3	74,0	73,1	70,9	68,3	62,6	<b>78,2</b>	<b>99</b>	

**EWAT~B-SL**

MODEL	Sound pressure level at 1 m from the unit (rif, 2 x 10 <sup>-5</sup> Pa)									Sound Power	
	63 Hz	125 Hz	250 Hz	500 Hz	1000 Hz	2000 Hz	4000 Hz	8000 Hz	db(A)	db (A)	
85	60,3	65,2	64,5	62,1	61,3	59,0	56,4	50,7	<b>66,3</b>	<b>84</b>	
115	62,5	67,4	66,6	64,3	63,4	61,2	58,6	52,9	<b>68,5</b>	<b>86</b>	
135	63,3	68,2	67,4	65,1	64,2	62,0	59,4	53,7	<b>69,3</b>	<b>87</b>	
155	62,4	67,3	66,5	64,2	63,3	61,1	58,5	52,8	<b>68,4</b>	<b>87</b>	
175	64,7	69,6	68,9	66,5	65,7	63,4	60,8	55,1	<b>70,7</b>	<b>89</b>	
195	63,5	68,4	67,7	65,3	64,5	62,2	59,6	53,9	<b>69,5</b>	<b>88</b>	
205	64,0	68,9	68,2	65,8	65,0	62,8	60,1	54,4	<b>70,1</b>	<b>89</b>	
215	65,6	70,5	69,8	67,4	66,6	64,3	61,7	56,0	<b>71,6</b>	<b>90</b>	
240	65,8	70,7	69,9	67,6	66,7	64,5	61,9	56,2	<b>71,8</b>	<b>91</b>	
260	65,8	70,7	70,0	67,6	66,8	64,5	61,9	56,2	<b>71,8</b>	<b>91</b>	
290	66,0	70,9	70,1	67,8	66,9	64,7	62,1	56,4	<b>72,0</b>	<b>91</b>	
310	66,3	71,2	70,5	68,1	67,3	65,0	62,4	56,7	<b>72,3</b>	<b>92</b>	
330	66,3	71,2	70,5	68,1	67,3	65,1	62,5	56,7	<b>72,4</b>	<b>92</b>	
340	67,1	72,0	71,3	68,9	68,1	65,9	63,2	57,5	<b>73,2</b>	<b>93</b>	
350	66,4	71,3	70,5	68,2	67,4	65,1	62,5	56,8	<b>72,4</b>	<b>92</b>	
420	67,3	72,2	71,5	69,1	68,3	66,0	63,4	57,7	<b>73,3</b>	<b>93</b>	
460	67,4	72,3	71,5	69,2	68,3	66,1	63,5	57,7	<b>73,4</b>	<b>93</b>	
510	68,0	72,8	72,1	69,8	68,9	66,7	64,1	58,3	<b>74,0</b>	<b>94</b>	
570	68,0	72,9	72,1	69,8	69,0	66,7	64,1	58,4	<b>74,0</b>	<b>94</b>	
610	68,1	73,0	72,2	69,9	69,0	66,8	64,2	58,5	<b>74,1</b>	<b>95</b>	
670	68,6	73,4	72,7	70,3	69,5	67,3	64,7	58,9	<b>74,6</b>	<b>95</b>	

Sound power level (referred to evaporator 12/7°C, ambient 35°C full load operation) are measured in accordance with ISO 9614 and Eurovent 8/1 for Eurovent certified units, The certification refers only to the overall sound power level. The sound data in the Octave band spectrum is for intended for reference only and not considering binding. The sound pressure is calculated from the sound power level and are for information only and not considered binding.

## EWAT~B-SR

MODEL	Sound pressure level at 1 m from the unit (rif, 2 x 10 <sup>-5</sup> Pa)									Sound Power
	63 Hz	125 Hz	250 Hz	500 Hz	1000 Hz	2000 Hz	4000 Hz	8000 Hz	db(A)	db (A)
85	55,2	60,1	59,4	57,0	56,2	53,9	51,3	45,6	61,2	79
115	58,7	63,6	62,9	60,5	59,7	57,4	54,8	49,1	64,7	83
135	60,4	65,3	64,6	62,2	61,4	59,1	56,5	50,8	66,4	84
155	57,3	62,2	61,4	59,1	58,2	56,0	53,4	47,7	63,3	82
175	62,3	67,2	66,5	64,1	63,3	61,0	58,4	52,7	68,3	86
195	59,3	64,2	63,5	61,1	60,3	58,0	55,4	49,7	65,3	84
205	60,6	65,5	64,8	62,4	61,6	59,3	56,7	51,0	66,6	85
215	63,4	68,3	67,6	65,2	64,4	62,1	59,5	53,8	69,4	88
240	62,1	66,9	66,2	63,9	63,0	60,8	58,2	52,4	68,1	87
260	62,2	67,1	66,4	64,0	63,2	60,9	58,3	52,6	68,2	87
290	62,5	67,4	66,7	64,3	63,5	61,2	58,6	52,9	68,5	88
310	62,7	67,6	66,8	64,5	63,6	61,4	58,8	53,1	68,7	88
330	62,8	67,7	66,9	64,6	63,8	61,5	58,9	53,2	68,8	88
340	63,6	68,5	67,8	65,4	64,6	62,3	59,7	54,0	69,6	89
350	62,9	67,8	67,1	64,7	63,9	61,6	59,0	53,3	68,9	88
420	63,8	68,7	67,9	65,6	64,7	62,5	59,9	54,2	69,8	90
460	63,9	68,8	68,0	65,7	64,8	62,6	60,0	54,2	69,9	90
510	64,5	69,3	68,6	66,3	65,4	63,2	60,6	54,8	70,5	90
570	64,5	69,4	68,7	66,3	65,5	63,2	60,6	54,9	70,5	91
610	64,6	69,5	68,8	66,4	65,6	63,3	60,7	55,0	70,6	91
670	65,0	69,9	69,2	66,8	66,0	63,8	61,2	55,4	71,1	92

## EWAT~B-XS

MODEL	Sound pressure level at 1 m from the unit (rif, 2 x 10 <sup>-5</sup> Pa)									Sound Power
	63 Hz	125 Hz	250 Hz	500 Hz	1000 Hz	2000 Hz	4000 Hz	8000 Hz	db(A)	db (A)
85	62,3	67,2	66,5	64,1	63,3	61,0	58,4	52,7	68,3	86
115	64,8	69,7	69,0	66,6	65,8	63,5	60,9	55,2	70,8	89
145	66,2	71,0	70,3	68,0	67,1	64,9	62,3	56,5	72,2	91
180	66,3	71,1	70,4	68,1	67,2	65,0	62,4	56,6	72,3	91
185	67,7	72,6	71,8	69,5	68,6	66,4	63,8	58,1	73,7	92
200	67,0	71,9	71,2	68,8	68,0	65,8	63,1	57,4	73,1	92
220	67,7	72,6	71,9	69,5	68,7	66,4	63,8	58,1	73,7	93
230	69,3	74,1	73,4	71,1	70,2	68,0	65,4	59,6	75,3	95
250	68,3	73,2	72,5	70,1	69,3	67,0	64,4	58,7	74,3	94
280	69,1	74,0	73,3	70,9	70,1	67,8	65,2	59,5	75,1	95
300	70,1	74,9	74,2	71,9	71,0	68,8	66,2	60,4	76,1	96
310	69,5	74,4	73,7	71,3	70,5	68,2	65,6	59,9	75,5	95
320	69,9	74,7	74,0	71,7	70,8	68,6	66,0	60,2	75,9	95
360	70,4	75,3	74,6	72,2	71,4	69,1	66,5	60,8	76,4	96
370	70,3	75,1	74,4	72,0	71,2	69,0	66,4	60,6	76,3	96
430	71,0	75,9	75,1	72,8	71,9	69,7	67,1	61,3	77,0	97
470	71,2	76,1	75,3	73,0	72,1	69,9	67,3	61,5	77,2	98
540	71,6	76,5	75,8	73,4	72,6	70,3	67,7	62,0	77,6	98
600	71,8	76,7	76,0	73,6	72,8	70,5	67,9	62,2	77,8	99
660	71,9	76,8	76,0	73,7	72,8	70,6	68,0	62,3	77,9	99
700	72,3	77,2	76,4	74,1	73,2	71,0	68,4	62,7	78,3	99

Sound power level (referred to evaporator 12/7°C, ambient 35°C full load operation) are measured in accordance with ISO 9614 and Eurovent 8/1 for Eurovent certified units, The certification refers only to the overall sound power level.  
The sound data in the Octave band spectrum is for intended for reference only and not considering binding.  
The sound pressure is calculated from the sound power level and are for information only and not considered binding.

## EWAT~B-XL

MODEL	Sound pressure level at 1 m from the unit (rif, 2 x 10 <sup>-5</sup> Pa)									Sound Power
	63 Hz	125 Hz	250 Hz	500 Hz	1000 Hz	2000 Hz	4000 Hz	8000 Hz	db(A)	db (A)
85	61,5	66,4	65,6	63,3	62,5	60,2	57,6	51,9	67,5	85
115	63,1	68,0	67,2	64,9	64,0	61,8	59,2	53,5	69,1	87
145	64,1	69,0	68,2	65,9	65,0	62,8	60,2	54,4	70,1	89
180	65,6	70,5	69,7	67,4	66,5	64,3	61,7	56,0	71,6	91
185	64,9	69,8	69,1	66,7	65,9	63,6	61,0	55,3	70,9	89
200	65,7	70,5	69,8	67,5	66,6	64,4	61,8	56,0	71,7	91
220	65,7	70,6	69,9	67,5	66,7	64,4	61,8	56,1	71,7	91
230	66,3	71,2	70,4	68,1	67,2	65,0	62,4	56,7	72,3	92
250	66,2	71,1	70,3	68,0	67,1	64,9	62,3	56,5	72,2	92
280	67,0	71,9	71,1	68,8	67,9	65,7	63,1	57,3	73,0	93
300	66,3	71,2	70,4	68,1	67,2	65,0	62,4	56,7	73,1	93
310	67,0	71,9	71,2	68,8	68,0	65,7	63,1	57,4	73,0	93
320	67,0	71,9	71,2	68,8	68,0	65,8	63,2	57,4	73,1	93
360	67,3	72,2	71,4	69,1	68,3	66,0	63,4	57,7	73,3	93
370	67,3	72,2	71,4	69,1	68,2	66,0	63,4	57,6	73,3	93
430	67,9	72,8	72,0	69,7	68,8	66,6	64,0	58,2	73,9	94
470	68,0	72,9	72,1	69,8	68,9	66,7	64,1	58,3	74,0	94
540	68,4	73,3	72,6	70,2	69,4	67,1	64,5	58,8	74,4	95
600	68,8	73,7	73,0	70,6	69,8	67,5	64,9	59,2	74,8	96
660	68,8	73,7	73,0	70,67	69,8	67,5	64,9	59,2	74,8	96
700	69,2	74,0	73,3	71,0	70,1	67,9	65,3	59,5	75,2	96

## EWAT~B-XR

MODEL	Sound pressure level at 1 m from the unit (rif, 2 x 10 <sup>-5</sup> Pa)									Sound Power
	63 Hz	125 Hz	250 Hz	500 Hz	1000 Hz	2000 Hz	4000 Hz	8000 Hz	db(A)	db (A)
85	54,2	59,1	58,3	56,0	55,1	52,9	50,3	44,6	60,2	78
115	57,9	62,8	62,0	59,7	58,8	56,6	54,0	48,3	63,9	82
145	59,6	64,5	63,7	61,4	60,5	58,3	55,7	50,0	65,6	84
180	59,3	64,1	63,4	61,1	60,2	58,0	55,4	49,6	65,3	84
185	61,6	66,5	65,8	63,4	62,6	60,4	57,7	52,0	67,7	86
200	59,5	64,4	63,7	61,3	60,5	58,2	55,6	49,9	65,5	85
220	59,8	64,7	63,9	61,6	60,7	58,5	55,9	50,1	65,8	85
230	60,7	65,6	64,8	62,5	61,6	59,4	56,8	51,1	66,7	86
250	60,3	65,2	64,4	62,1	61,2	59,0	56,4	50,6	66,3	86
280	61,1	66,0	65,2	62,9	62,0	59,8	57,2	51,4	67,1	87
300	61,5	66,4	65,6	63,3	62,4	60,2	57,6	51,8	67,5	87
310	61,2	66,1	65,4	63,0	62,2	59,9	57,3	51,6	67,2	87
320	61,4	66,3	65,5	63,2	62,3	60,1	57,5	51,8	67,4	87
360	61,7	66,6	65,9	63,5	62,7	60,5	57,9	52,1	67,8	88
370	61,7	66,6	65,8	63,5	62,6	60,4	57,8	52,0	67,7	88
430	62,3	67,2	66,5	64,1	63,3	61,0	58,4	52,7	68,3	88
470	62,5	67,3	66,6	64,3	63,4	61,2	58,6	52,8	68,5	89
540	62,9	67,8	67,1	64,7	63,9	61,6	59,0	53,3	68,9	89
600	63,2	68,1	67,4	65,0	64,2	61,9	59,3	53,6	69,2	90
660	63,3	68,1	67,4	65,1	64,2	62,0	59,4	53,6	69,3	90
700	63,6	68,5	67,8	65,4	64,6	62,3	59,7	54,0	69,6	91

Sound power level (referred to evaporator 12/7°C, ambient 35°C full load operation) are measured in accordance with ISO 9614 and Eurovent 8/1 for Eurovent certified units, The certification refers only to the overall sound power level.

The sound data in the Octave band spectrum is for intended for reference only and not considering binding.

The sound pressure is calculated from the sound power level and are for information only and not considered binding.

Operating limits

EWAT~B-S (SILVER SERIES)

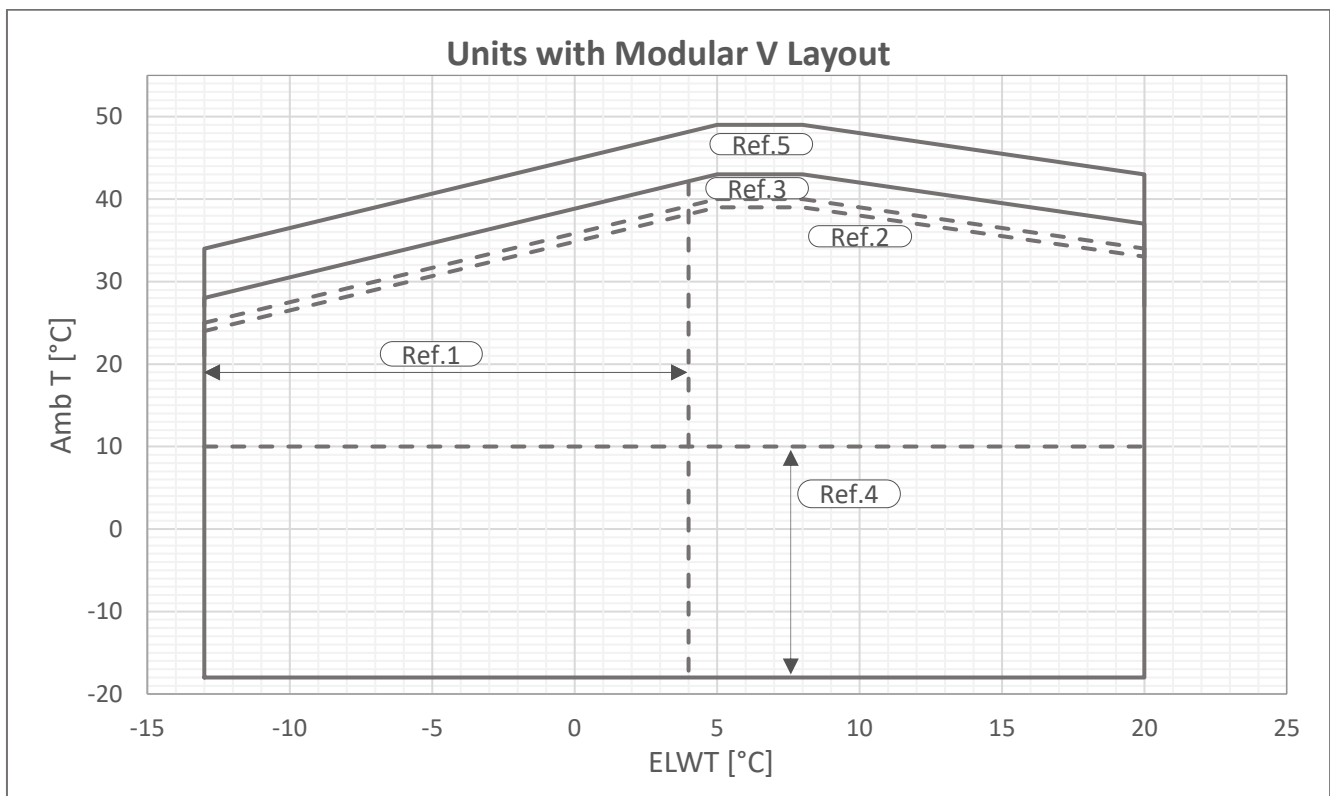
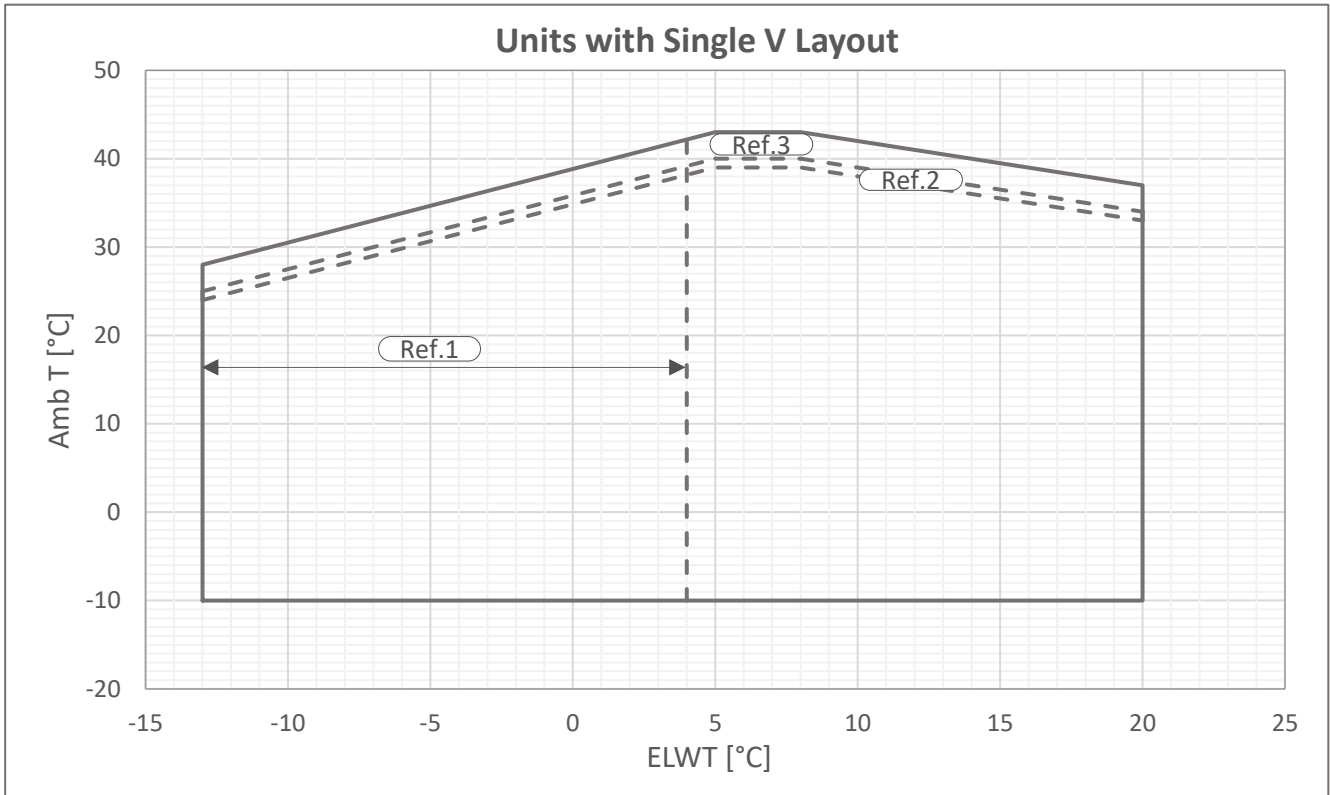

- Ref. 1 Operations below 4°C Evaporator Leaving Temperature require opt 08 (brine) and glycol.
- Ref. 2 Units with Reduced Sound configuration might increase their sound level in this area.
- Ref. 3 Certain unit sizes might work in part load in this area (Full load operation might need High Ambient Kit OP. 142A/B/C depending the layout/version unit). Refer to Chiller Selection Software for detailed information.
- Ref. 4 In Modular-V units, operations below 10°C Ambient Temperature require Opt 99a (fan speed modulation) or OP. 42 (Speedtroll). Standard if Free Cooling options (171-172-173) and OP. 142C are selected.
- Ref. 5 In Modular-V units operations above the Ref.3 limit require OP. 142 B (for Standard and Low Sound models) or OP. 142 C (for Reduced Sound models), some units may work in part load.

The above graphic represents a guideline about the operating limits of the range. Please refer to the latest Chiller Selection Software (CSS) for real operating limits working conditions for each size.

**EWAT~B-X (GOLD SERIES)**

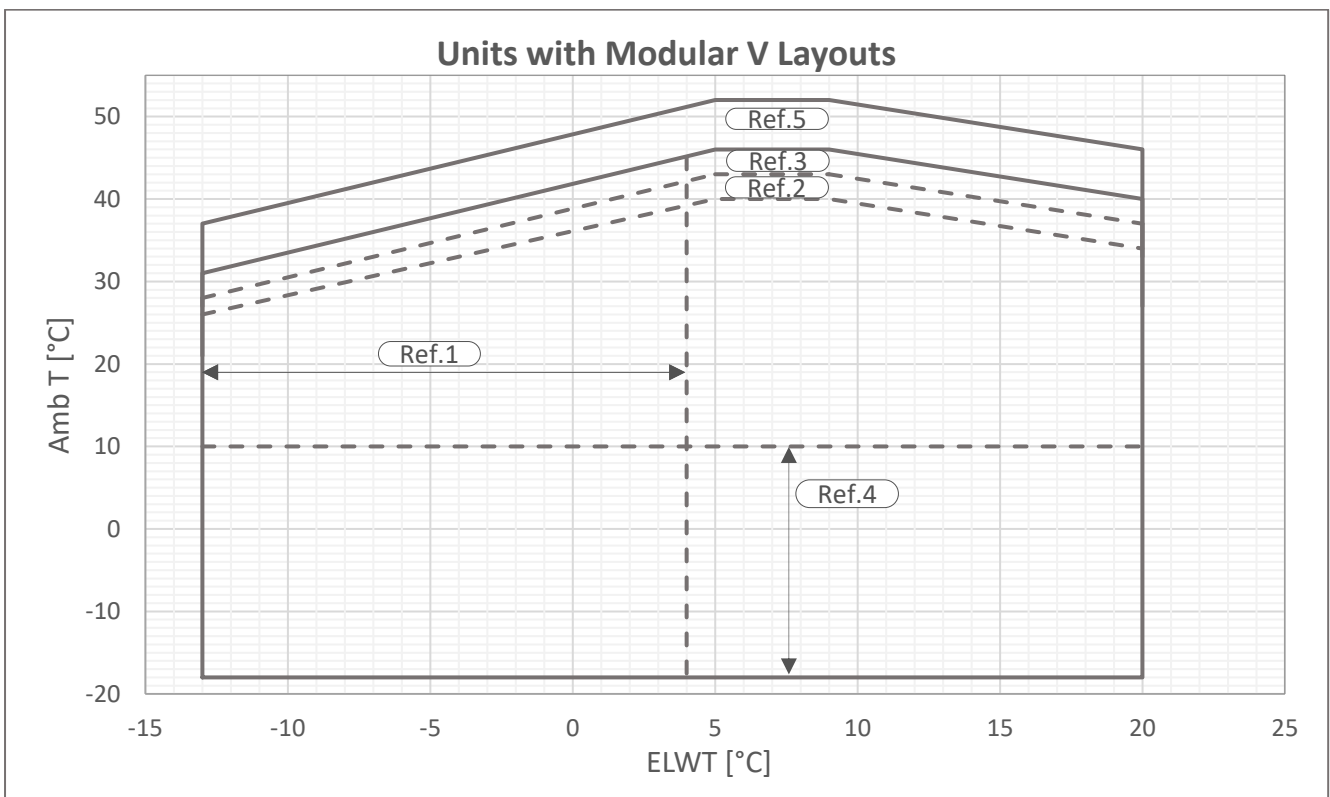
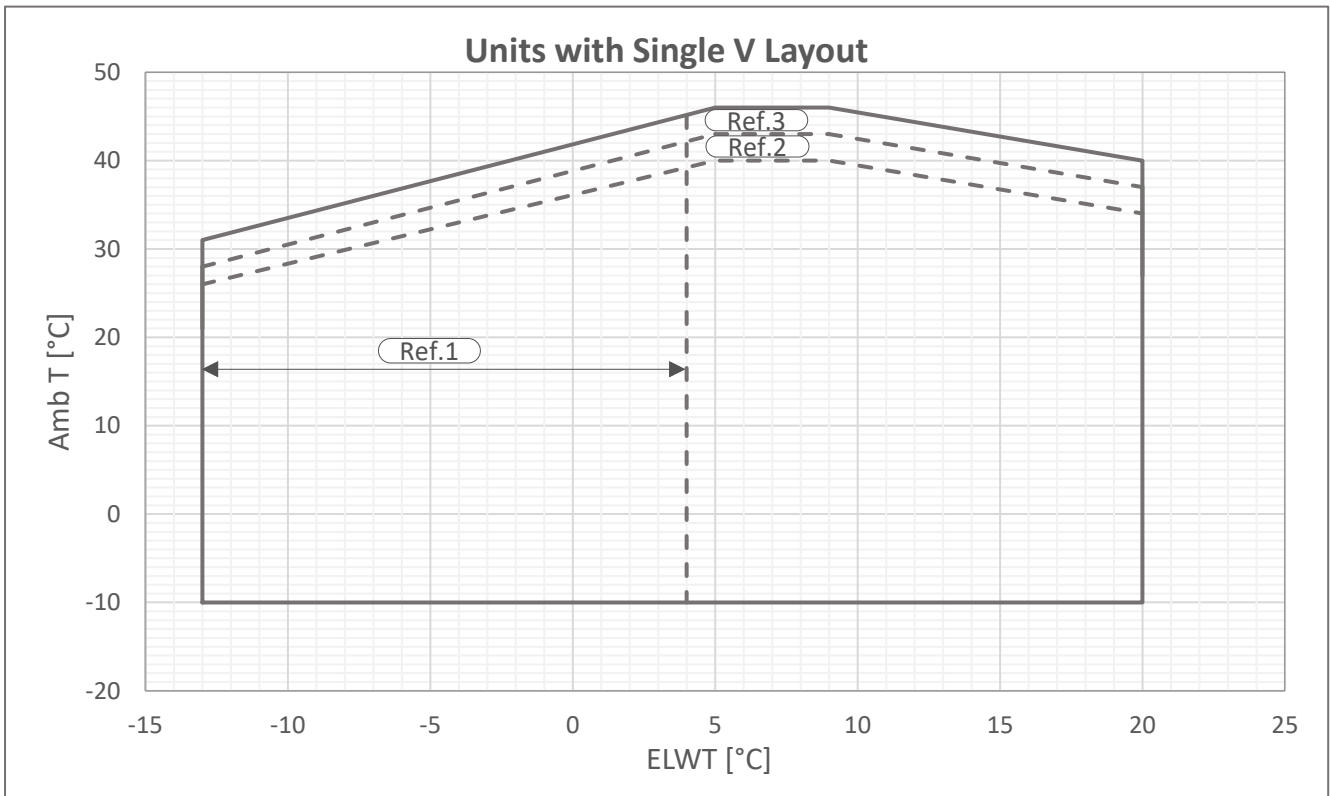

- Ref. 1 Operations below 4°C Evaporator Leaving Temperature require opt 08 (brine) and glycol.
- Ref. 2 Units with Reduced Sound configuration might increase their sound level in this area.
- Ref. 3 Certain unit sizes might work in part load in this area (Full load operation might need High Ambient Kit OP. 142A/B/C depending the layout/version unit). Refer to Chiller Selection Software for detailed information.
- Ref. 4 In Modular-V units, operations below 10°C Ambient Temperature require Opt 99a (fan speed modulation) or OP. 42 (Speedtroll). Standard if Free Cooling options (171-172-173) and OP. 142C are selected.
- Ref. 5 In Modular-V units operations above the Ref.3 limit require OP. 142 B (for Standard and Low Sound models) or OP. 142 C (for Reduced Sound models), some units may work in part load.

The above graphic represents a guideline about the operating limits of the range. Please refer to the latest Chiller Selection Software (CSS) for real operating limits working conditions for each size.

**Water heat exchanger - maximum/maximum water Δt**

The minimum and maximum allowed Δt at full load conditions are respectively 2,5 °C and 10°C. Contact factory in case lower or higher Δt are required. Minimum and maximum evaporator flows are to be respected withing the Δt range above.

**Water flow**

The following tables indicate the minimum and maximum water flow allowed for each model. For application with Variable Primary Flow (OP. code 143) refer to the following value for the dimensioning of the bypass line.

In case of variable flow application where the speed of the pump is managed by an external BMS (through 0- 10V signal) the change in water flow rate must not be exceed more than 10% of design water flow rate (at standard conditions) per minute.

The minimum flow indicated correspond to the minimum flow allowed at minimum load for the unit. It is not intended as minimum flow allowed for unit full load operation.

For minimum flow allowed (maximum deltaT) in full load operation refer to Selection Software.

The below values are referred to pure water (in case of glycol mixture contact factory).

Note: the performances are certified at standard conditions and with the unit operating with the nominal water flow (corresponding to OAT 35°C; water in/out 12/7°C).

SILVER EFFICIENCY UNITS			GOLD EFFICIENCY UNITS		
MODEL	Min Flow [l/s]	Max flow [l/s]	MODEL	Min flow [l/s]	Max flow [l/s]
EWAT085B-SS(L)(R)B1	1,8	9,0	EWAT085B-XS(L)(R)B1	1,8	9,0
EWAT115B-SS(L)(R)B1	2,0	10,3	EWAT115B-XS(L)(R)B1	2,0	10,3
EWAT135B-SS(L)(R)B1	2,7	14,8	EWAT145B-XS(L)(R)B1	2,7	14,8
EWAT155B-SS(L)(R)B2	2,3	11,9	EWAT180B-XS(L)(R)B2	3,6	17,0
EWAT175B-SS(L)(R)B1	3,5	16,6	EWAT185B-XS(L)(R)B1	3,5	16,6
EWAT195B-SS(L)(R)B2	3,6	17,0	EWAT200B-XS(L)(R)B2	3,6	17,0
EWAT205B-SS(L)(R)B2	3,6	17,0	EWAT220B-XS(L)(R)B2	4,3	20,0
EWAT215B-SS(L)(R)B1	4,3	20,5	EWAT230B-XS(L)(R)B1	4,3	20,5
EWAT240B-SS(L)(R)B2	3,6	17,0	EWAT250B-XS(L)(R)B2	4,3	20,0
EWAT260B-SS(L)(R)B2	3,6	17,0	EWAT280B-XS(L)(R)B2	5,6	26,5
EWAT290B-SS(L)(R)B1	4,3	20,5	EWAT300B-XS(L)(R)B1	4,9	23,1
EWAT310B-SS(L)(R)B2	5,6	26,5	EWAT310B-XS(L)(R)B2	5,6	26,5
EWAT330B-SS(L)(R)B2	5,6	26,5	EWAT320B-XS(L)(R)B2	5,6	26,5
EWAT340B-SS(L)(R)B1	4,9	23,1	EWAT360B-XS(L)(R)B1	4,9	23,1
EWAT350B-SS(L)(R)B2	5,6	26,5	EWAT370B-XS(L)(R)B2	5,6	26,5
EWAT420B-SS(L)(R)B2	7,0	31,2	EWAT430B-XS(L)(R)B2	7,0	31,2
EWAT460B-SS(L)(R)B2	7,0	31,2	EWAT470B-XS(L)(R)B2	7,0	31,2
EWAT510B-SS(L)(R)B2	7,0	31,2	EWAT540B-XS(L)(R)B2	8,8	41,2
EWAT570B-SS(L)(R)B2	8,8	41,2	EWAT600B-XS(L)(R)B2	8,8	41,2
EWAT610B-SS(L)(R)B2	8,8	41,2	EWAT660B-XS(L)(R)B2	9,9	46,0
EWAT670B-SS(L)(R)B2	8,8	41,2	EWAT700B-XS(L)(R)B2	9,9	46,0

**Minimum glycol percentage for low air ambient temperature to prevent freezing of the hydraulic circuit**

AMBIENT T [°C]	-3	-8	-15	-20	AMBIENT T [°C]	-3	-8	-15	-20
ETHYLENE GLYCOL	10%	20%	30%	40%	PROPYLENE GLYCOL	10%	20%	30%	40%

The presence of glycol in the water system will affect unit performances. Refer to the selection software for details. All machine protection systems, such as antifreeze and low-pressure protection will need to be set in accordance to the type and percentage of the glycol and plant requirements.

**Air heat exchanger - Altitude correction factors**

ELEVATION ABOVE SEA LEVEL [m]	0	300	600	900	1200	1500	1800
BAROMETRIC PRESSURE [mbar]	1013	997	942	908	875	843	812
COOLING CAPACITY CORRECTION FACTOR	1	0,993	0,986	0,979	0,973	0,967	0,96
POWER INPUT CORRECTION FACTOR	1	1,005	1,009	1,015	1,021	1,026	1,031

Maximum operating altitude is 1800 m above sea level.  
Contact factory if the unit has to be installed 1000 m above the sea level.

**Available fan static pressure correction factors**

EXTERNAL STATIC PRESSURE [Pa]	0	10	20	30
COOLING CAPACITY CORRECTION FACTOR	1	0,998	0,995	0,990
COMPRESSOR POWER INPUT CORRECTION FACTOR	1	1,006	1,010	1,020
REDUCTION OF MAX OPERATING AMBIENT TEMPERATURE [°C]	1	-0,3	-0,5	-1

The above table is valid for SILVER and GOLD series with standard and VFD driven fans. Application with more than 30 Pa of external static pressure are not recommended. In case where external static pressure over 30 Pa is required special high ESP fans are required.

**Maximum cable dimension**

Maximum cable dimension that can be physically connected to mainswitch of the unit. The table below can change in case of High Ambient Kit is selected.

Model	Max cable size	Model	Max cable size
EWAT085B-SS(L)(R)B1	3x70mm <sup>2</sup>	EWAT085B-XS(L)(R)B1	3x70mm <sup>2</sup>
EWAT115B-SS(L)(R)B1	3x70mm <sup>2</sup>	EWAT115B-XS(L)(R)B1	3x70mm <sup>2</sup>
EWAT135B-SS(L)(R)B1	3x70mm <sup>2</sup>	EWAT145B-XS(L)(R)B1	3x70mm <sup>2</sup>
EWAT155B-SS(L)(R)B2	3x95mm <sup>2</sup>	EWAT180B-XS(L)(R)B2	3x95mm <sup>2</sup>
EWAT175B-SS(L)(R)B1	3x95mm <sup>2</sup>	EWAT185B-XS(L)(R)B1	3x95mm <sup>2</sup>
EWAT195B-SS(L)(R)B2	3x95mm <sup>2</sup>	EWAT200B-XS(L)(R)B2	3x120mm <sup>2</sup>
EWAT205B-SS(L)(R)B2	3x120mm <sup>2</sup>	EWAT220B-XS(L)(R)B2	3x120mm <sup>2</sup>
EWAT215B-SS(L)(R)B1	3x120mm <sup>2</sup>	EWAT230B-XS(L)(R)B1	3x120mm <sup>2</sup>
EWAT240B-SS(L)(R)B2	3x240mm <sup>2</sup>	EWAT250B-XS(L)(R)B2	3x240mm <sup>2</sup>
EWAT260B-SS(L)(R)B2	3x240mm <sup>2</sup>	EWAT280B-XS(L)(R)B2	3x240mm <sup>2</sup>
EWAT290B-SS(L)(R)B1	3x240mm <sup>2</sup>	EWAT300B-XS(L)(R)B1	3x240mm <sup>2</sup>
EWAT310B-SS(L)(R)B2	3x240mm <sup>2</sup>	EWAT310B-XS(L)(R)B2	3x240mm <sup>2</sup>
EWAT330B-SS(L)(R)B2	3x240mm <sup>2</sup>	EWAT320B-XS(L)(R)B2	3x240mm <sup>2</sup>
EWAT340B-SS(L)(R)B1	3x240mm <sup>2</sup>	EWAT360B-XS(L)(R)B1	3x240mm <sup>2</sup>
EWAT350B-SS(L)(R)B2	3x240mm <sup>2</sup>	EWAT370B-XS(L)(R)B2	3x240mm <sup>2</sup>
EWAT420B-SS(L)(R)B2	3x2x185mm <sup>2</sup>	EWAT430B-XS(L)(R)B2	3x2x185mm <sup>2</sup>
EWAT460B-SS(L)(R)B2	3x2x185mm <sup>2</sup>	EWAT470B-XS(L)(R)B2	3x2x185mm <sup>2</sup>
EWAT510B-SS(L)(R)B2	3x2x185mm <sup>2</sup>	EWAT540B-XS(L)(R)B2	3x2x185mm <sup>2</sup>
EWAT570B-SS(L)(R)B2	3x2x185mm <sup>2</sup>	EWAT600B-XS(L)(R)B2	3x2x185mm <sup>2</sup>
EWAT610B-SS(L)(R)B2	3x2x185mm <sup>2</sup>	EWAT660B-XS(L)(R)B2	3x2x240mm <sup>2</sup>
EWAT670B-SS(L)(R)B2	3x2x240mm <sup>2</sup>	EWAT700B-XS(L)(R)B2	3x2x240mm <sup>2</sup>

**Heat recovery** Units may be optionally equipped with heat recovery system. This system is made by a water-cooled heat exchanger located on the compressors discharge pipe and a dedicated management of condensing pressure.

To guarantee compressor operation within its envelope, units with heat recovery cannot operate with water temperature of the heat recovery water lower than 20°C.

It is a responsibility of plant designer and chiller installer to guarantee the respect of this value (e.g. using recirculating bypass valve).

**Plant water content** The cooled water distribution circuits should have minimum water content to avoid excessive compressors start and stop. In fact, each time the compressor starts up, an excessive quantity of oil goes from the compressor sump and simultaneously there is a rise in the temperature of the compressor motor’s stator due to the inrush current during the start – up. To prevent damage to the compressors, have been envisaged the application of a device to limit frequent stops and restarts.

During the span of one hour there will be no more than 10 starts of the compressor. The plant side should therefore ensure that the overall water content allows a more constant functioning of the unit and consequently greater environmental comfort.

The calculation of the water content should also consider the plant’s design parameters.

As a general indication the water content should not be less than 5 lt/kW on single circuit units and 2,5l/kW on the twin circuit units.

Note: The indication is intended as a general guideline and not intended to substitute the evaluation made by qualified technical personnel or by HVAC engineers. For more detailed analysis is better to consider the use of other more detailed approach.



**Water quality** Before putting the unit into operation, clean the water circuit. Dirt, scales, corrosion debris and other material can accumulate inside the heat exchanger and reduce its heat exchanging capacity. Pressure drop can increase as well, thus reducing water flow. Proper water treatment therefore reduces the risk of corrosion, erosion, scaling, etc. The most appropriate water treatment must be determined locally, according to the type of system and water characteristics. The manufacturer is not responsible for damage to or malfunctioning of equipment caused by failure to treat water or by improperly treated water. Plant water must respect the following table;

DAE Water quality requirements	BPHE
Ph (25 °C)	7.5 – 9.0
Electrical conductivity [ $\mu\text{S}/\text{cm}$ ] (25°C)	< 500
Chloride ion [ $\text{mg Cl}^- / \text{l}$ ]	< 70 (HP <sup>1</sup> ) < 300 (CO <sup>2</sup> )
Sulphate ion [ $\text{mg SO}_4^{2-} / \text{l}$ ]	< 100
Alkalinity [ $\text{mg CaCO}_3 / \text{l}$ ]	< 200
Total Hardness [ $\text{mg CaCO}_3 / \text{l}$ ]	75 ÷ 150
Iron [ $\text{mg Fe} / \text{l}$ ]	< 0.2
Ammonium ion [ $\text{mg NH}_4^+ / \text{l}$ ]	< 0.5
Silica [ $\text{mg SiO}_2 / \text{l}$ ]	-
Chlorine molecular ( $\text{mg Cl}_2/\text{l}$ )	< 0.5

Note: 1. Heat Pump  
2. Cooling Only

**EWAT~B-S (SILVER SERIES) – Single pump low lift**

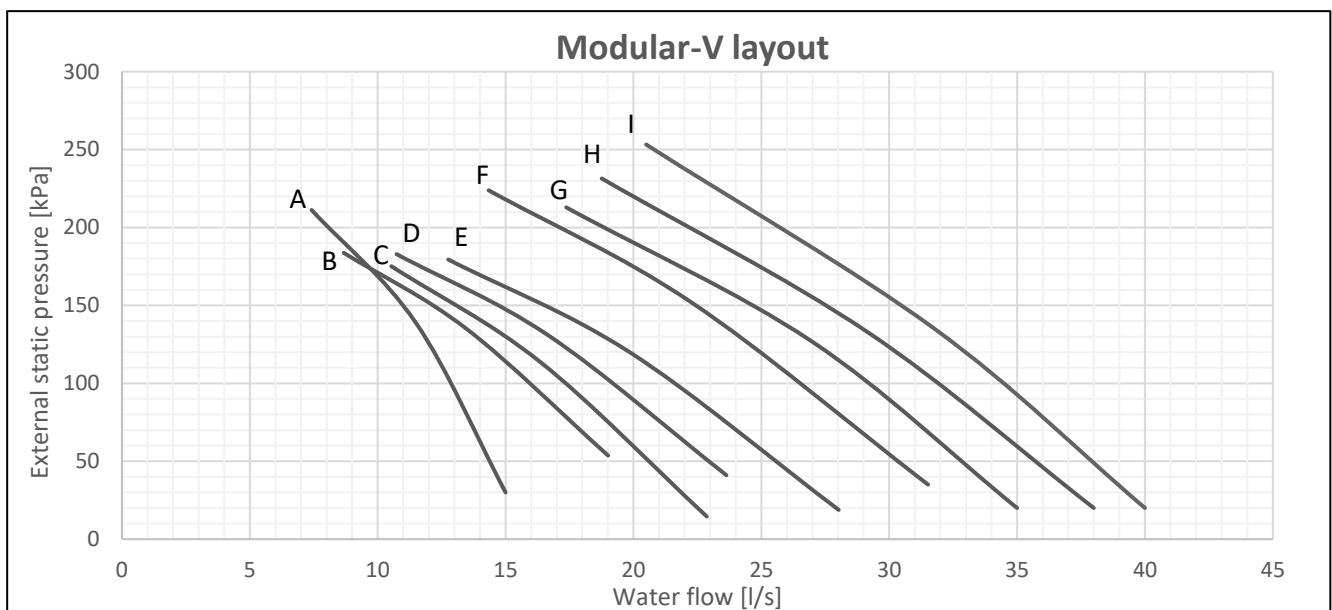
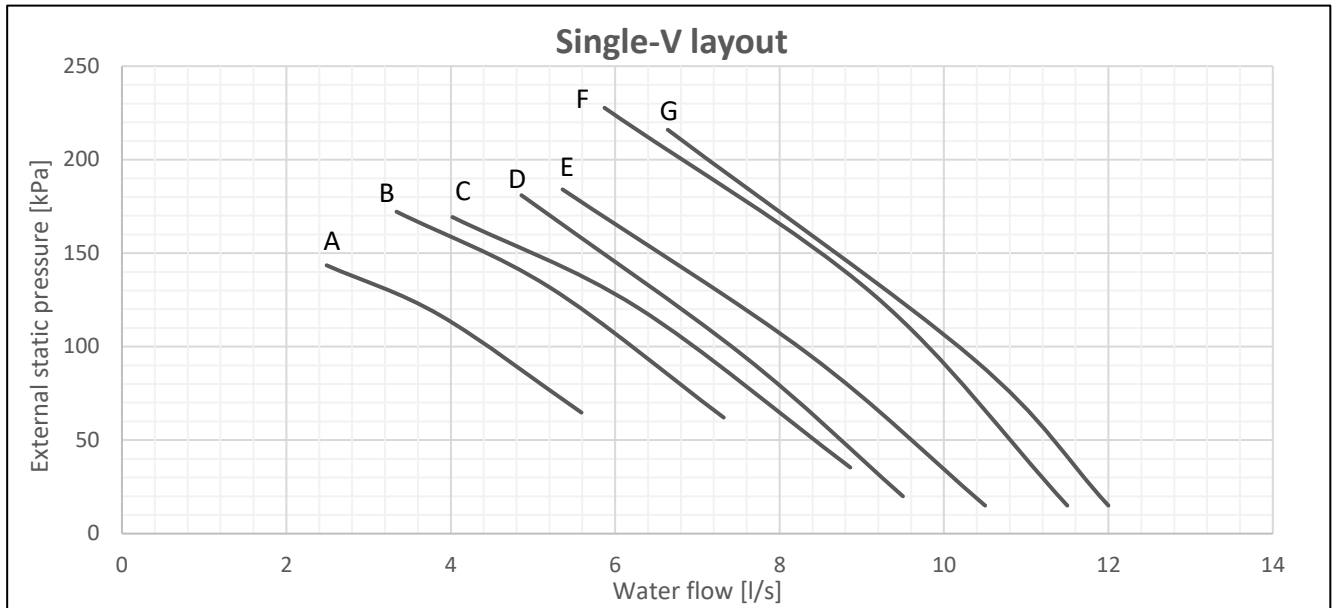

Single-V layout	Pump curve	Pump motor power [kW]	Pump motor current [A]
EWAT085B-SS(L)(R)B1	A	1,4	2,5
EWAT115B-SS(L)(R)B1	B	2,0	3,4
EWAT135B-SS(L)(R)B1	C	2,0	3,4
EWAT155B-SS(L)(R)B2	D	2,5	4,5
EWAT175B-SS(L)(R)B1	E	2,5	4,5
EWAT195B-SS(L)(R)B2	F	3,3	5,8
EWAT205B-SS(L)(R)B2	F	3,3	5,8
EWAT215B-SS(L)(R)B1	G	3,3	5,8

Modular-V layout	Pump curve	Pump motor power [kW]	Pump motor current [A]
EWAT240B-SS(L)(R)B2	A	2,2	4,5
EWAT260B-SS(L)(R)B2	A	4,0	7,6
EWAT290B-SS(L)(R)B1	B	3,0	6,3
EWAT310B-SS(L)(R)B2	D	5,5	10,5
EWAT330B-SS(L)(R)B2	D	5,5	10,5
EWAT340B-SS(L)(R)B1	C	5,5	10,5
EWAT350B-SS(L)(R)B2	D	5,5	10,5
EWAT420B-SS(L)(R)B2	E	5,5	10,5
EWAT460B-SS(L)(R)B2	F	7,5	14,1
EWAT510B-SS(L)(R)B2	F	7,5	14,1
EWAT570B-SS(L)(R)B2	G	9,2	17,2
EWAT610B-SS(L)(R)B2	H	9,2	17,2
EWAT670B-SS(L)(R)B2	I	11	20,2

External static pressure refers to unit equipped with hydronic kit, defined as difference between pump external static pressure and evaporator pressure drop. Water flow range refer to pump only. For water flow limits of the unit refer to water flow section. To calculate the total electrical data of the base unit selected with hydronic kit, the electrical data of the pump must be added to the electrical data of the base unit. Electrical data are subject to modification without notice. Please refer to unit nameplate. Pump diagram still valid if Light Free Coling Option is selected.

**EWAT~B-S (SILVER SERIES) – Single pump high lift**

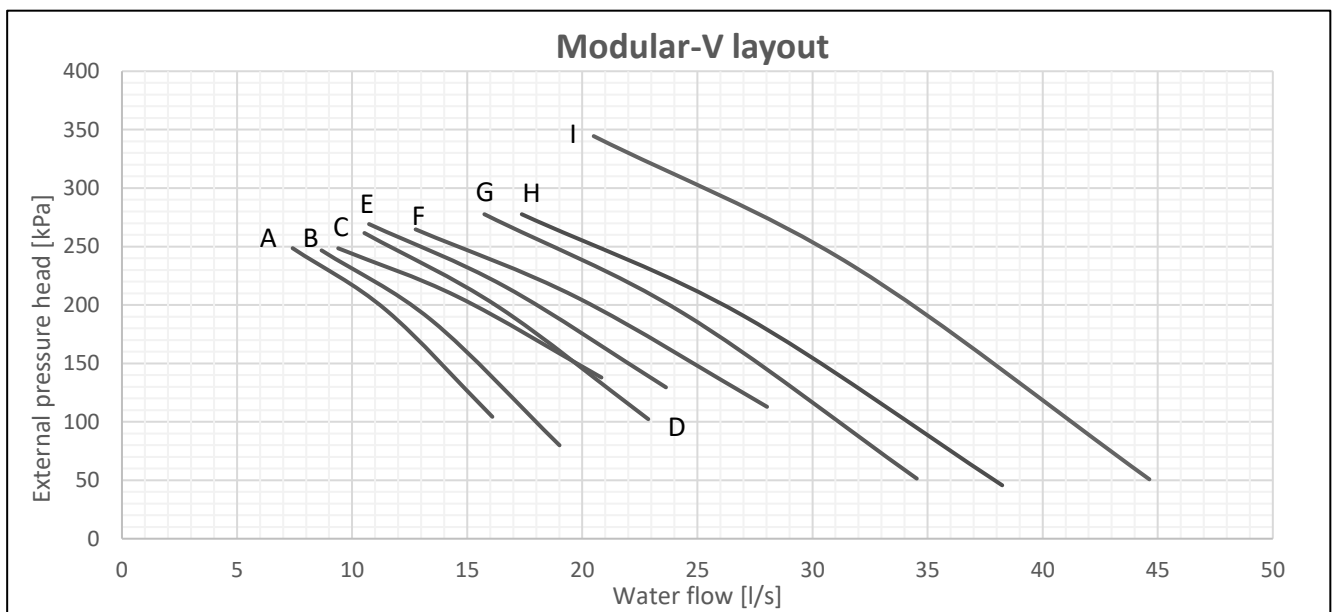
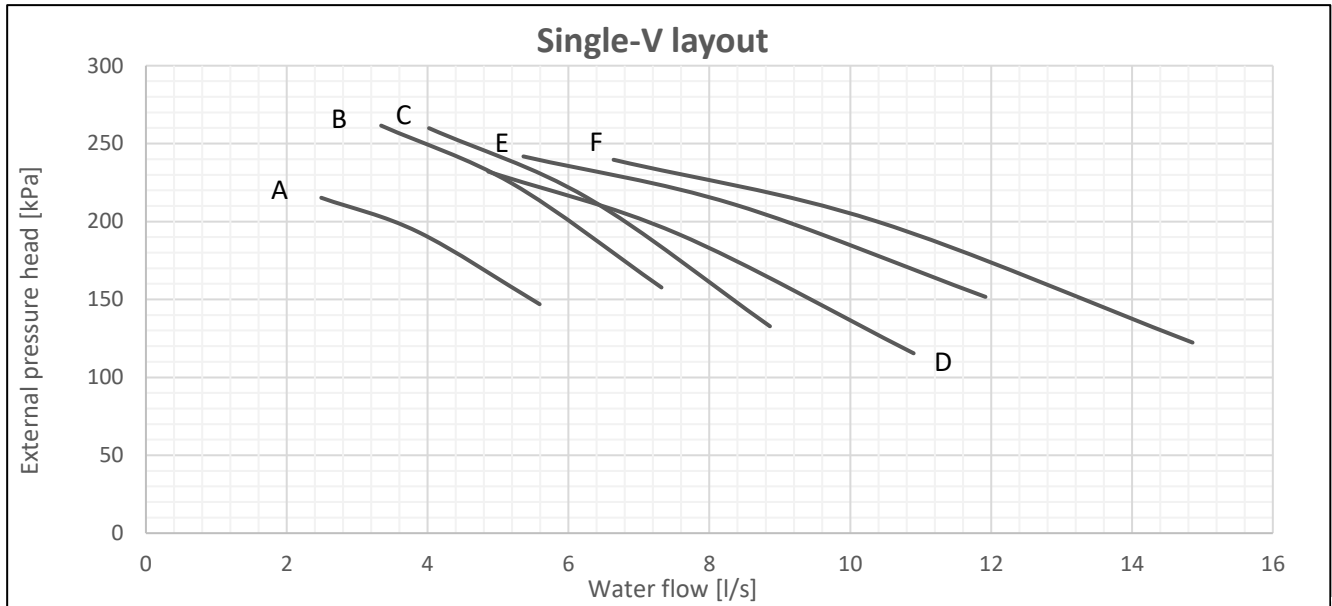

Single-V layout	Pump curve	Pump motor power [kW]	Pump motor current [A]
EWAT085B-SS(L)(R)B1	A	2,5	4,5
EWAT115B-SS(L)(R)B1	B	3,3	5,8
EWAT135B-SS(L)(R)B1	C	3,3	5,8
EWAT155B-SS(L)(R)B2	D	4,0	7,8
EWAT175B-SS(L)(R)B1	E	4,0	7,8
EWAT195B-SS(L)(R)B2	E	4,0	7,8
EWAT205B-SS(L)(R)B2	E	4,0	7,8
EWAT215B-SS(L)(R)B1	F	4,0	7,8

Modular-V layout	Pump curve	Pump motor power [kW]	Pump motor current [A]
EWAT240B-SS(L)(R)B2	A	4,0	7,6
EWAT260B-SS(L)(R)B2	A	7,5	14,1
EWAT290B-SS(L)(R)B1	B	4,0	7,6
EWAT310B-SS(L)(R)B2	C	7,5	14,1
EWAT330B-SS(L)(R)B2	C	7,5	14,1
EWAT340B-SS(L)(R)B1	D	9,2	17,2
EWAT350B-SS(L)(R)B2	E	9,2	17,2
EWAT420B-SS(L)(R)B2	F	9,2	17,2
EWAT460B-SS(L)(R)B2	G	11	20,2
EWAT510B-SS(L)(R)B2	G	11	20,2
EWAT570B-SS(L)(R)B2	H	11	20,2
EWAT610B-SS(L)(R)B2	I	15	26,6
EWAT670B-SS(L)(R)B2	I	15	26,6

External static pressure refers to unit equipped with hydronic kit, defined as difference between pump external static pressure and evaporator pressure drop. Water flow range refer to pump only. For water flow limits of the unit refer to water flow section. To calculate the total electrical data of the base unit selected with hydronic kit, the electrical data of the pump must be added to the electrical data of the base unit. Electrical data are subject to modification without notice. Please refer to unit nameplate. Pump diagram still valid if Light Free Coling Option is selected.

**EWAT~B-S (SILVER SERIES) – Twin pump low lift**

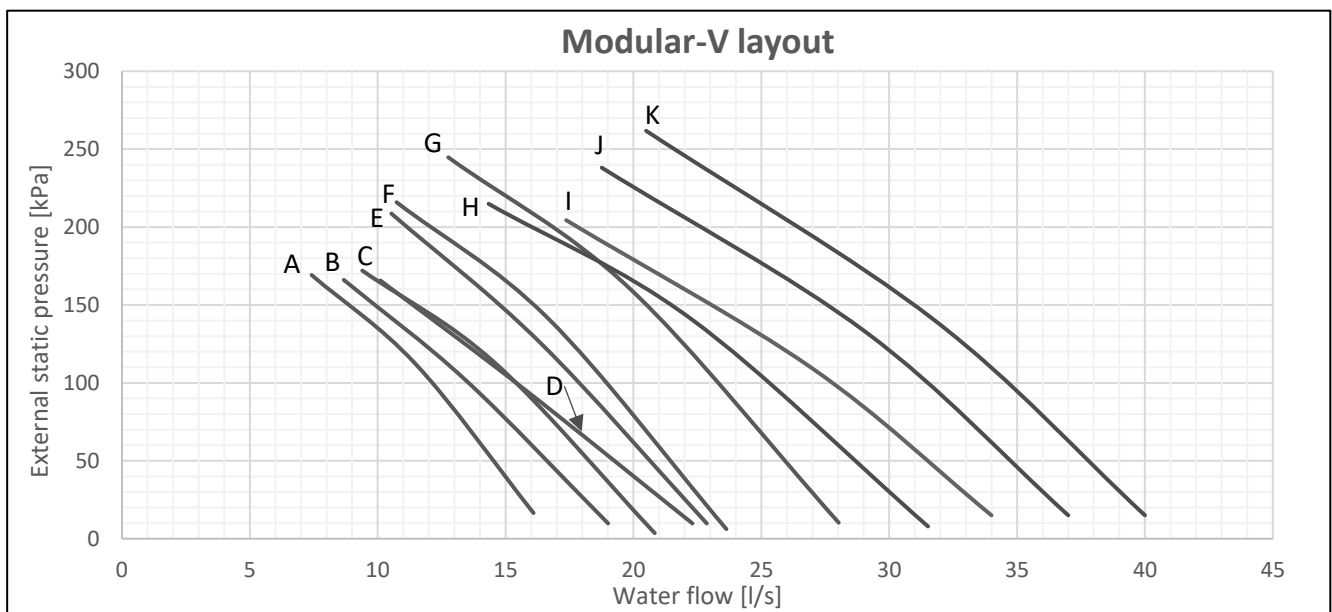
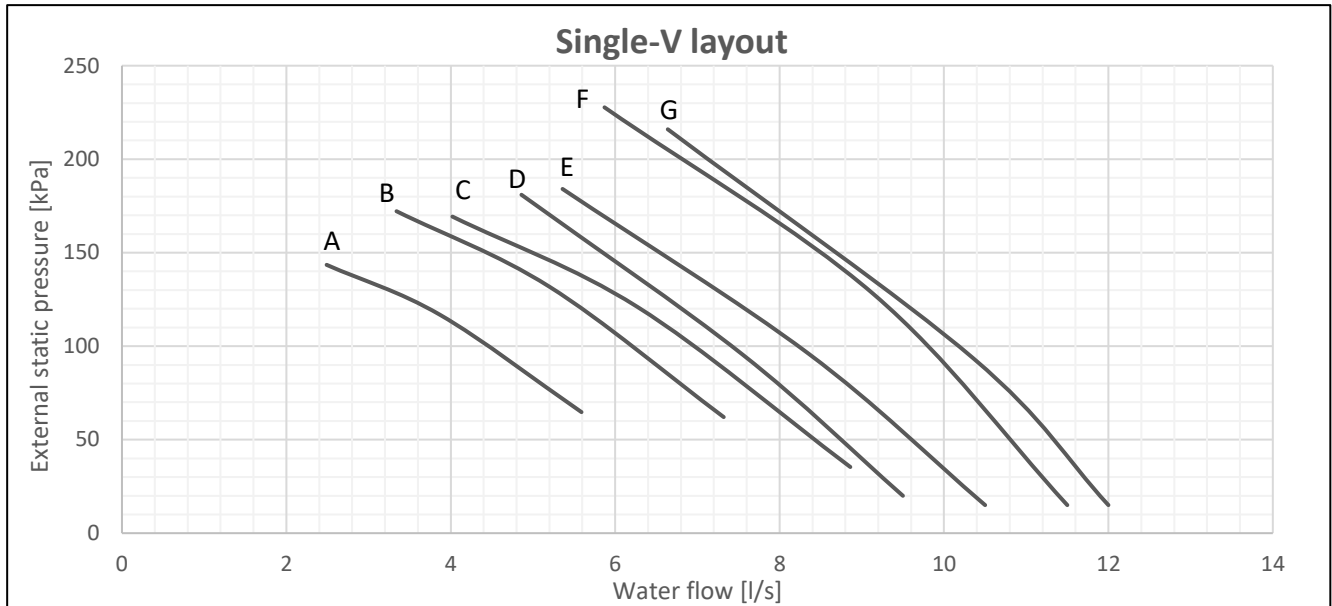

Single-V layout	Pump curve	Pump motor power [kW]	Pump motor current [A]
EWAT085B-SS(L)(R)B1	A	1,4	2,5
EWAT115B-SS(L)(R)B1	B	2,0	3,4
EWAT135B-SS(L)(R)B1	C	2,0	3,4
EWAT155B-SS(L)(R)B2	D	2,5	4,5
EWAT175B-SS(L)(R)B1	E	2,5	4,5
EWAT195B-SS(L)(R)B2	F	3,3	5,8
EWAT205B-SS(L)(R)B2	F	3,3	5,8
EWAT215B-SS(L)(R)B1	G	3,3	5,8

Modular-V layout	Pump curve	Pump motor power [kW]	Pump motor current [A]
EWAT240B-SS(L)(R)B2	A	4,0	7,6
EWAT260B-SS(L)(R)B2	A	4,0	7,6
EWAT290B-SS(L)(R)B1	B	4,0	7,6
EWAT310B-SS(L)(R)B2	C	4,0	7,6
EWAT330B-SS(L)(R)B2	D	4,0	7,6
EWAT340B-SS(L)(R)B1	E	5,5	10,5
EWAT350B-SS(L)(R)B2	F	5,5	10,5
EWAT420B-SS(L)(R)B2	G	7,5	14,1
EWAT460B-SS(L)(R)B2	H	7,5	14,1
EWAT510B-SS(L)(R)B2	H	7,5	14,1
EWAT570B-SS(L)(R)B2	I	7,5	14,1
EWAT610B-SS(L)(R)B2	J	9,2	17,2
EWAT670B-SS(L)(R)B2	K	11	20,2

External static pressure refers to unit equipped with hydronic kit, defined as difference between pump external static pressure and evaporator pressure drop. Water flow range refer to pump only. For water flow limits of the unit refer to water flow section. To calculate the total electrical data of the base unit selected with hydronic kit, the electrical data of the pump must be added to the electrical data of the base unit. Electrical data are subject to modification without notice. Please refer to unit nameplate. Pump diagram still valid if Light Free Coling Option is selected.

**EWAT~B-S (SILVER SERIES) – Twin pump high lift**

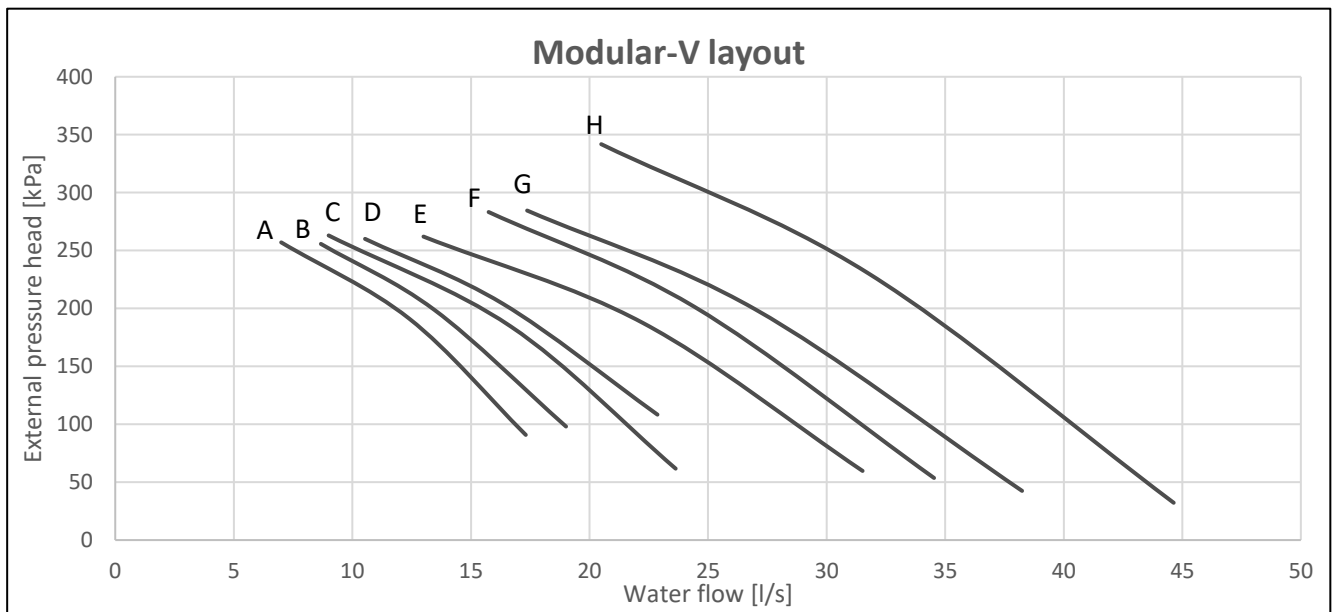
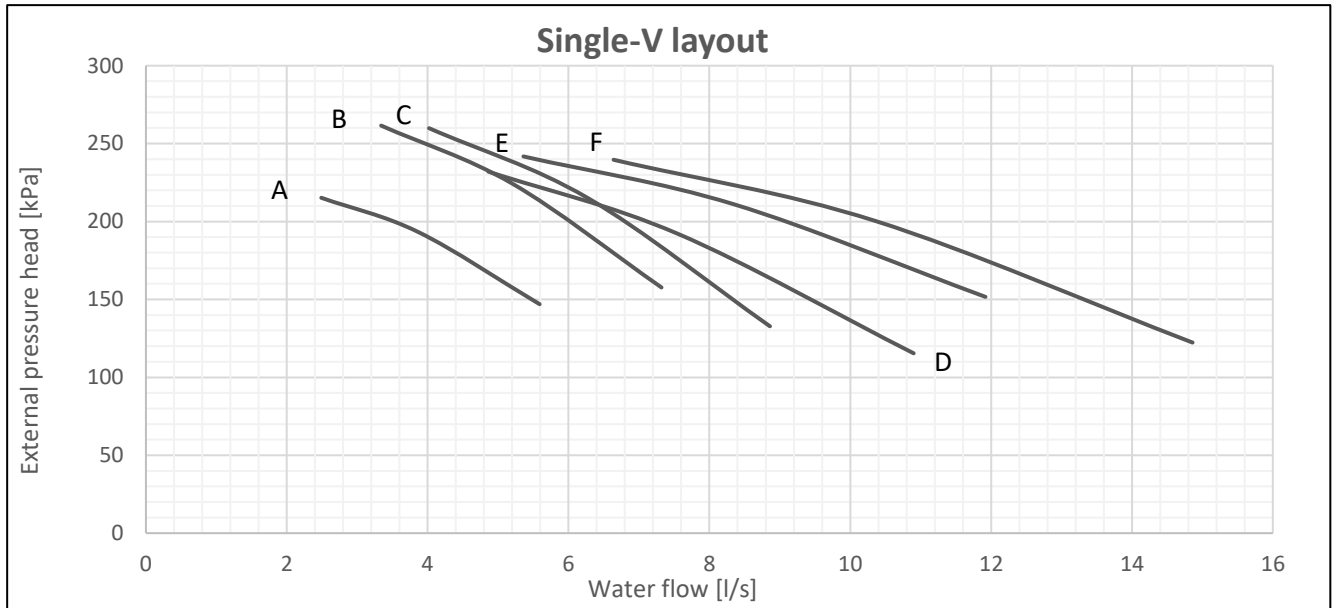

	Pump curve	Pump motor power [kW]	Pump motor current [A]
EWAT085B-SS(L)(R)B1	A	2,5	4,5
EWAT115B-SS(L)(R)B1	B	3,3	5,8
EWAT135B-SS(L)(R)B1	C	3,3	5,8
EWAT155B-SS(L)(R)B2	D	4,0	7,8
EWAT175B-SS(L)(R)B1	E	4,0	7,8
EWAT195B-SS(L)(R)B2	E	4,0	7,8
EWAT205B-SS(L)(R)B2	E	4,0	7,8
EWAT215B-SS(L)(R)B1	F	4,0	7,8

Modular-V layout	Pump curve	Pump motor power [kW]	Pump motor current [A]
EWAT240B-SS(L)(R)B2	A	7,5	14,1
EWAT260B-SS(L)(R)B2	A	7,5	14,1
EWAT290B-SS(L)(R)B1	B	7,5	14,1
EWAT310B-SS(L)(R)B2	C	7,5	14,1
EWAT330B-SS(L)(R)B2	C	7,5	14,1
EWAT340B-SS(L)(R)B1	D	9,2	17,2
EWAT350B-SS(L)(R)B2	C	7,5	14,1
EWAT420B-SS(L)(R)B2	E	9,2	17,2
EWAT460B-SS(L)(R)B2	E	9,2	17,2
EWAT510B-SS(L)(R)B2	F	11	20,2
EWAT570B-SS(L)(R)B2	G	11	20,2
EWAT610B-SS(L)(R)B2	G	11	20,2
EWAT670B-SS(L)(R)B2	H	15	26,6

External static pressure refers to unit equipped with hydronic kit, defined as difference between pump external static pressure and evaporator pressure drop. Water flow range refer to pump only. For water flow limits of the unit refer to water flow section. To calculate the total electrical data of the base unit selected with hydronic kit, the electrical data of the pump must be added to the electrical data of the base unit. Electrical data are subject to modification without notice. Please refer to unit nameplate. Pump diagram still valid if Light Free Coling Option is selected.

**EWAT~B-X (GOLD SERIES) – Single pump low lift**

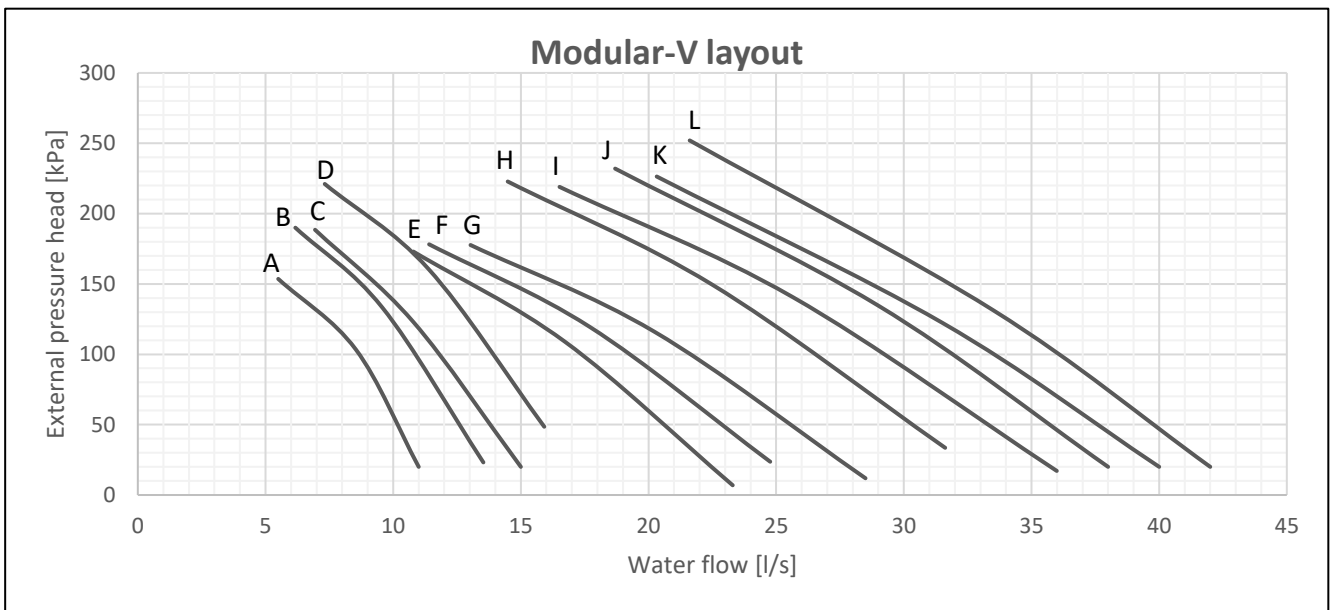
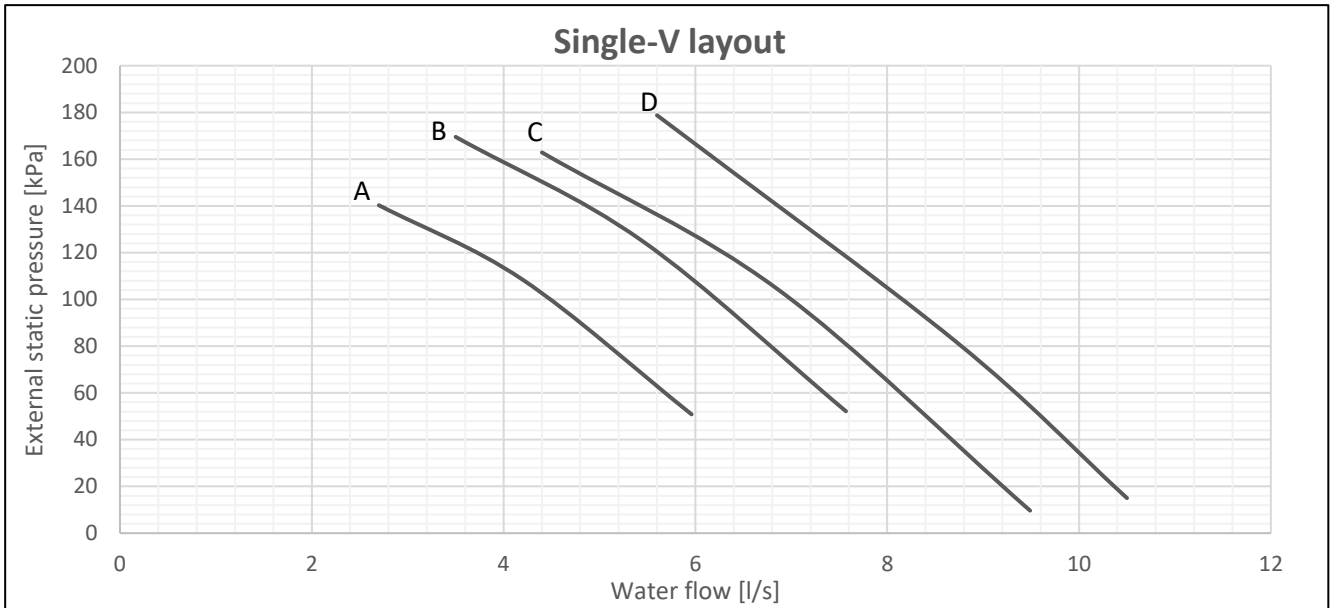

Single-V layout	Pump curve	Pump motor power [kW]	Pump motor current [A]
EWAT085B-XS(L)(R)B1	A	1,4	2,5
EWAT115B-XS(L)(R)B1	B	2,0	3,4
EWAT145B-XS(L)(R)B1	C	2,0	3,4
EWAT185B-XS(L)(R)B1	D	2,5	4,5

Modular-V layout	Pump curve	Pump motor power [kW]	Pump motor current [A]
EWAT180B-XS(L)(R)B2	A	2,2	4,5
EWAT200B-XS(L)(R)B2	B	3	6,3
EWAT220B-XS(L)(R)B2	C	3	6,3
EWAT230B-XS(L)(R)B1	D	3	6,3
EWAT250B-XS(L)(R)B2	D	4	7,6
EWAT280B-XS(L)(R)B2	F	5,5	10,5
EWAT300B-XS(L)(R)B1	E	5,5	10,5
EWAT310B-XS(L)(R)B2	F	5,5	10,5
EWAT320B-XS(L)(R)B2	F	5,5	10,5
EWAT360B-XS(L)(R)B1	E	7,5	14,1
EWAT370B-XS(L)(R)B2	F	5,5	10,5
EWAT430B-XS(L)(R)B2	G	5,5	10,5
EWAT470B-XS(L)(R)B2	H	7,5	14,1
EWAT540B-XS(L)(R)B2	I	7,5	14,1
EWAT600B-XS(L)(R)B2	J	9,2	17,2
EWAT660B-XS(L)(R)B2	K	9,2	17,2
EWAT700B-XS(L)(R)B2	L	11	20,2

External static pressure refers to unit equipped with hydronic kit, defined as difference between pump external static pressure and evaporator pressure drop. Water flow range refer to pump only. For water flow limits of the unit refer to water flow section. To calculate the total electrical data of the base unit selected with hydronic kit, the electrical data of the pump must be added to the electrical data of the base unit. Electrical data are subject to modification without notice. Please refer to unit nameplate. Pump diagram still valid if Light Free Coling Option is selected.

**EWAT~B-X (GOLD SERIES) – Single pump High lift**

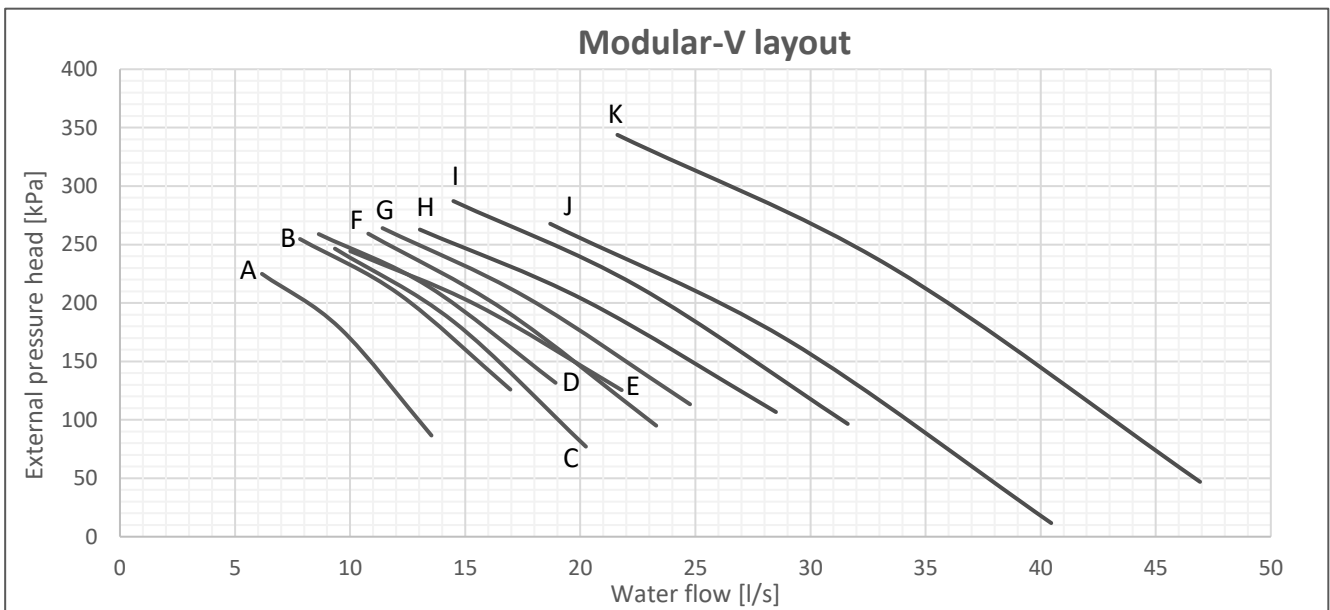
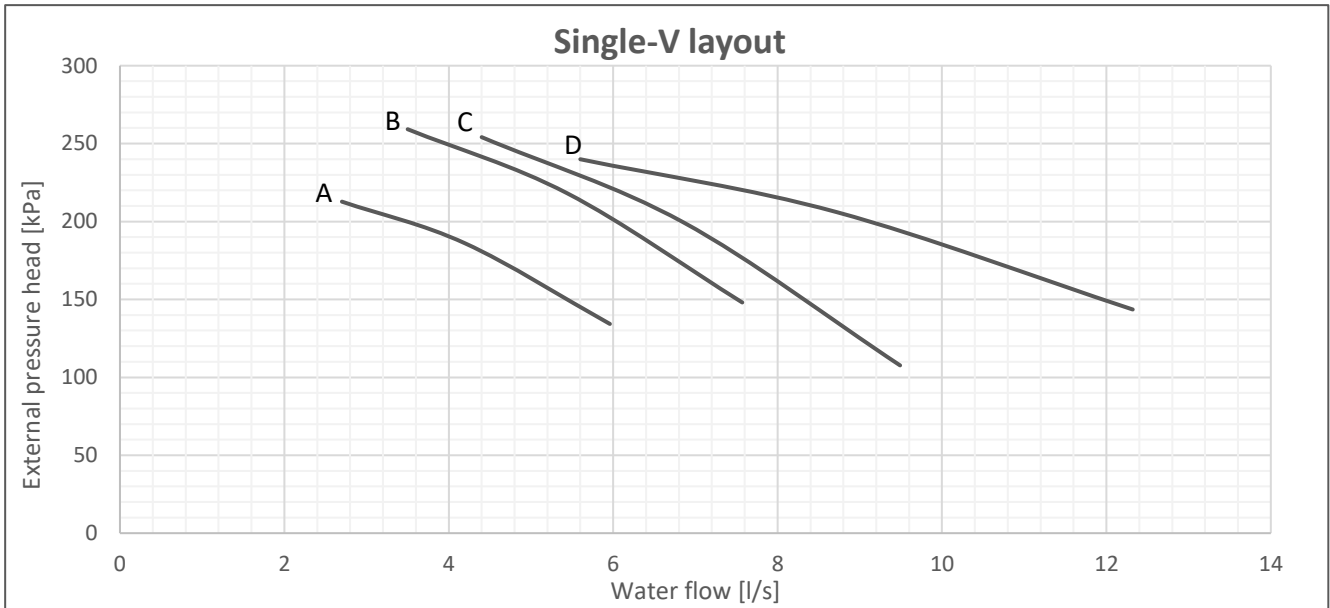

Single-V layout	Pump curve	Pump motor power [kW]	Pump motor current [A]
EWAT085B-XS(L)(R)B1	A	2,5	4,5
EWAT115B-XS(L)(R)B1	B	3,3	5,8
EWAT145B-XS(L)(R)B1	C	3,3	5,8
EWAT185B-XS(L)(R)B1	D	4,0	7,8

Modular-V layout	Pump curve	Pump motor power [kW]	Pump motor current [A]
EWAT180B-XS(L)(R)B2	A	4,0	7,6
EWAT200B-XS(L)(R)B2	A	4,0	7,6
EWAT220B-XS(L)(R)B2	B	7,5	14,1
EWAT230B-XS(L)(R)B1	B	4,0	7,6
EWAT250B-XS(L)(R)B2	B	7,5	14,1
EWAT280B-XS(L)(R)B2	D	7,5	14,1
EWAT300B-XS(L)(R)B1	C	7,5	14,1
EWAT310B-XS(L)(R)B2	E	7,5	14,1
EWAT320B-XS(L)(R)B2	E	7,5	14,1
EWAT360B-XS(L)(R)B1	F	9,2	17,2
EWAT370B-XS(L)(R)B2	G	9,2	17,2
EWAT430B-XS(L)(R)B2	H	9,2	17,2
EWAT470B-XS(L)(R)B2	I	11	20,2
EWAT540B-XS(L)(R)B2	J	11	20,2
EWAT600B-XS(L)(R)B2	J	11	20,2
EWAT660B-XS(L)(R)B2	K	15	26,6
EWAT700B-XS(L)(R)B2	K	15	26,6

External static pressure refers to unit equipped with hydronic kit, defined as difference between pump external static pressure and evaporator pressure drop. Water flow range refer to pump only. For water flow limits of the unit refer to water flow section. To calculate the total electrical data of the base unit selected with hydronic kit, the electrical data of the pump must be added to the electrical data of the base unit. Electrical data are subject to modification without notice. Please refer to unit nameplate. Pump diagram still valid if Light Free Cooling Option is selected.

**EWAT~B-X (GOLD SERIES) – Twin pump low lift**

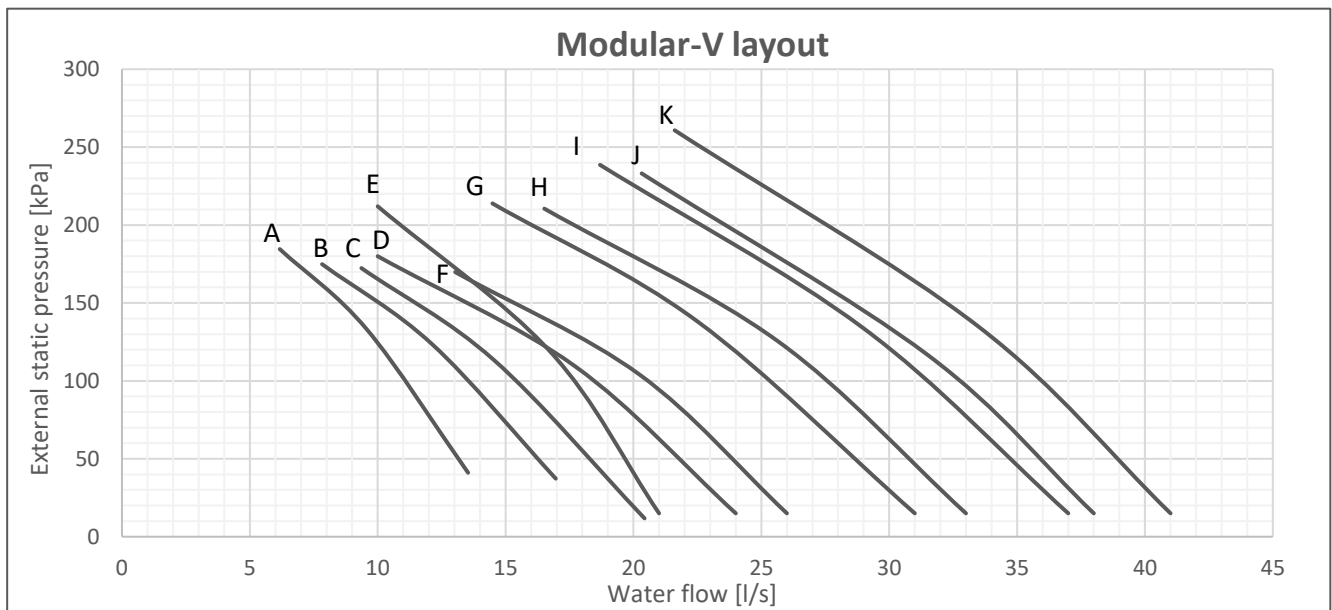
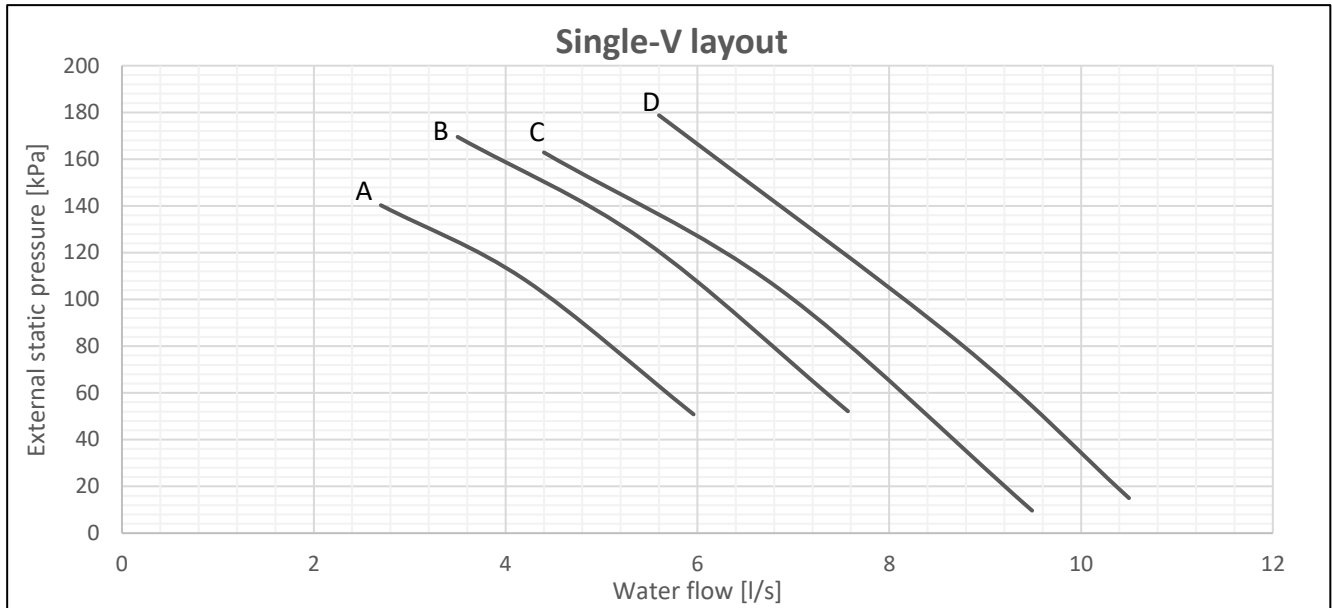

Single-V layout	Pump curve	Pump motor power [kW]	Pump motor current [A]
EWAT085B-XS(L)(R)B1	A	1,4	2,5
EWAT115B-XS(L)(R)B1	B	2,0	3,4
EWAT145B-XS(L)(R)B1	C	2,0	3,4
EWAT185B-XS(L)(R)B1	D	2,5	4,5

Modular-V layout	Pump curve	Pump motor power [kW]	Pump motor current [A]
EWAT180B-XS(L)(R)B2	A	3,0	6,3
EWAT200B-XS(L)(R)B2	A	3,0	6,3
EWAT220B-XS(L)(R)B2	B	4,0	7,6
EWAT230B-XS(L)(R)B1	B	4,0	7,6
EWAT250B-XS(L)(R)B2	B	4,0	7,6
EWAT280B-XS(L)(R)B2	C	4,0	7,6
EWAT300B-XS(L)(R)B1	E	5,5	10,5
EWAT310B-XS(L)(R)B2	C	4,0	7,6
EWAT320B-XS(L)(R)B2	D	5,5	10,5
EWAT360B-XS(L)(R)B1	E	5,5	10,5
EWAT370B-XS(L)(R)B2	D	5,5	10,5
EWAT430B-XS(L)(R)B2	F	5,5	10,5
EWAT470B-XS(L)(R)B2	G	7,5	14,1
EWAT540B-XS(L)(R)B2	H	7,5	14,1
EWAT600B-XS(L)(R)B2	I	9,2	17,2
EWAT660B-XS(L)(R)B2	J	9,2	17,2
EWAT700B-XS(L)(R)B2	K	11	20,2

External static pressure refers to unit equipped with hydronic kit, defined as difference between pump external static pressure and evaporator pressure drop. Water flow range refer to pump only. For water flow limits of the unit refer to water flow section. To calculate the total electrical data of the base unit selected with hydronic kit, the electrical data of the pump must be added to the electrical data of the base unit. Electrical data are subject to modification without notice. Please refer to unit nameplate. Pump diagram still valid if Light Free Coling Option is selected.



**EWAT~B-X (GOLD SERIES) – Twin pump High lift**

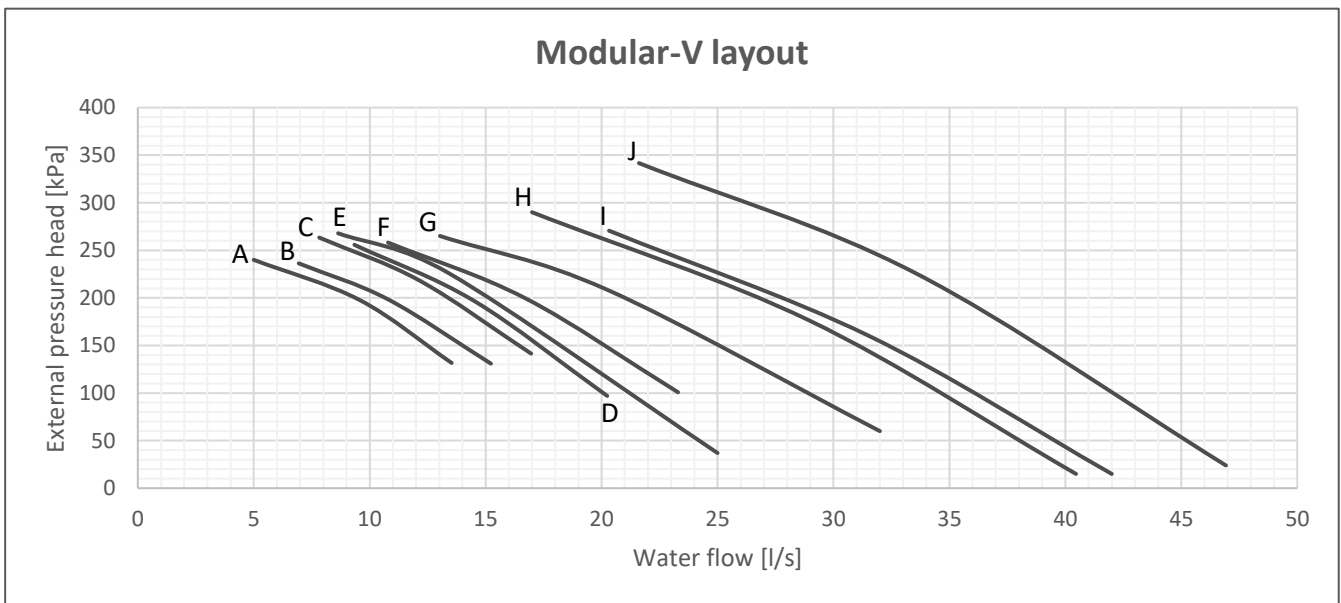
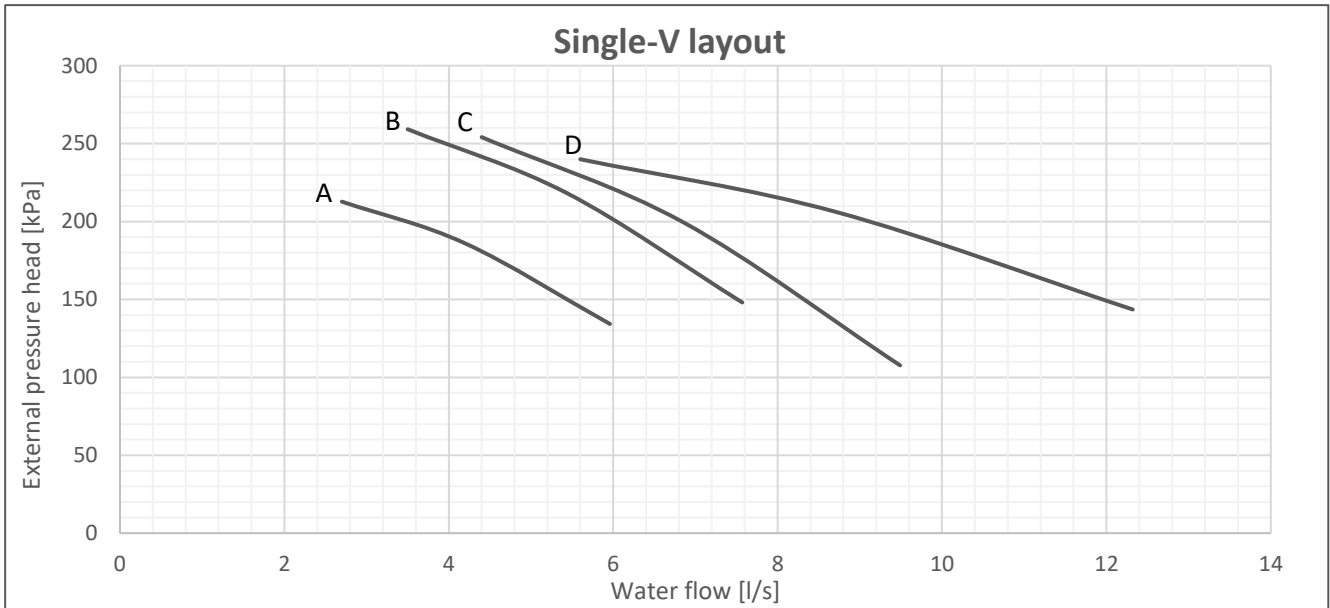

Single-V layout	Pump curve	Pump motor power [kW]	Pump motor current [A]
EWAT085B-XS(L)(R)B1	A	2,5	4,5
EWAT115B-XS(L)(R)B1	B	3,3	5,8
EWAT145B-XS(L)(R)B1	C	3,3	5,8
EWAT185B-XS(L)(R)B1	D	4,0	7,8

Modular-V layout	Pump curve	Pump motor power [kW]	Pump motor current [A]
EWAT180B-XS(L)(R)B2	A	5,5	10,5
EWAT200B-XS(L)(R)B2	A	5,5	10,5
EWAT220B-XS(L)(R)B2	B	5,5	10,5
EWAT230B-XS(L)(R)B1	C	7,5	14,1
EWAT250B-XS(L)(R)B2	C	7,5	14,1
EWAT280B-XS(L)(R)B2	E	7,5	14,1
EWAT300B-XS(L)(R)B1	D	7,5	14,1
EWAT310B-XS(L)(R)B2	E	7,5	14,1
EWAT320B-XS(L)(R)B2	E	7,5	14,1
EWAT360B-XS(L)(R)B1	F	9,2	17,2
EWAT370B-XS(L)(R)B2	E	7,5	14,1
EWAT430B-XS(L)(R)B2	G	9,2	17,2
EWAT470B-XS(L)(R)B2	G	9,2	17,2
EWAT540B-XS(L)(R)B2	H	11,0	20,2
EWAT600B-XS(L)(R)B2	H	11,0	20,2
EWAT660B-XS(L)(R)B2	I	11,0	20,2
EWAT700B-XS(L)(R)B2	J	15,0	26,6

External static pressure refers to unit equipped with hydronic kit, defined as difference between pump external static pressure and evaporator pressure drop. Water flow range refer to pump only. For water flow limits of the unit refer to water flow section. To calculate the total electrical data of the base unit selected with hydronic kit, the electrical data of the pump must be added to the electrical data of the base unit. Electrical data are subject to modification without notice. Please refer to unit nameplate. Pump diagram still valid if Light Free Coling Option is selected.

Water filter pressure drops

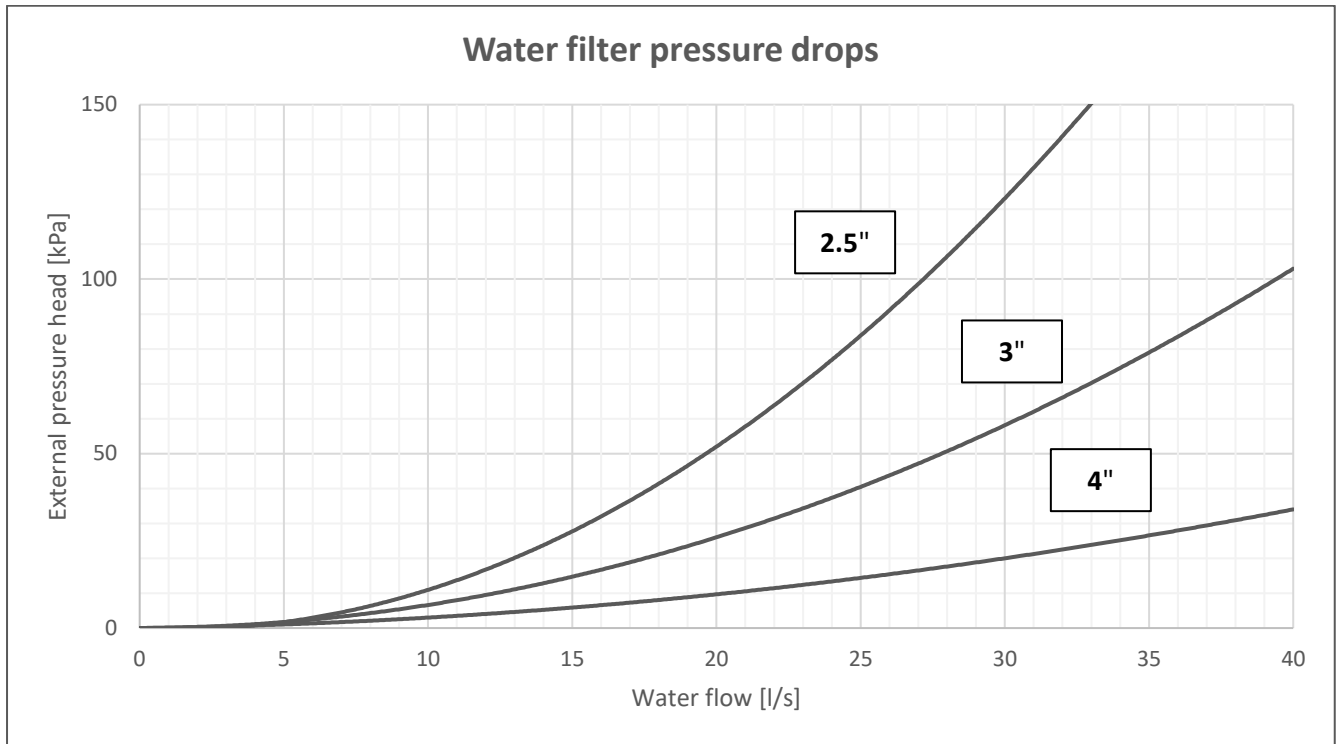

Starting current with soft starter

MODEL	LRA [A]	MODEL	LRA [A]
EWAT085B-SS(L)(R)B1	156	EWAT085B-XS(L)(R)B1	158
EWAT115B-SS(L)(R)B1	196	EWAT115B-XS(L)(R)B1	198
EWAT135B-SS(L)(R)B1	207	EWAT145B-XS(L)(R)B1	211
EWAT155B-SS(L)(R)B2	226	EWAT180B-XS(L)(R)B2	232
EWAT175B-SS(L)(R)B1	328	EWAT185B-XS(L)(R)B1	330
EWAT195B-SS(L)(R)B2	266	EWAT200B-XS(L)(R)B2	272
EWAT205B-SS(L)(R)B2	277	EWAT220B-XS(L)(R)B2	283
EWAT215B-SS(L)(R)B1	364	EWAT230B-XS(L)(R)B1	368
EWAT240B-SS(L)(R)B2	295	EWAT250B-XS(L)(R)B2	299
EWAT260B-SS(L)(R)B2	306	EWAT280B-XS(L)(R)B2	406
EWAT290B-SS(L)(R)B1	409	EWAT300B-XS(L)(R)B1	417
EWAT310B-SS(L)(R)B2	434	EWAT310B-XS(L)(R)B2	417
EWAT330B-SS(L)(R)B2	446	EWAT320B-XS(L)(R)B2	429
EWAT340B-SS(L)(R)B1	449	EWAT360B-XS(L)(R)B1	453
EWAT350B-SS(L)(R)B2	457	EWAT370B-XS(L)(R)B2	465
EWAT420B-SS(L)(R)B2	498	EWAT430B-XS(L)(R)B2	502
EWAT460B-SS(L)(R)B2	543	EWAT470B-XS(L)(R)B2	539
EWAT510B-SS(L)(R)B2	579	EWAT540B-XS(L)(R)B2	587
EWAT570B-SS(L)(R)B2	624	EWAT600B-XS(L)(R)B2	640
EWAT610B-SS(L)(R)B2	661	EWAT660B-XS(L)(R)B2	677
EWAT670B-SS(L)(R)B2	701	EWAT700B-XS(L)(R)B2	713

Tank volume (Hydronic kit with tank)

MODEL	Vol [l]	MODEL	Vol [l]
EWAT085B-SS(L)(R)B1	50	EWAT085B-XS(L)(R)B1	145
EWAT115B-SS(L)(R)B1	145	EWAT115B-XS(L)(R)B1	190
EWAT135B-SS(L)(R)B1	145	EWAT145B-XS(L)(R)B1	190
EWAT155B-SS(L)(R)B2	190	EWAT180B-XS(L)(R)B2	275
EWAT175B-SS(L)(R)B1	190	EWAT185B-XS(L)(R)B1	250
EWAT195B-SS(L)(R)B2	250	EWAT200B-XS(L)(R)B2	275
EWAT205B-SS(L)(R)B2	250	EWAT220B-XS(L)(R)B2	275
EWAT215B-SS(L)(R)B1	250	EWAT230B-XS(L)(R)B1	390
EWAT240B-SS(L)(R)B2	275	EWAT250B-XS(L)(R)B2	390
EWAT260B-SS(L)(R)B2	275	EWAT280B-XS(L)(R)B2	390
EWAT290B-SS(L)(R)B1	275	EWAT300B-XS(L)(R)B1	390
EWAT310B-SS(L)(R)B2	390	EWAT310B-XS(L)(R)B2	390
EWAT330B-SS(L)(R)B2	390	EWAT320B-XS(L)(R)B2	390
EWAT340B-SS(L)(R)B1	390	EWAT360B-XS(L)(R)B1	545
EWAT350B-SS(L)(R)B2	390	EWAT370B-XS(L)(R)B2	545
EWAT420B-SS(L)(R)B2	545	EWAT430B-XS(L)(R)B2	545
EWAT460B-SS(L)(R)B2	545	EWAT470B-XS(L)(R)B2	545
EWAT510B-SS(L)(R)B2	545	EWAT540B-XS(L)(R)B2	750
EWAT570B-SS(L)(R)B2	545	EWAT600B-XS(L)(R)B2	750
EWAT610B-SS(L)(R)B2	750	EWAT660B-XS(L)(R)B2	750
EWAT670B-SS(L)(R)B2	750	EWAT700B-XS(L)(R)B2	750

**Warning** Installation and maintenance of the unit must be performed only by qualified personnel who have knowledge with local codes and regulations and experience with this type of equipment, unit installation in places that could be considered dangerous for maintenance operations must be avoided.

**Location** The units are produced for outdoor installation on roofs, floors or below ground level on condition that the area is free from obstacles for the passage of the condenser air. The unit should be positioned on solid foundations and perfectly leveled; in the case of installation on roofs or floors, it may be advisable to arrange the use of suitable weight distribution beams. When the units are installed on the ground, a concrete base at least 250 mm wider and longer than the unit's footprint should be laid. Furthermore, this base should withstand the unit weight mentioned in the technical data table.

**Space requirements** The units are air-cooled, then it is important to respect the minimum distances which guarantee the best ventilation of the condenser coils. Limitations of space reducing the air flow could cause significant reductions in cooling capacity and an increase in electricity consumption. To determine unit placement, careful consideration must be given to assure a sufficient air flow across the condenser heat transfer surface. Two conditions must be avoided to achieve the best performance: warm air recirculation and coil starvation. Both these conditions cause an increase of condensing pressures that results in reductions in unit efficiency and capacity. Moreover, the unique microprocessor can evaluate the operating environment of the air-cooled chiller and is capable to optimize performances staying on-line during abnormal conditions. Each side of the unit must be accessible after installation for periodic service. The following pictures show you minimum recommended clearance requirements.

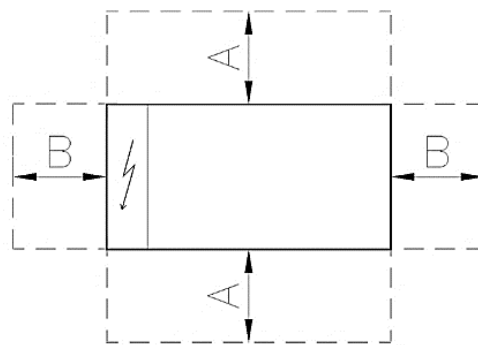

	Single V	Modular-V
A	1100 mm	2200 mm
B	1100 mm	1500 mm

For single chiller installation in proximity of a wall the following indications are recommended:

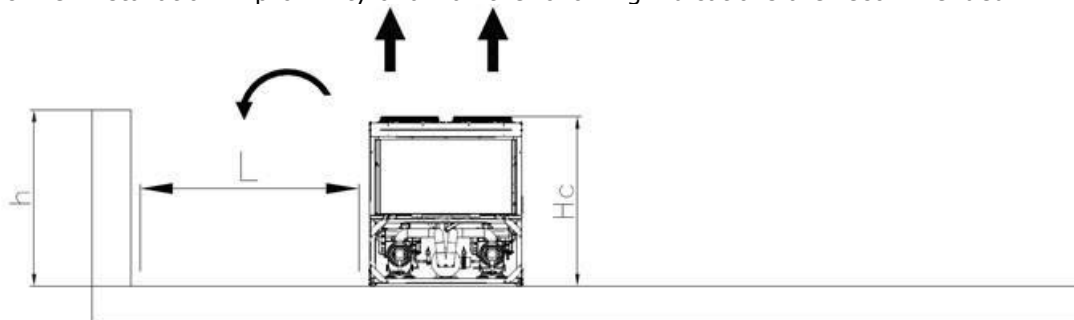

- if  $h < H_c \rightarrow L$  must be at least 3 m for Modular-V layout units or 1,8m for single-V layout units
- if  $h \geq H_c$  or  $L$  lower than recommended contact Daikin representative to evaluate possible arrangements

In case two chillers installed side by side in free filed, the minimum distance recommended between the chillers is indicated in the below picture

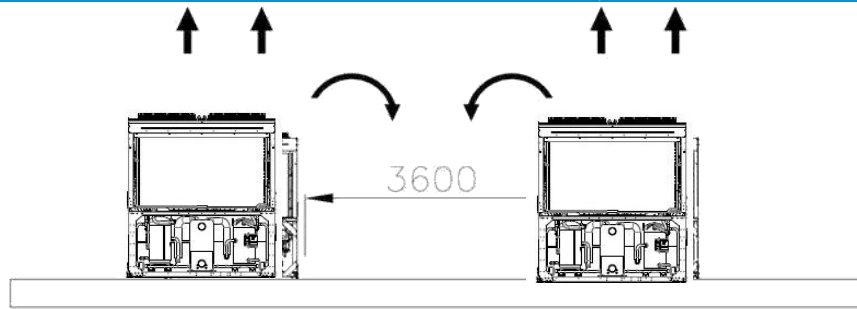

For multiple chiller installation it is recommended to install the chillers in a single row as shown in the picture below

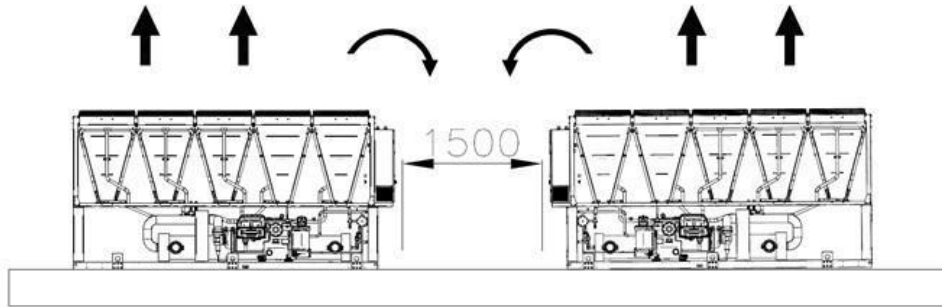

For additional information refer to the Installation Manual. If the site does not allow this kind of installation contact Daikin representative to evaluate possible arrangements.

**Multiple chillers installation – free field with wind prevalent direction**

Considering an installation in areas with prevailing wind direction (as represented in the first image below):

- Chiller n,1: operates with no air overtemperature
- Chiller n,2: operates in heated environment caused by Chiller n,1 and by itself
- Chiller n,3: operates in partially heated environment caused by Chiller n,2

To reduce the effect of prevailing wind, it is opportune to set the chillers main dimension parallel to the wind prevailing wind (as represented in the second image below).

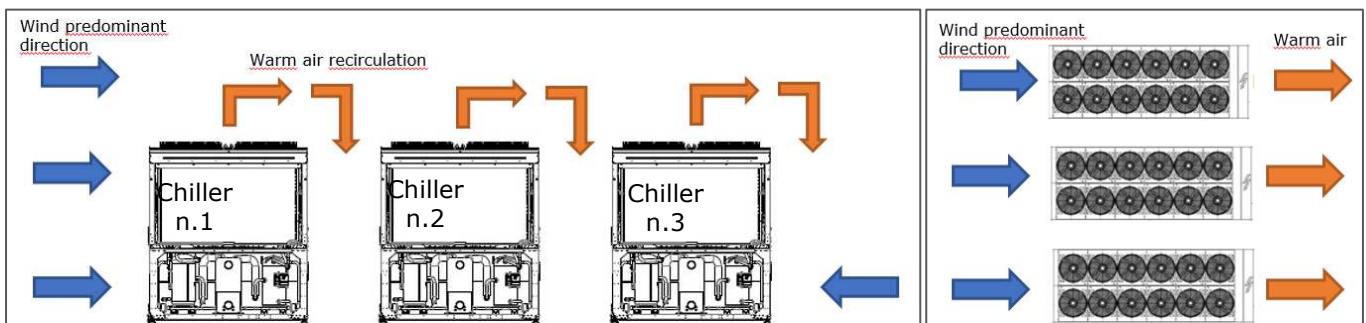

**Multiple chillers installation – closed area with wind prevalent direction**

In case of closed area with height equal or higher than the chillers, installation is not recommended. Chillers 2 and 3 operate at significantly higher temperatures due to the higher recirculation. In this case it is necessary to adopt special precautions based on the specific installation (for example: walls with grids, installation of the unit on base to increase its height, duct on fans, high head fans, etc.)

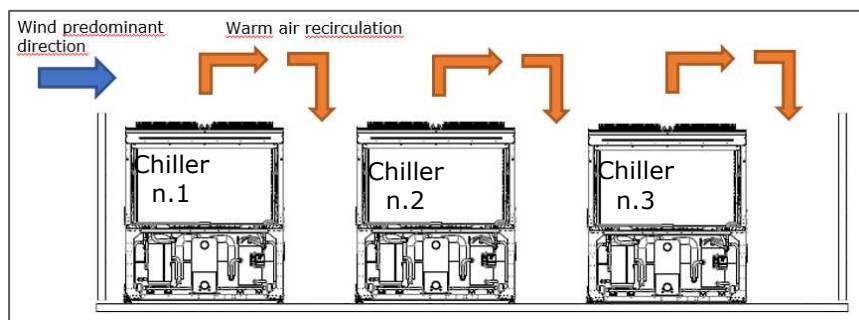

**Water filter** The installation of the filter is mandatory. Recommended maximum mesh size is equal to 1,0 mm. Water filter has to be installed as close as possible to the chiller. If the chiller is installed in a different part of the hydraulic system, the installed must ensure the cleaning of the water pipes between water filter and evaporator. The pressure drop value showed in CSS (Chiller Selection Software) are referred to chiller's evaporator only. For EWAT~B the water filter is available as option on request (shipped loose).

**Hydraulic schemes**

- **Hydraulic scheme of the Single V unit with Single Pump** (max operating pressure 6 bar)

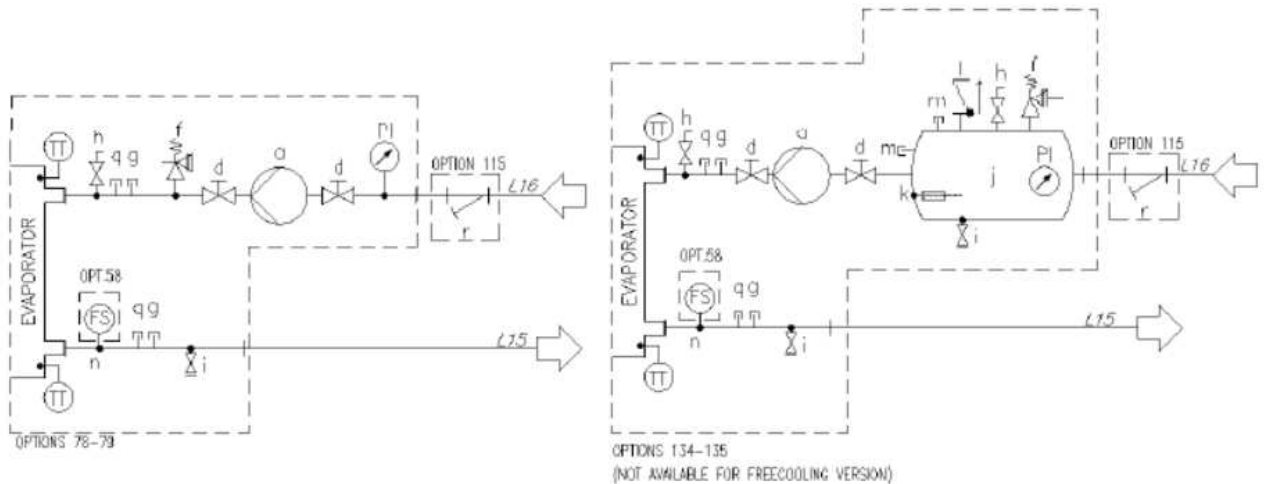

- **Hydraulic scheme of the Single V unit with Double Pump** (max operating pressure 6 bar)

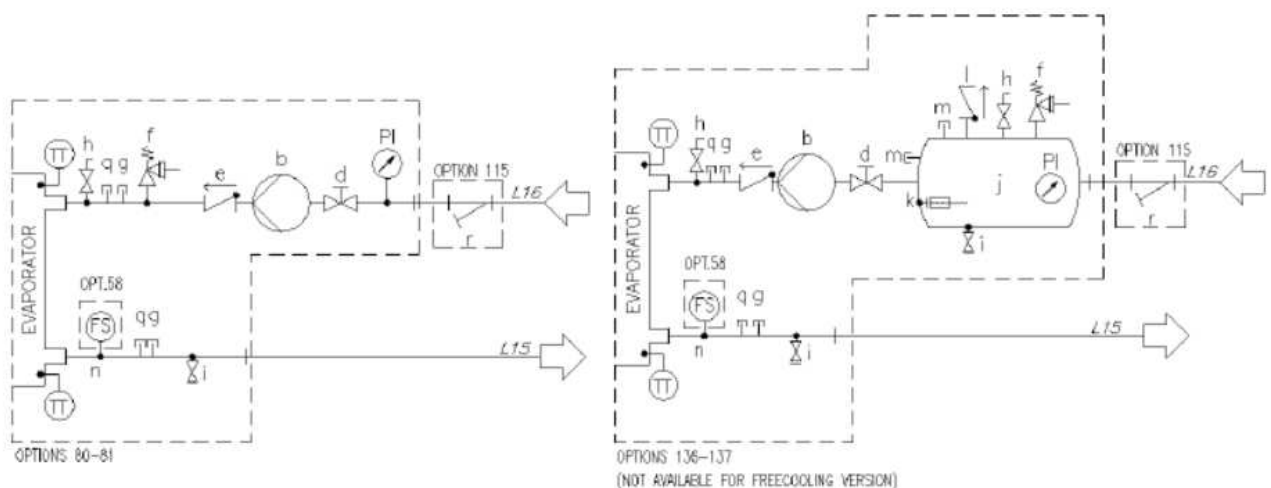

- **Hydraulic scheme of the Modular V unit with Pump(s) and tank** (max operating pressure 6 bar)

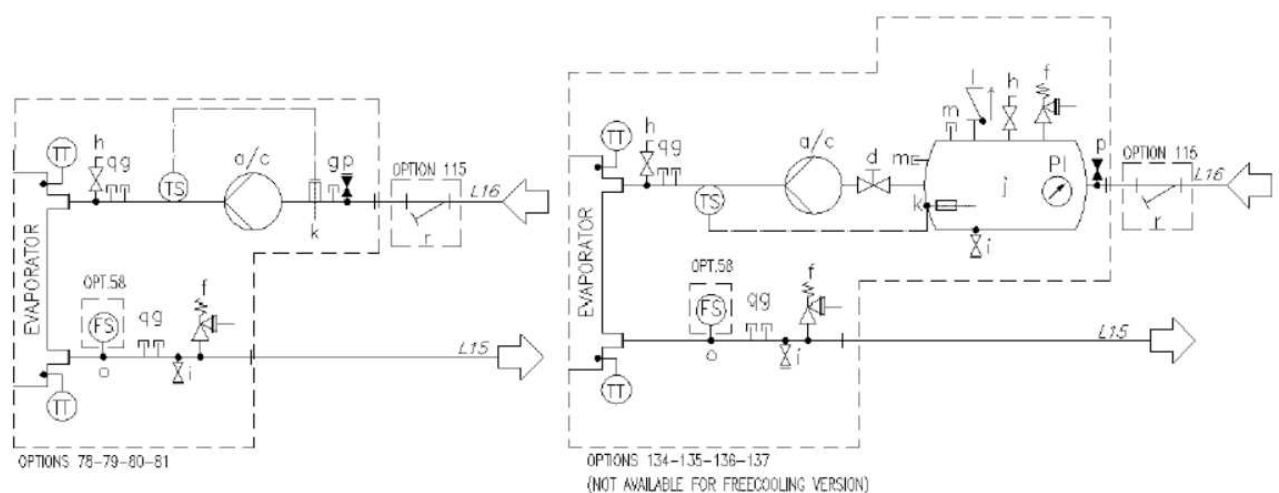

**Legend**

a	Single Pump	l	Check valve
b	Two pumps- parallel configuration	m	Plugged fitting
c	Twin pump	n	Flow switch fitting 1"
d	Valve	o	Flow switch fitting ½"
e	Check Valve	p	Automatic filling valve fitting
f	Safety Valve	q	Plugged fitting
g	Plugged fitting	r	Water filter
h	Air vent	TT	Temperature sensor
i	drain	TS	Temperature switch
j	Tank	PI	Pressure gauge
k	Electrical heater	FS	Flow switch

**General** The chiller will be designed and manufactured in accordance with the following European directives:

- Construction of pressure vessel 2014/68/EU
- Machinery Directive 2006/42/EC
- Low Voltage 2014/35/EU
- Electromagnetic Compatibility 2014/30/EU
- Harmonized standard EN 60204-1 Safety of Machinery
- Manufacturing Quality Standards UNI – UNI EN 14000

The unit will be tested at full load in the factory (at the nominal working conditions and water temperatures). The chiller will be delivered to the job site completely assembled and charged with refrigerant and oil. The installation of the chiller must comply with the manufacturer’s instructions for rigging and handling equipment.

The unit will be able to start up and operate (as standard) at full load with:

- Outside air temperature from..... °C to..... °C
- Evaporator leaving fluid temperature between..... °C and..... °C

**Refrigerant** HFC R-32

**Performance** Chiller shall supply the following performances:

- Number of chiller(s):..... unit(s)
- Cooling capacity for single chiller:..... kW
- Power input for single chiller in cooling mode:..... kW
- Heat exchanger entering water temperature in cooling mode:..... °C
- Heat exchanger leaving water temperature in cooling mode:..... °C
- Heat exchanger water flow:..... l/s
- Nominal outside working ambient temperature in cooling mode:..... °C
- Minimum full load efficiency (EER): ..... (kW/kW)
- Minimum part load efficiency (SEER): ..... (kW/kW)

Operating voltage range should be 400V ±10%, 3ph, 50Hz (or 380V ±10%, 3ph, 60Hz), voltage unbalance maximum 3%, without neutral conductor and shall only have one power connection point.

**Unit description** Chiller shall include one or two independent refrigerant circuits, hermetic orbiting scroll type optimized for R-32 operation, electronic expansion device (EEXV), direct expansion, PHE evaporator, air-cooled condenser section made with aluminum Microchannel technology, R-32 refrigerant, lubrication system, motor starting components, control system and all components necessary for a safe and stable unit operation.

The chiller will be factory assembled on a robust base frame made of galvanized steel, protected by an epoxy paint.

**Sound level and vibrations** Sound power level shall not exceed .....dB(A). The sound power levels must be rated in accordance to ISO 9614 (other types of rating cannot be used). Vibration on the base frame should not exceed 2 mm/s.

**Dimensions** Unit dimensions shall not exceed following indications:

- Unit length..... mm
- Unit width..... mm
- Unit height..... mm

**Compressors**

Hermetic orbiting scroll type optimized for R-32 operation and complete with motor over-temperature and over-current protection devices. Each compressor equipped with oil heater that keeps the oil from being diluted by the refrigerant when the chiller is not running. Each compressor is mounted on rubber antivibration mounts for a quiet operation. Unit is delivered with complete oil charge.

**Evaporator**

The units shall be equipped with a direct expansion plate to plate type evaporator

- The evaporator will be made of stainless steel brazed plates and shall be linked with an electrical heater controlled by a thermostat and shall be insulated with flexible, closed cell polyurethane insulation material
- The water connections shall be VICTAULIC type connections as standard to ensure quick mechanical disconnection between the unit and the hydronic network
- The evaporator will be manufactured in accordance to PED approval
- Flow switch on evaporator available as option (shipped loose on Modular V)
- Water filter on evaporator available as option (shipped loose)

**Condenser coil** The condenser is made entirely of aluminum with flat tubes containing small channels. Full - depth louvered aluminum fins are inserted between the tubes maximizing the heat exchange.

The Microchannel technology ensures the highest performance with the minimum surface for the exchanger. The quantity of refrigerant is also reduced compared to Cu/Al condenser, Special treatments ensure resistance to the corrosion by atmospheric agents extending the life time (available on request).

**Condenser fans** The condenser fans used in conjunction with the condenser coils, shall be propeller with glass reinforced resin blades for higher efficiencies and lower sound. Each fan shall be protected by a fan guard.

- The air discharge shall be vertical and each fan must be coupled to the electrical motor, supplied as standard to IP54 and capable to work to ambient temperatures of - 20°C to + 65°C.
- The condenser fans shall have as a standard a thermal protection by internal thermal motor.

**Refrigerant circuit** The unit shall have one or two independent refrigerant.

- The circuit shall include as standard: electronic expansion device driven by unit's microprocessor control, liquid line shut-off valve, sight glass with moisture indicator, filter drier, charging valves, high pressure switch, high and low pressure transducers, oil pressure transducer and insulated suction line, Condensation control. The units will be provided with an automatic control for condensing pressure which ensures the working at low external temperatures down to - ..... °C, to maintain condensing pressure.

- The unit automatically unloads when abnormal high condensing pressure is detected. This to prevent the shutdown of the refrigerant circuit (shutdown of the unit) due to a high-pressure fault.

The compressor shall be connected to unit's metal base frame by rubber anti vibration supports to prevent the transmission of vibrations to all metal unit structure, in order to limit the unit noise emissions. The chiller shall be provided with an acoustical compressor enclosure (according to the version). This enclosure shall be realized with a light, corrosion resisting aluminum structure and metal panels. The compressor sound-proof enclosure (available as option) shall be internally fitted with flexible, multi-layer, high density materials.

**Hydronic kit** options (on request) The hydronic module shall be integrated in the chiller chassis without increasing its dimensions and includes the following elements: centrifugal pump with motor protected by a circuit breaker installed in control panel, water filling system with pressure gauge, safety valve, drain valve,

- The hydronic module shall be assembled and wired to the control panel
- The water piping shall be protected against corrosion and freezing and insulated to prevent condensation
- A choice of two pump types shall be available:
  - in-line single pump
  - in-line twin pumps

The unit should be able to operate in Primary only system with two-ways valve on terminals with Variable Primary Flow control strategy (available as option on request).

**Master/Slave**

The unit shall be able to operate in Master / Slave mode in order to be connected with another similar unit (up to 4), The master unit shall manage the slave units connected in series on the hydraulic plant with the aim of optimize the running hours of each compressor and to balance running hours and the load between the units.

**Electrical control panel**

Power and control shall be located in the main panel that will be manufactured to ensure protection against all weather conditions.

- The electrical panel shall be IP54 and (when opening the doors) internally protected against possible
-

accidental contact with live parts

- The main panel shall be fitted with a main switch interlocked door that shuts off power supply when opening
- The power section will include compressors and fans starter devices

### Controller

The controller will be installed as standard and it will be used to modify unit set-points and check control parameters.

- A built-in display will show chiller operating status plus temperatures and pressures of water, refrigerant and air, programmable values, set-points
- A sophisticated software with predictive logic, will select the most energy efficient combination of compressors, EEXV and condenser fans to keep stable operating conditions to maximize chiller energy efficiency and reliability
- The controller will be able to protect critical components based on external signals received from the unit itself (such as motor temperatures, refrigerant gas and oil pressures, correct phase sequence, pressure switches and evaporator flow switch). The input coming from the high pressure switch cuts all digital output from the controller in less than 50ms, this will be an additional safety for the equipment.
- Fast program cycle (200ms) for a precise monitoring of the system
- Floating point calculations supported for increased accuracy in P/T conversions

### Controller features

Controller shall be guaranteed following minimum functions:

- Management of the compressors,
- Chiller enabled to work in partial failure condition
- Full routine operation at condition of:
  - high ambient temperature value
  - high thermal load
  - high evaporator entering water temperature (start-up)
- Display of evaporator entering/leaving water temperature
- Display of Outdoor Ambient Temperature
- Display of condensing-evaporating temperature and pressure, suction and discharge superheat for each circuit
- Leaving water evaporator temperature regulation
- Compressor and evaporator pumps hours counter
- Display of Status Safety Devices
- Number of starts and compressor working hours
- Optimized management of unit load
- Fan management according to condensing pressure
- Re-start in case of power failure (automatic / manual)
- Soft Load (optimized management of the unit load during the start-up)
- Start at high evaporator water temperature
- Return Reset (Set Point Reset based on return water temperature)
- OAT (Outside Ambient temperature) set-point reset
- Set point Reset from external signal (optional)
- Application and system upgrade with commercial SD cards
- Ethernet port for remote or local servicing using standard web browsers
- Master / Slave (provided as standard)
- Variable primary Flow (available as option)
- Two different sets of default parameters could be stored for easy restore

### High Level Communications Interface (on request)

The chiller shall be able to communicate to BMS (Building Management System) based on the most common protocols as:

- ModbusRTU
- LonWorks, now also based on the international 8040 Standard Chiller Profile and LonMark Technology
- BacNet BTP certified over IP





In all of us,  
a green heart



Daikin's unique position as a manufacturer of air conditioning equipment, compressors and refrigerants has led to its close involvement in environmental issues. For several years Daikin has had the intention to become a leader in the provision of products that have limited impact on the environment. This challenge demands the eco design and development of a wide range of products and an energy management system, resulting in energy conservation and a reduction of waste.



The present leaflet is drawn up by way of information only and does not constitute an offer binding upon Daikin Europe N.V. Daikin Europe N.V. has compiled the content of this leaflet to the best of its knowledge. No express or implied warranty is given for the completeness, accuracy, reliability or fitness for particular purpose of its content and the products and services presented therein. Specifications are subject to change without prior notice. Daikin Europe N.V. explicitly rejects any liability for any direct or indirect damage, in the broadest sense, arising from or related to the use and/or interpretation of this leaflet. All content is copyrighted by Daikin Europe N.V.



[www.eurovent-certification.com](http://www.eurovent-certification.com)  
[www.certiflash.com](http://www.certiflash.com)

Daikin products are distributed by: