

DAIKIN



REV	02
Date	04/2022
Supersedes	D-EIMHP01405-21_01EN

Installation, Maintenance and Operation Manual D-EIMHP01405-21_02EN

Air to water heat pump units with scroll compressors

EWYT~CZ / EWAT~CZ

Original Instruction



CONTENTS

1. INTRODUCTION	4
1.1. Precautions against residual risks	4
1.2. General description	5
1.3. Information about the refrigerant	5
1.4. Installation information	5
2. RECEIPT OF THE UNIT	6
3. STORAGE	7
4. MECHANICAL INSTALLATION	7
4.1. Safety	7
4.2. Handling and lifting	7
4.2.1. Lifting the MONO unit	7
4.2.2. Lifting the DUAL unit	8
4.3. Positioning and assembly	8
4.4. Minimum space requirements	9
4.5. Additional installation site requirements	10
4.6. Noise and acoustic protection	11
4.7. Water circuit for connection with the unit	11
4.7.1. Water piping	11
4.7.2. Flow switch	11
4.7.3. Heat recovery (optional)	12
4.7.4. Preparing and checking the water circuit connection	12
4.7.5. Water pressure	12
4.7.6. Hydraulic diagram	12
4.8. Water treatment	13
4.9. Water pressure drops for filters	13
4.10. Pump kit mounted on board (Optional)	13
4.11. Operation limits	14
4.12. Operating stability and minimum water content in the system	15
4.13. Calibrating the expansion vessel	15
4.14. Antifreeze protection for BPHE and recovery exchangers	16
5. ELECTRICAL INSTALLATION	16
5.1. General specifications	16
5.2. Electric connections	16
5.3. Cable requirements	17
5.3.1. Maximum cable dimension	17
5.3.2. Safety device requirements	17
5.4. Phase unbalance	17
6. OPERATOR'S RESPONSIBILITIES	18
7. MAINTENANCE	18
7.1. Pressure / temperature table	19
7.2. Routine maintenance	19
7.2.1. Air Heat Exchanger Maintenance	19
7.2.2. Electrical Installation	19
7.2.3. Service and limited warranty	20
7.2.4. Refrigerant circuit scheme	22
8. LIST OF THE LABELS APPLIED TO THE UNIT	26
9. COMMISSIONING	26
10. IMPORTANT INFORMATION ON THE REFRIGERANT USED	27
11. PERIODIC CHECKS AND COMMISSIONING OF PRESSURE EQUIPMENT	27
12. DISMISSION AND DISPOSAL	27

LIST OF FIGURES

Figure 1 – Lifting the MONO unit	7
Figure 2 – Lifting the DUAL unit	8
Figure 3 – MONO unit positioning	8
Figure 4 – DUAL unit positioning	8
Figure 5 – Mounting holes location (bottom view)	9
Figure 6 – DUAL unit	9
Figure 7 – Units installed side by side along their shorter sides, B or D	10
Figure 8 – Units installed side by side along their longer sides (Case 1 and Case 2)	10
Figure 9 – Seaside installation of the outdoor unit	10
Figure 10 – Hydraulic diagram	12
Figure 11 – Water filter pressure drops	13
Figure 12 – External pressure head of Low Lift Pump	13
Figure 13 – External pressure head of High Lift Pump	13
Figure 14 – Operating limits on EWATCZ	14
Figure 15 – Operating limits on EWYTCZ in cooling mode	14
Figure 16 – Operating limits on EWYTCZ in heating mode	14
Figure 17 – Minimum water volume correction factor	15
Figure 18 – Initial expansion vessel pressure on the basis of maximum water volume	15
Figure 19 – Refrigerant circuit (P&ID) diagram for MONO circuit EWYT~CZ unit	22
Figure 20 – Refrigerant circuit (P&ID) diagram for MONO circuit EWAT~CZ unit	23
Figure 21 – Refrigerant circuit (P&ID) diagram for DUAL circuit EWYT~CZ unit	24
Figure 22 – Refrigerant circuit (P&ID) diagram for DUAL circuit EWAT~CZ unit	25
Figure 23 – Labels on the unit	26

LIST OF TABLES

Table 1 – Physical properties of R32 refrigerant	5
Table 2 – Minimum glycol percentage for low ambient air temperature	11
Table 3 – Flow Switch Setpoint	12
Table 4 – Operating limits	12
Table 5 – Acceptable water quality limits	13
Table 6 – Pump curve associated with each unit size	14
Table 7 – Minimum water content in the system	15
Table 8 – Table 1 of EN602041 Point 5.2	17
Table 9 – R32 Pressure/Temperature	19
Table 10 – Standard Routine Maintenance Plan	20
Table 11 – Routine Maintenance Plan for Critical Application and/or Highly Aggressive Environment	21
Table 12 – Labels applied to the Unit	26
Table 13 – Checks before starting up the unit	26

1. INTRODUCTION

This appliance is intended to be used by expert or trained users in shops, in light industry and on farms, or for commercial use by lay persons. The appliance shall not be accessible to the general public: install it in a secured area, protected from easy access.

This manual provides information on the standard functions and procedures of all units in the series and is an important supporting document for qualified personnel but can never replace it.

All units are delivered with **wiring diagrams, certified drawings, nameplate, and CE Declaration of Conformity**. These documents show all technical data for the unit you have bought. In case of any discrepancies between the contents of the manual and the documentation provided with the unit, always rely on the unit because **it is an integral part of this manual**.

Read this manual carefully before installing and starting up the unit.

Improper installation could result in electric shock, shortcircuits, leaks, fire or other damage to the equipment or injure to people.

The unit must be installed by professional operators / technicians in compliance with the laws in force in the country of installation.

The startup of the unit must also be performed by authorized and trained personnel and all activities must be carried out in full compliance with local laws and regulations.



INSTALLATION AND START UP ARE ABSOLUTELY FORBIDDEN IF ALL INSTRUCTIONS CONTAINED IN THIS MANUAL ARE NOT CLEAR.

If you are unsure about assistance and for more information, contact an authorized representative of the manufacturer.

1.1. Precautions against residual risks

1. Install the unit according to the instructions set out in this manual.
2. Regularly carry out all the maintenance operations foreseen in this manual.
3. Wear protective equipment (gloves, goggles, helmet, etc.) suited to the work in hand; do not wear clothes or accessories that can get caught or sucked in by flows of air; tie back long hair before entering the unit.
4. Before opening the machine panel, make sure that it is firmly hinged to the machine.
5. The fins on heat exchangers and the edges of metal components and panels can cause cuts.
6. Do not remove the guards from mobile components while the unit is operating.
7. Make sure that mobile component guards are fitted correctly before restarting the unit.
8. Fans, motors and belts drives might be running: before entering, always wait for these to stop and take appropriate measures to prevent them from starting up.
9. The surfaces of the machine and pipes can get very hot or cold and cause the risk of scalding.
10. Never exceed the maximum pressure limit (PS) of the water circuit of the unit.
11. Before removing parts on the pressurized water circuits, close the section of the piping concerned and drain the fluid gradually to stabilize the pressure at the atmospheric level.
12. Do not use your hands to check possible refrigerant leaks.
13. Disable the unit from the mains using the main switch before opening the control panel.
14. Check that the unit has been grounded correctly before starting it.
15. Install the machine in a suitable area; do not install it outdoors if it is intended for use indoors.
16. Do not use cables with inadequate sections nor extension cord connections, even for very short periods or emergencies.
17. For units with VFD, wait 10 minutes after removing the electric power supply before accessing the inside of the switch board.
18. The unit contains pressurized refrigerant gas: the pressurized equipment must not be touched except during maintenance, which must be entrusted to qualified and authorized personnel.
19. Connect the utilities to the unit following the indications set out in this manual and on the panels of the unit itself.
20. To avoid an environmental risk, make sure that any leaking fluid is collected in suitable devices in accordance with local regulations.
21. If a part needs to be dismantled, make sure it is correctly reassembled before starting the unit.
22. When the rules in force require the installation of firefighting systems near the machine, check that these are suitable for extinguishing fires on electrical equipment and on the lubricating oil of the compressor and the refrigerant, as specified on the safety data sheets of these fluids.
23. Keep all the safety devices in good working order and check them periodically according to the regulations in force.
24. Keep all lubricants in suitably marked containers.
25. Do not store inflammable liquids near the unit.
26. Solder or braze only empty pipes after removing all traces of lubricant oil; do not use flames or other heat sources close to pipes containing refrigerant fluid.
27. Do not use naked flames near the unit.
28. The machinery must be installed in structures protected against atmospheric discharge according to the applicable laws and technical standards.
29. Do not bend or hit pipes containing pressurized fluids.
30. It is not permitted to walk or rest other objects on the machines.
31. The user is responsible for overall evaluation of the risk of fire in the place of installation (for example, calculation of the fire load).
32. During transport, always secure the unit to the bed of the vehicle to prevent it from moving about and overturning.
33. The machine must be transported according to the regulations in force considering the characteristics of the fluids in the machine and the description of these on the safety data sheet.
34. Inappropriate transport can cause damage to the machine and even leaking of the refrigerant fluid. Before start up, the machine must be checked for leaks and repaired accordingly.
35. The accidental discharge of refrigerant in a closed area can cause a lack of oxygen and, therefore, the risk of asphyxiation: install the machinery in a wellventilated environment according to EN 378-3 / ISO 5149-3 and the local regulations in force.
36. The installation must comply with the requirements of EN 378-3 / ISO 5149-3 and the local regulations in force.

1.2. General description

All EWYT~CZ / EWAT~CZ machines are built in accordance with the main European Directives (Machinery Directive, Low Voltage Directive, Electromagnetic Compatibility Directive, Pressure Equipment Directive).

The unit purchased is a Heat Pump, that is a machine designed to cool/heat the water (or a water-glycol mixture) within certain limits which will be listed below. The unit operates based on the compression, condensation and evaporation of the coolant gas as per the Carnot cycle, and is composed mainly of the following parts depending on the Mode of Operation.

Cooling or Conditioning Mode:

- One or more scroll compressors which increase the pressure of the refrigerant gas from evaporation pressure to condensation pressure.
- A condenser where the refrigerant gas condenses under high pressure and transfers heat to the air.
- An expansion valve which allows the pressure of condensed liquid refrigerant to be reduced from condensation pressure to evaporation pressure.
- An evaporator, where the low-pressure liquid refrigerant evaporates and chills the water.

Heating Mode or Heat Pump:

- One or more scroll compressors which increase the pressure of the refrigerant gas from evaporation pressure to condensation pressure.
- A condenser where the refrigerant gas condenses under high pressure and transfers heat to the water.
- An expansion valve which allows the pressure of condensed liquid refrigerant to be reduced from condensation pressure to evaporation pressure.
- An evaporator, where the low-pressure liquid refrigerant evaporates.
- The operation of the heat exchangers can be inverted using the 4way valve, with which the use of the heating/cooling unit can be seasonally inverted.

All units are fully assembled in the factory and tested before shipping. The EWYT~CZ / EWAT~CZ range consists of models with a single cooling circuit and models with two cooling circuits.

The machine uses R32 refrigerant fluid suitable for the entire field of application of the machine.

The controller is prewired, set up and tested at the factory. Only normal field connections such as piping, electrical connections and pump interlocks are required, simplifying installation and increasing reliability. All safety and operation control systems are installed at the factory in the control panel.

The instructions in this manual are applicable to all models in this series unless otherwise specified.

1.3. Information about the refrigerant

This product contains R32 refrigerant that has a minimal environmental impact, thanks to its low value of Global Warming Potential (GWP). According to ISO 817, R32 refrigerant is classified as A2L, which is slightly flammable, since the flame propagation rate is low, and nontoxic.

R32 refrigerant can burn slowly when all the following conditions are present:

- The concentration is between the lower and upper flammability limit (LFL & UFL).
- Wind velocity < propagation of flame velocity
- Energy of the ignition source > Minimum ignition energy

But pose no risk under the normal usage conditions for airconditioning equipment and work environment.

Safety class (ISO 817)	A2L
PED Group	1
Practical limit (kg/m³)	0.061
ATEL/ ODL (kg/m³)	0.30
LFL (kg/m³) @ 60°C	0.307
Vapor density @25°C, 101.3 kPa (kg/m³)	2.13
Molecular mass	52.0
Boiling point (°C)	-52
GWP (100 yr ITH)	675
GWP (ARS 100 yr ITH)	677
Autoignition temperature (°C)	648

Table 1 – Physical properties of R32 refrigerant

1.4. Installation information

The heat pump must be installed in open air or machinery room (location classification III).

To ensure location classification III a mechanical vent on the secondary circuit(s) must be installed.

Local building codes and safety standards shall be followed; in absence of local codes and standards refer to EN 378 3 / ISO 5149-3 as a guide.

In paragraph “Additional guidelines for safe use of R32” there are provided additional information that should be added to the requirements of safety standards and building codes.

Additional guidelines for safe use of R32 for equipment located in the open air

Units sited in the open air shall be positioned to avoid leaked refrigerant flowing into a building or otherwise endangering people and property.

The refrigerant shall not be able to flow into any ventilation fresh air opening, doorway, trap door or similar opening in the event of a leak. Where a shelter is provided for refrigerating equipment sited in the open air it shall have natural or forced ventilation.

For units installed outside in a location where a release of refrigerant can stagnate e.g. below ground, then the installation shall comply with the requirements for gas detection and ventilation of machinery rooms.

Additional guidelines for safe use of R32 for equipment located in a machinery room

When a machinery room is chosen for the location of the unit it shall be in accordance with local and national regulations. The following requirements (according to EN 378-3:2016) can be used for the assessment.

- A risk analysis based on the safety principle for a refrigeration system (as determined by the manufacturer and including the charge and safety classification of the used refrigerant) should be conducted to determine if it is necessary to install the heat pump in a separate refrigeration machinery room.
- Machinery rooms should not be used as occupied spaces. The building owner or user shall ensure that access is permitted only by qualified and trained personnel doing the necessary maintenance to the machinery room or general plant.
- Machinery rooms shall not be used for storage except for tools, spare parts and compressor oil for the installed equipment. Any

refrigerants, or flammable or toxic materials shall be stored as required by national regulations.

- Open (naked) flames shall not be permitted in machinery rooms, except for welding, brazing or similar activity and then only provided the refrigerant concentration is monitored and adequate ventilation is ensured. Such open flames shall not be left unattended.
- A remote switching (emergency type) for stopping the refrigerating system shall be provided outside the room (near the door). A similar acting switch shall be located at a suitable location inside the room.
- All piping and ducting passing through floors, ceiling and walls of machinery room shall be sealed.
- Hot surfaces shall not exceed a temperature of 80 % of the auto-ignition temperature (in °C) or 100 K less than the autoignition temperature of the refrigerant, whichever is lower.

Refrigerant	Self ignition temperature	Maximum surface temperature
R32	648°C	548°C

- Machinery rooms shall have doors opening outward and sufficient in number to ensure freedom for persons to escape in an emergency; the doors shall be tight fitting, selfclosing and so designed that they can be opened from inside (antipanic system).
- Special machinery rooms where the refrigerant charge is above the practical limit for the volume of the room shall have a door that either opens directly to the outside air or through a dedicated vestibule equipped with selfclosing, tightfitting doors.
- The ventilation of machinery rooms shall be enough both for normal operating conditions and emergencies.
- Ventilation for normal operating conditions shall be in accordance with national regulations.
- The emergency mechanical ventilation system shall be activated by a detector(s), located in the machinery room.
 - This ventilation system must be:
 - Independent of any other ventilation system on the site.
 - Provided with two independent emergency controls one located outside the machinery room, and the other inside.
 - The emergency exhaust ventilation fan shall:
 - Be either in the air flow with the motor outside the airflow or rated for hazardous areas (according to the assessment).
 - Be located to avoid pressurization of the exhaust ductwork in the machinery room.
 - Not cause sparks to occur if it contacts the duct material.
- Airflow of the emergency mechanical ventilation shall be at least:

$$V = 0.014 \times m^{2/3}$$

Where

- V is air flow in m³/s;
- m is the amount of refrigerant present in the machine room, in kg;
- 0.014 is a conversion factor.

- Mechanical ventilation shall be operated continuously or shall be switched on by the detector.
- Detector shall automatically activate an alarm, start mechanical ventilation and stop the system when it triggers
- The location of detectors shall be chosen in relation to the refrigerant and they shall be located where the refrigerant from the leak will concentrate
- The positioning of the detector shall be done with due consideration of local airflow patterns, accounting for location sources of ventilation and louvers. Consideration shall also be given to the possibility of mechanical damage or contamination.
- At least one detector shall be installed in each machinery room or the occupied space being considered and/or at the lowest underground room for refrigerants heavier than air and at the highest point for refrigerants lighter than air.

- Detectors shall be continuously monitored for functioning. In the case of a detector failure, the emergency sequence should be activated as if refrigerant had been detected.
- The preset value for the refrigerant detector at 30 °C or 0 °C, whichever is more critical, shall be set to 25 % of the LFL. The detector shall continue to activate at higher concentrations.

Refrigerant	LFL	Threshold level	
R32	0.307 kg/m ³	0.7675 kg/m ³	36000 ppm

- All electrical equipment (not only the refrigerating system) shall be selected to be suitable for use in the zones identified in the risk assessment. Electrical equipment shall be deemed to comply with the requirements if the electrical supply is isolated when the refrigerant concentration reaches 25% of the lower flammable limit or less.
- Machinery rooms or special machinery rooms shall be **clearly marked** as such on the entrances to the room, together with warning notices indicating that unauthorized persons shall not enter and that smoking, naked light or flames are prohibited. The notices shall also state that, in the event of an emergency, only authorized persons conversant with emergency procedures shall decide whether to enter the machinery room. Additionally, warning notices shall be displayed prohibiting unauthorized operation of the system
- The owner / operator shall keep an updated logbook of the refrigerating system.

2. RECEIPT OF THE UNIT

Inspect the unit immediately after delivery. Make sure that the machine is intact in all its parts and that there are no deformations due to impacts. All components described in the delivery note must be inspected and checked.

Should any damage occur upon receipt of the machine, do not remove the damaged material and immediately make a written complaint to the transport company, requesting the inspection of the unit; do not repair until inspection by the transport company representative is carried out.

Immediately report the damage to the manufacturer representative, a set of photographs is helpful in recognizing responsibility. The restitution of the machinery is intended as ex-factory Daikin Applied Europe S.p.A..

Daikin Applied Europe S.p.A. declines all responsibility for any damage that the machinery may suffer during transport to the destination.

Use extreme caution when handling the unit to prevent damage to components. Before installing the unit, check that the model and power supply voltage shown on the nameplate are correct. Responsibility for any damage after acceptance of the unit cannot be attributed to the manufacturer.

3. STORAGE

If it is necessary to store the unit before installation, it is necessary to observe some precautions:

- do not remove the protective plastic;
- protect the unit from dust, bad weather and any rodents;
- do not expose the unit to direct sunlight;
- do not use heat sources and / or open flames near the machine.

Although the unit is covered with a heatshrink plastic sheet, it is not intended for longterm storage and must be removed and replaced by tarpaulins or the like, more suitable for a longer period.

Environmental conditions must be within the following limits:

- Minimum ambient temperature: -20 °C
- Maximum ambient temperature: +48 °C
- Maximum R.H.: 95% not condensing

Storage at a temperature below the minimum or over the maximum values can cause damage to the components. Storage in a humid atmosphere may damage electrical components.

4. MECHANICAL INSTALLATION

4.1. Safety

Before installation and commissioning of the machinery, the people involved in this activity must have acquired the information necessary to perform these tasks, applying all the information gathered in this manual. In particular:

- the unit must be firmly anchored to the ground when it must not be moved;
- the unit can only be lifted using the lifting points indicated by labels fixed to its base;
- always protect operating personnel with personal protective equipment appropriate to the activities to be performed. The individual devices commonly used are: helmet, glasses, gloves, headphones, safety shoes. Further personal and collective protection devices must be adopted after having carried out an adequate analysis of the specific risks in the relevant area, according to the activities to be carried out.

4.2. Handling and lifting

Avoid bumping and/or jolting during loading/unloading unit from the truck and moving it. Do not push or pull the unit from any part other than the base frame. Secure the unit inside the truck to prevent it from moving and causing damages. Do not allow any part of the unit to fall during transportation or loading/unloading.

Lifting instructions:

Equipment, ropes, lifting accessories and handling procedures must comply with local regulations and current legislation.

When lifting the machine, use only the holes in the frame identified in the figure. Use lifting hooks with closing device exclusively. The hooks must be safely fastened before performing the handling.

The ropes and hooks used must have an appropriate capacity for the load. Refer to the plate on the unit for the weight of the specific machine.

Lifting ropes must have the minimum length shown in the diagram. All units of the series are supplied with lifting points indicated by labels. Only these points may be used for lifting the unit, as shown in the following figures.

The installer has the responsibility to ensure the selection and correct use of the lifting equipment.

Alternatively, the machine may be moved with a forklift, as shown. When lifting the machine, make sure it is levelled properly so it will not overturn.

4.2.1. Lifting the MONO unit

The machine must be lifted slowly and well levelled. Always use protective devices to prevent damage to the belt and note the position of the unit's centre of gravity. Adjust the lifting equipment if necessary to ensure that the unit is levelled.

The unit(s)- both Mono and Dual- can be lifted, using the buttonholes in the base, by:

- lifting straps
- forklift, where the dimensions of the forks permit.

N.B.: Follow the lifting instructions provided in the ID plate fastened to the electrical panel.

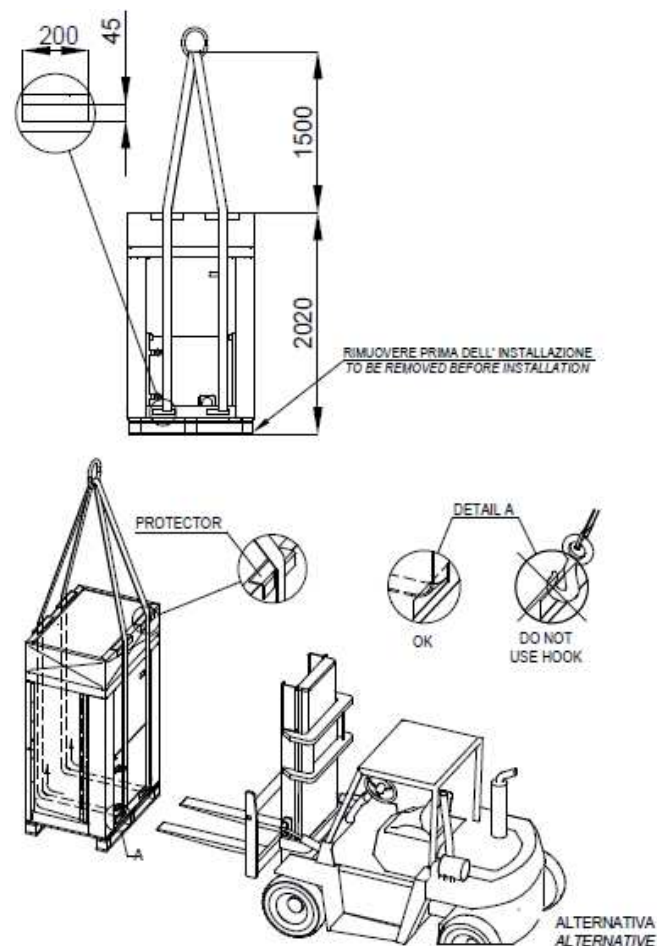

Figure 1 – Lifting the MONO unit

4.2.2. Lifting the DUAL unit

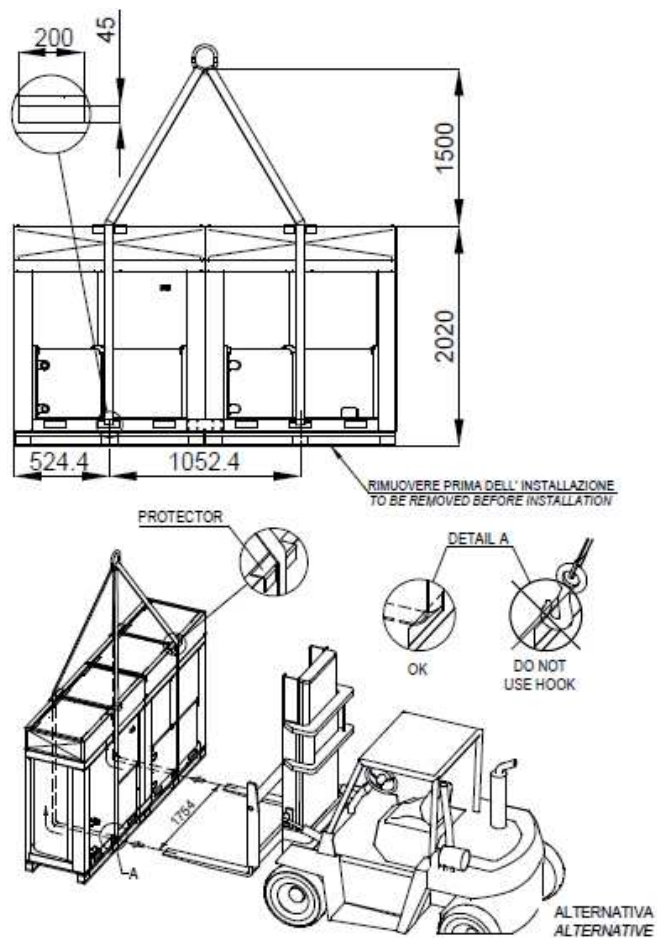

Figure 2 – Lifting the DUAL unit

4.3. Positioning and assembly

All units are designed for installation outdoors, either on balconies or on the ground, provided that the installation area is free of obstacles that could reduce air flow to the condensers coil.

The unit must be installed on a robust and perfectly level foundation; should the unit be installed on balconies or roofs, it might be necessary to use weight distribution beams.

For installation on the ground, a strong concrete base, at least 150 mm thickness and wider than the unit must be provided. This base must be able to support the weight of the unit. In heavy snowfall areas, this thickness should be increased.

The frame of the unit must be levelled using metal plate spaces.

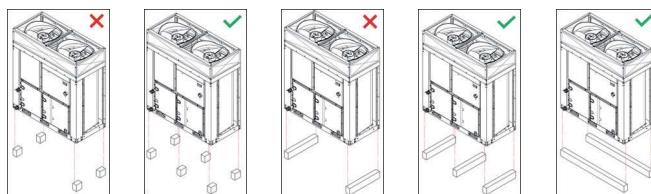

Figure 3 – MONO unit positioning

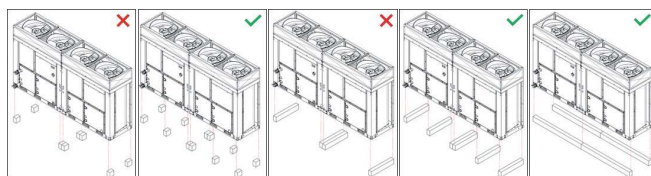

Figure 4 – DUAL unit positioning

The base can be installed both longitudinally or transversely. In the following figures are illustrated the mounting holes location:

DISPOSIZIONE FORI MONTAGGIO (VISTA DAL BASSO)
MOUNTING HOLES LOCATION (BOTTOM VIEW)

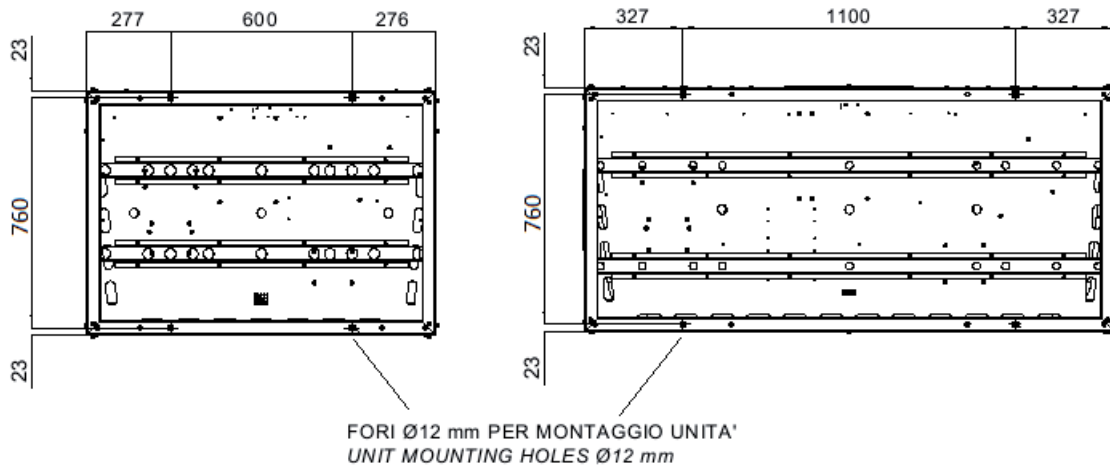

Figure 5 – Mounting holes location (bottom view)

Before unit commissioning, the flatness must be verified by using a laser levelling device or other similar devices. The flatness shall not be over 5 mm for units within 7 m length.

To ensure best performance on the installation site, the following precautions and instructions must be followed:

- Avoid air flow recirculation;
- Make sure that there are no obstacles to hamper air flow;
- Make sure to provide a strong and solid foundation to reduce noise and vibrations;
- Avoid installation in particularly dusty environments, in order to reduce soiling of condensers coils.

4.4. Minimum space requirements

It is fundamental to respect minimum distances on all units to ensure optimum ventilation to the condenser coils.

When deciding where to position the unit and to ensure a proper air flow, the following factors must be taken into consideration:

- avoid any warm air recirculation;
- avoid insufficient air supply to the aircooled condenser.

Both these conditions can cause an increase of condensing pressure, which leads to a reduction in energy efficiency and refrigerating capacity.

Any side of the unit must be accessible for postinstallation maintenance operations and vertical air discharge must not be obstructed. Figure below shows the minimum space required.

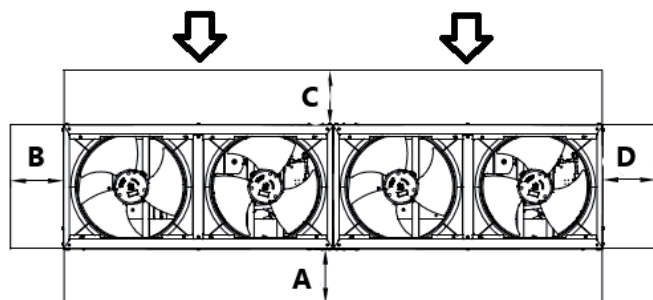

Figure 6 – DUAL unit

Where:

- A** : Electrical panel side
- B/D** : Side view of battery
- C** : Front view of battery
- ↓ : Intake

If the unit is installed in a free field, the distances indicated are:

$$A/B/C/D \geq 500 \text{ mm}$$

In the presence of obstacles or walls, the following minimum distances are recommended:

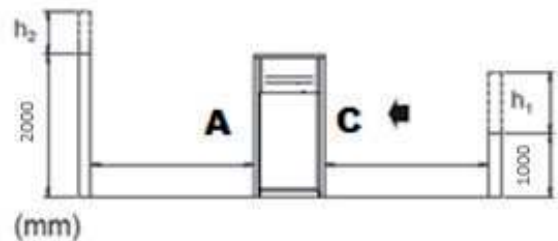

$$h_2 > 0 \rightarrow A \geq A + \frac{h_2}{2}$$

$$h_1 > 0 \rightarrow C \geq C + \frac{h_1}{2}$$

If two units are installed in a free field side by side along their longer sides, A and C, the minimum recommended distance between them is 1000 mm; if two units are installed side by side along their shorter sides, sides B and D, the minimum distance between them should be 500 mm. Should the unit be installed without observing the recommended minimum distances from walls and/or vertical obstacles, there could be a combination of warm air recirculation and/or insufficient supply to the aircooled condenser which could cause a reduction of capacity and efficiency.

In any case, the microprocessor will allow the unit to adapt itself to new operating conditions and deliver the maximum available capacity under any given circumstances, even if the lateral distance is lower than recommended, unless the operating conditions should affect personnel safety or unit reliability.

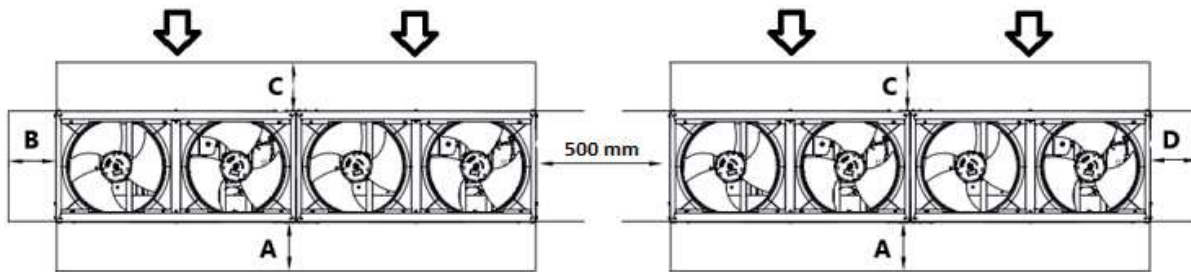
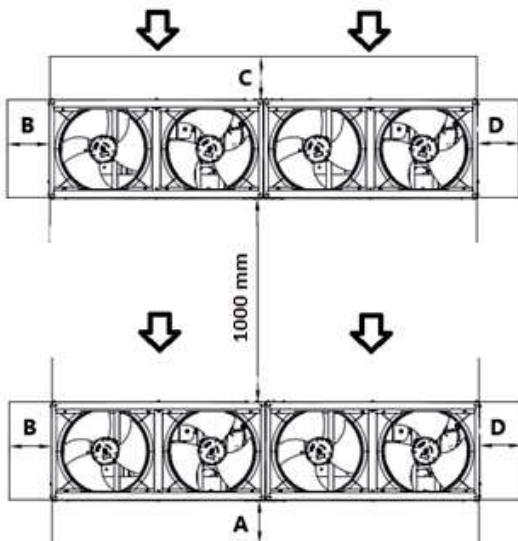

Figure 7 – Units installed side by side along their shorter sides, B or D

Case 1



Case 2

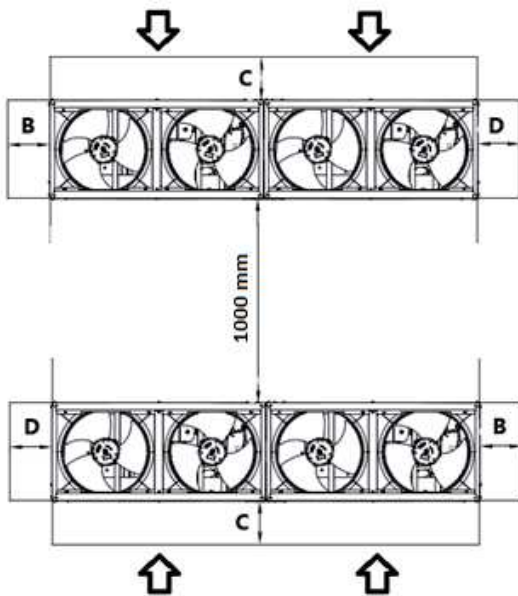

Figure 8 – Units installed side by side along their longer sides (Case 1 and Case 2)

The minimum distances, reported above, ensure functionality of the unit in most applications.

4.5. Additional installation site requirements

- When installing, take strong winds, typhoons or earthquakes into account, improper installation may result in the unit turning over.
- Take care that in the event of a water leak, water cannot cause any damage to the installation space and surroundings.
- Be sure that the air inlet of the unit is not positioned towards the main wind direction. Frontal wind will disturb the operation of the unit. If necessary, use a screen to block the wind.
- Ensure that water cannot cause any damage to the location by adding water drains to the foundation and prevent water traps in the construction.

Seaside installation. Make sure the outdoor unit is NOT directly exposed to sea winds. This is to prevent corrosion caused by high levels of salt in the air, which might shorten the life of the unit.

Install the outdoor unit away from direct sea winds.

Example: Behind the building (case I).

If the outdoor unit is exposed to direct sea winds, install a Windbreaker (case II).

- Height of windbreaker $\geq 1.5 \times$ height of outdoor unit
- Mind the service space requirements when installing the windbreaker.

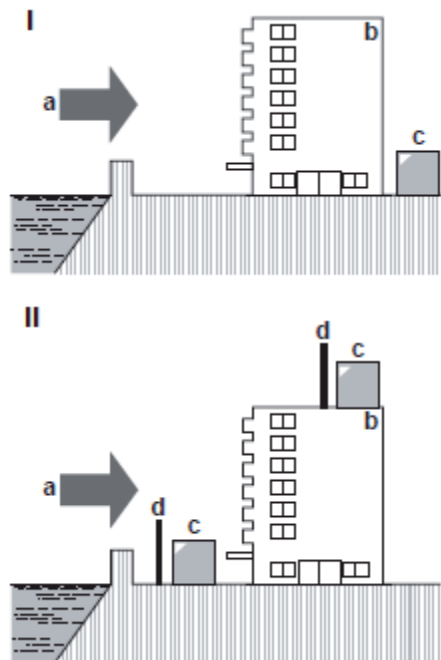

Figure 9 – Seaside installation of the outdoor unit

Legend:

- a. Sea wind
- b. Building
- c. Outdoor unit
- d. Windbreaker



When operating the unit in a low outdoor ambient temperature, be sure to follow the instructions described below.

To prevent exposure to wind and snow, install a baffle plate on the air side of the outdoor unit: In heavy snowfall areas it is very important to select an installation site where the snow will NOT affect the unit. If lateral snowfall is possible, make sure that the heat exchanger coil is NOT affected by the snow. If necessary, install a snow cover or shed and a pedestal.

For instructions on how to install the snow cover, contact your dealer.



When installing the snow cover, do NOT obstruct the air flow of the unit.

4.6. Noise and acoustic protection

The unit is a source of noise mainly due to rotation of compressors and fans. The noise level for each model size is listed in sales documentation. If the unit is correctly installed, operated and maintained the noise emission level do not require any special protection device to operate continuously close to the unit without any risk.

4.7. Water circuit for connection with the unit

4.7.1. Water piping

Piping must be designed with the lowest number of elbows and the lowest number of vertical changes of direction. In this way, installation costs are reduced considerably, and system performance is improved.

The water system must have:

1. Antivibration mountings to reduce transmission of vibrations to the structures.
2. Isolating valves to isolate the unit from the water system during maintenance.
3. To protect the unit, the BPHE must be protected against freezing by continuous monitoring of the water flow in the BPHE by a flow switch. In most cases, on site, the flow switch is set to generate an alarm only when the water pump turns off and the water flow drops to zero. It is recommended to adjust the flow switch to produce a "Water Leakage Alarm" when the water flow reaches the minimum value of the flow allowable (see table 1); in this case the BPHE is protected against freezing and the flow switch can detect the clogging of the water filter.
4. Manual or automatic air venting device at the system highest point and drain device at the system lowest point.
5. Neither the BPHE nor the heat recovery device must be positioned at the system's highest point.
6. A suitable device that can maintain the water system under pressure (expansion tank, etc.).
7. Water temperature and pressure indicators to assist the operator during service and maintenance.
8. A filter or device that can remove particles from the fluid. The use of a filter extends the life of the BPHE and pump and helps to keep the water system in a better condition. **The water filter must be installed as close as possible to the unit.** If the water filter is installed in another part of the water system, the Installer must guarantee the cleaning of the water pipes between the water filter and the BPHE. Precautions for correct use:
 - All water components and piping/hydraulic devices outside the unit must therefore be protected against freezing.
 - All water components (eg. BPHE) and piping/hydraulic devices must be emptied of water during the winter season, unless

an ethylene glycol mixture in appropriate percentage is added to the water circuit.

- In case of unit substitution, the entire water system must be emptied and cleaned before the new unit is installed. Regular tests and proper chemical treatment of water are recommended before starting up the new unit.
- If glycol is added to the water system as antifreeze protection, pay attention to the fact that suction pressure will be lower, the unit performance will be lower and water pressure drops will be greater. All unit protection systems, such as antifreeze, and low-pressure protection will have to be readjusted.
- When fastening the plant piping to the unit water piping, it is recommended to hold the threaded counterpart tight while fastening, to avoid unintentional rotations.

The maximum glycol percentage is 40% for all the unit.

In the following table are illustrated the minimum glycol percentage for low ambient air temperature

AMBIENT T [°C]	-3	-8	-15	-20
ETHYLENE GLYCOL	10%	20%	30%	40%
PROPYLENE GLYCOL	10%	20%	35%	40%

Table 2 – Minimum glycol percentage for low ambient air temperature

Protection of the water circuit is necessary in the winter season, even with the unit not in operation.

- Before insulating water piping, check that there are no leaks. The complete hydraulic circuit must be insulated to prevent condensation and reduced refrigeration capacity. Protect the water pipes from frost during winter (using for example a glycol solution or a heating cable).
 - Check that the water pressure does not exceed the design pressure of the water side heat exchangers. Install a safety valve on the water pipe downstream of the BPHE.
9. Select the piping diameter in relation to the required water flow and available external static pressure of the pump. See the following table for the recommended water piping diameter.

Unit	Water piping diameter
EWAT/EWYT016-040CZ(N/P/H)-A1	1 ¼"
EWAT/EWYT040-090CZ(N/P/H)-A2	2"

4.7.2. Flow switch

Flow switch is a standard component fitted to all units. To ensure sufficient water flow through the plate exchanger, it is essential that a flow switch be installed on the water circuit. It is already installed in the standard supply. The purpose of the flow switch is to stop the unit in the event of interrupted water flow, thus protecting the BPHE from freezing.

This is a palette flow switch appropriate for uninterrupted use outdoors (IP65).

The flow switch is set up to intervene when the water flow of the BPHE reaches the minimum value of the flow acceptable (see the table below).

Model	Flow switch Setpoint [l/min]
EWAT/EWYT016CZ(N/P/H)-A1	22
EWAT/EWYT021CZ(N/P/H)-A1	22
EWAT/EWYT025CZ(N/P/H)-A1	22
EWAT/EWYT032CZ(N/P/H)-A1	31
EWAT/EWYT040CZ(N/P/H)-A1	31
EWAT/EWYT040CZ(N/P/H)-A2	57
EWAT/EWYT050CZ(N/P/H)-A2	57
EWAT/EWYT064CZ(N/P/H)-A2	57
EWAT/EWYT090CZ(N/P/H)-A2	57

Table 3 – Flow Switch Setpoint

To ensure correct operation of the unit, the value of the water flow in the evaporator must be within the declared range for that unit. A water flow lower than the minimum value shown in the following table (table 4) could cause problems with freezing, fouling and poor control. A water flow rate higher than the maximum value shown in table 4 will result in an unacceptable load loss and excessive erosion of the pipes, with vibrations that can cause breakage

N – Naked Version		
MODEL	Min Flow [l/s]	Max flow [l/s]
EWAT/EWYT016CZN-A1	0.44	2.34
EWAT/EWYT021CZN-A1	0.84	2.66
EWAT/EWYT025CZN-A1	0.84	2.66
EWAT/EWYT032CZN-A1	1.01	2.66
EWAT/EWYT040CZN-A1	1.01	2.66
EWAT/EWYT040CZN-A2	1.41	6.00
EWAT/EWYT050CZN-A2	1.41	6.00
EWAT/EWYT064CZN-A2	1.41	6.00
EWAT/EWYT090CZN-A2	2.43	6.66

P – H Pump version		
MODEL	Min flow [l/s]	Max flow [l/s]
EWAT/EWYT016CZ(P/H)-A1	0.44	1.70
EWAT/EWYT021CZ(P/H)-A1	0.84	1.90
EWAT/EWYT025CZ(P/H)-A1	0.84	1.90
EWAT/EWYT032CZ(P/H)-A1	1.01	2.66
EWAT/EWYT040CZ(P/H)-A1	1.01	2.66
EWAT/EWYT040CZ(P/H)-A2	1.41	3.89
EWAT/EWYT050CZ(P/H)-A2	1.41	3.89
EWAT/EWYT064CZ(P/H)-A2	1.41	5.50
EWAT/EWYT090CZ(P/H)-A2	2.43	6.00

Table 4 – Operating limits

4.7.3. Heat recovery (optional)

Units may be optionally equipped with heat recovery system.

This system is made by a water cooled heat exchanger located on the compressors discharge pipe.

To guarantee compressor operation within its envelope, units with heat recovery cannot operate with water temperature of the heat recovery water lower than 20°C.

It is a responsibility of plant designer and chiller installer to guarantee the respect of this value (e.g. using recirculating bypass valve).

4.7.4. Preparing and checking the water circuit connection

The units have water inputs and outputs for connecting the heat pump to water circuit of the system. This circuit must be connected to the unit by an authorized technician and must comply with all regulations on the subject.



If dirt penetrates the water circuit, there could be problems.

Therefore, always remember the following when connecting the water circuit:

- Only use pipes that are clean inside.
- Keep the end of the pipe facing downward when removing any burrs.
- Cover the end of the pipe when inserting it through a wall to avoid dust and dirt getting in.
- Clean the pipes of the system located between the filter and the unit, with running water, before connecting it to the system.

4.7.5. Water pressure

Check whether the water pressure is above 1 bar. If it is lower, add water.

The maximum operating pressure is 3 bar for P and H versions.

For N version please take care that the components installed in the field piping can withstand the water pressure “maximum 3 bar + static pressure of the external pump” and not exceeding 10 bar.

4.7.6. Hydraulic diagram

The unit is supplied with the following hydraulic components:

WATER CIRCUIT

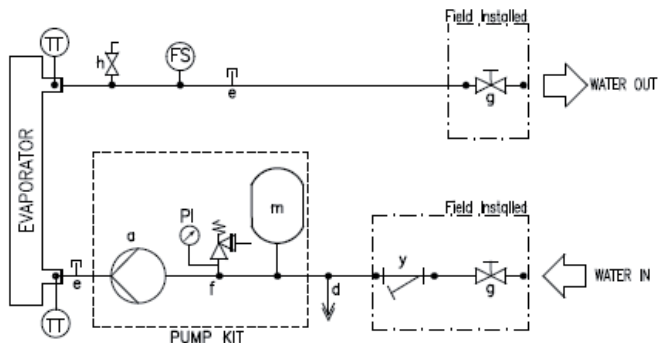

Figure 10 – Hydraulic diagram

N.B. The Pump kit is optional

WATER CIRCUIT EQUIPMENT

- | | | | |
|---|----------------------|----|--------------------|
| a | PUMP | m | EXPANSION VESSEL |
| d | DRAIN | y | WATER FILTER |
| e | PLUGGED FITTING | TT | TEMPERATURE SENSOR |
| f | SAFETY VALVE 3BAR ½" | PI | PRESSURE GAUGE |
| g | SHUT OFF VALVE | FS | FLOWSWITCH |
| h | AIR VENT | | |

If air, moisture or dust gets into the circuit problems may occur. To prevent this use shut-off valves, and water filter which are delivered with the unit.

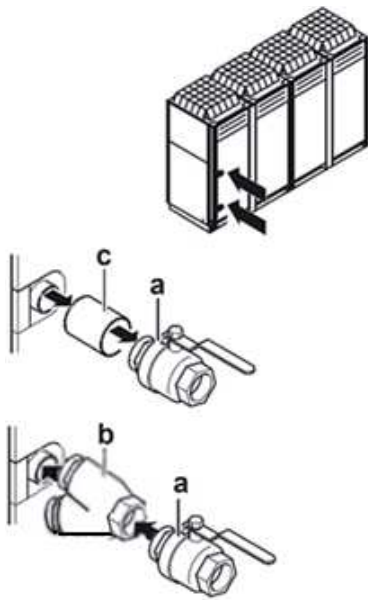

Legend:

- a. Shut-off valve
- b. Water filter
- c. Threaded connector

N.B. The hydraulic elements are supplied together with the unit and are located inside the cabinet.

4.8. Water treatment

Before putting the unit into operation, clean the water circuit.

The BPHE must not be exposed to flushing velocities or debris released during flushing. It is recommended that a suitably sized bypass and valve arrangement is installed to allow flushing of the piping system. The bypass can be used during maintenance to isolate the heat exchanger without disrupting flow to other units.

Any damage due to the presence of foreign bodies or debris in the BPHE will not be covered by warranty. Dirt, scales, corrosion debris and other material can accumulate inside the heat exchanger and reduce its heat exchanging capacity. Pressure drop can increase as well, thus reducing water flow. Proper water treatment therefore reduces the risk of corrosion, erosion, scaling, etc. The most appropriate water treatment must be determined locally, according to the type of system and water characteristics.

The manufacturer is not responsible for damage to or malfunctioning of equipment caused by failure to treat water or by improperly treated water. In the following table are listed the acceptable water quality limits:

DAE Water quality requirements	BPHE
Ph (25 °C)	7.5 – 9.0
Electrical conductivity [$\mu\text{S}/\text{cm}$] (25°C)	< 500
Chloride ion [mg Cl / l]	< 70 (HP ¹); < 300 (CO ²)
Sulphate ion [mg SO ₄ ²⁻ / l]	< 100
Alkalinity [mg CaCO ₃ / l]	< 200
Total Hardness [mg CaCO ₃ / l]	75 ÷ 150
Iron [mg Fe / l]	< 0.2
Ammonium ion [mg NH ₄ ⁺ / l]	< 0.5
Silica [mg SiO ₂ / l]	
Chlorine molecular (mg Cl ₂ /l)	< 0.5

Note: 1. Heat Pump
2. Cooling Only

Table 5 – Acceptable water quality limits

4.9. Water pressure drops for filters

In the following figure the water filter pressure drops are illustrated.

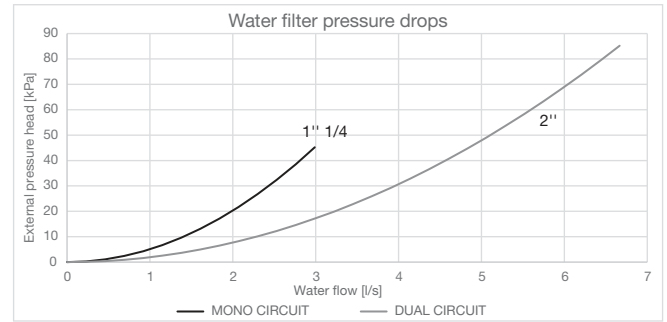

Figure 11 – Water filter pressure drops

4.10. Pump kit mounted on board (Optional)

Before to starting up the pump, ensure that the hydraulic circuit is filled correctly with a minimum static pressure of 1 bar as protection from cavitation. Furthermore, to ensure correct venting of the piping system make sure the venting valve indicated on the hydraulic diagrams with the letter “h”, is open.

In the following figure are illustrated the External pressure head (KPa) in case of Low lift and High lift pump.

EWA(Y)T-CZP – Pump Low lift

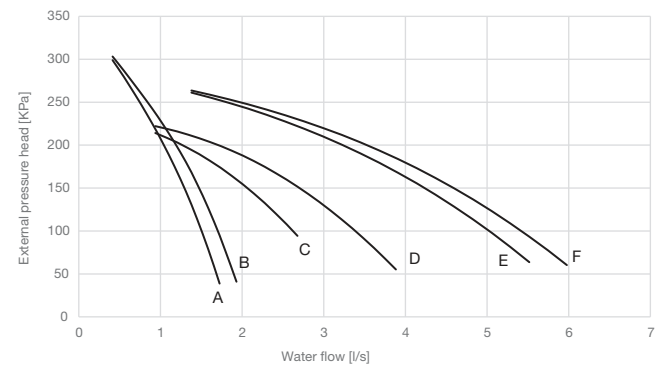

Figure 12 – External pressure head of Low Lift Pump

EWA(Y)T-CZH – Pump High lift

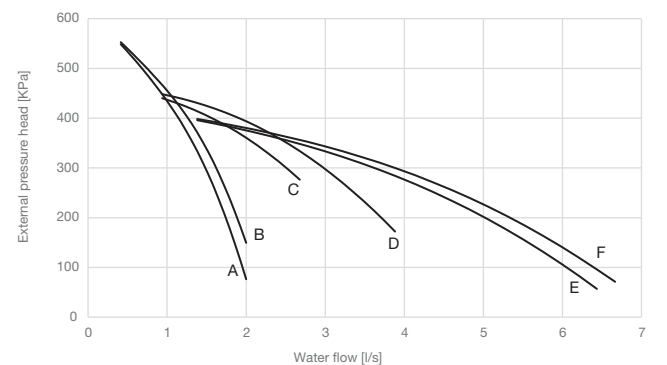

Figure 13 – External pressure head of High Lift Pump

External static pressure refers to unit equipped with hydronic kit, defined as difference between pump external static pressure and evaporator and water filter pressure drop. Water flow range refer to pump only. For water flow limits of the unit refer to water flow section.

Pump Low lift	
Model	Pump curve
EWAT/EWYT016CZP-A1	A
EWAT/EWYT021CZP-A1	B
EWAT/EWYT025CZP-A1	B
EWAT/EWYT032CZP-A1	C
EWAT/EWYT040CZP-A1	C
EWAT/EWYT040CZP-A2	D
EWAT/EWYT050CZP-A2	D
EWAT/EWYT064CZP-A2	E
EWAT/EWYT090CZP-A2	F

Pump High lift	
Model	Pump curve
EWAT/EWYT016CZHA1	A
EWAT/EWYT021CZHA1	B
EWAT/EWYT025CZHA1	B
EWAT/EWYT032CZHA1	C
EWAT/EWYT040CZHA1	C
EWAT/EWYT040CZHA2	D
EWAT/EWYT050CZHA2	D
EWAT/EWYT064CZHA2	E
EWAT/EWYT090CZHA2	F

Table 6 – Pump curve associated with each unit size

4.11. Operation limits

Operation out of the mentioned limits may damage the unit. In case of any doubt contact the manufacturer representative. In the following figure are illustrated the operation ranges both in cooling and heating mode, in terms of Leaving water temperature (LWT) and Ambient temperature (OAT).

OPERATION RANGE COOLING – EWAT-CZ

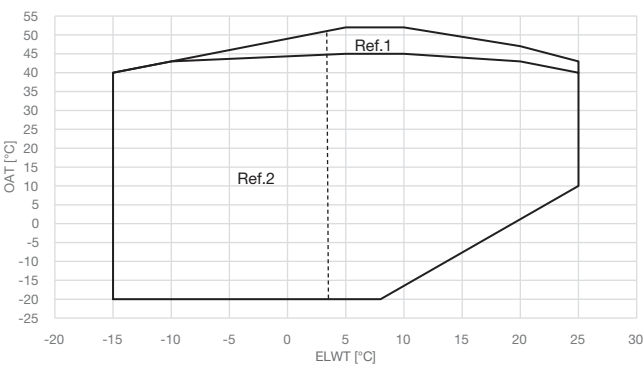

Figure 14 – Operating limits on EWATCZ

OAT	Outside ambient temperature
ELWT	Evaporator Leaving water temperature
Ref. 1	Unit operations in this area require OP. 192 HIGH AMBIENT TEMPERATURE KIT.
Ref. 2	Unit operations in this area require the enabling of the Brine version in the controller and the use of the proper amount of glycol.

OPERATION RANGE COOLING – EWYT-CZ

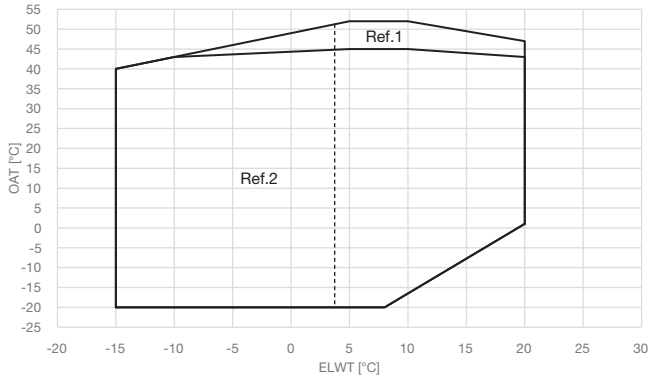

Figure 15 – Operating limits on EWYT-CZ in cooling mode

OPERATION RANGE HEATING – EWYT-CZ EWYT021~090-CZ

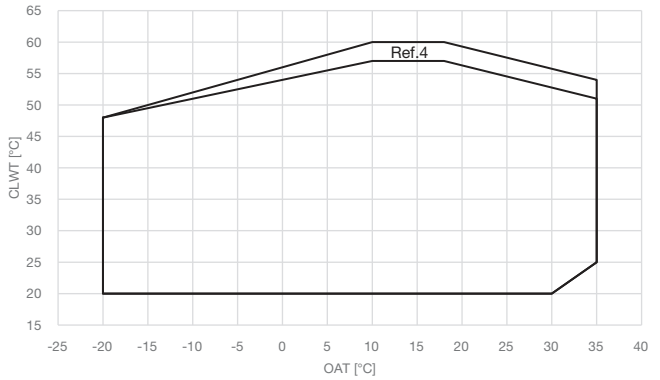
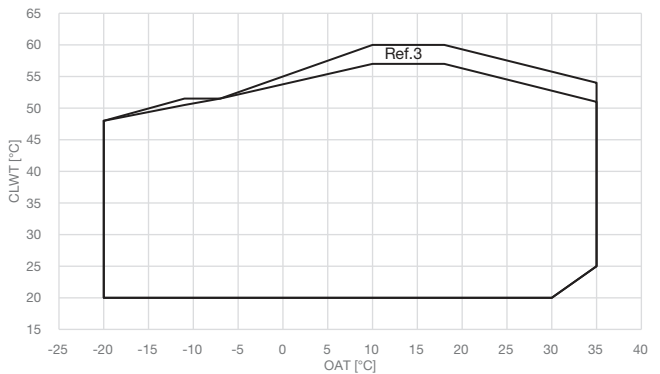

Figure 16 – Operating limits on EWYT-CZ in heating mode

OAT	Outside ambient temperature
CLWT	Condenser Leaving water temperature
Ref. 1	Unit operations in this area require OP. 192 HIGH AMBIENT TEMPERATURE KIT.
Ref. 2	Unit operations in this area require the enabling of the Brine version in the controller and the use of the proper amount of glycol.
Ref. 3	Certain unit sizes might work in part load in this area.
Ref. 4	Certain unit sizes might work in part load in this area. Selecting the accessory EKDAGBL "Restricted Application Definer" the unit can't work in this specific area.

EWYT016-CZ



The charts shown above constitute a guideline on operating limits in the range.

Refer to the **CSS selection software** for the actual operating limits in the working conditions for each model.

4.12. Operating stability and minimum water content in the system

For the correct functioning of the machines it is important to guarantee a minimum water content inside the system, avoiding an excessive number of compressor startups and stops. In fact, every time the compressor starts working, an excessive amount of oil from the compressor enters the circulation in the refrigerant circuit and at the same time there is an increase in the temperature of the compressor stator, generated by the inrush current of the starting. In order to prevent damage to the compressor, the control system will therefore permit no more than 10 startups per hour. The plant where the unit is installed must therefore ensure that the overall water content allows constant operation of the unit and consequently also greater environmental comfort.

As a general indication the water content should not be less than the values in the following table:

HeatPump	Suggested L/kW	Min water content [L]
EWYT016CZ(N/P/H)-A1	5.7	90
EWYT021CZ(N/P/H)-A1	5.0	100
EWYT025CZ(N/P/H)-A1	4.4	110
EWYT032CZ(N/P/H)-A1	4.9	160
EWYT040CZ(N/P/H)-A1	4.6	180
EWYT040CZ(N/P/H)-A2	3.0	120
EWYT050CZ(N/P/H)-A2	2.6	130
EWYT064CZ(N/P/H)-A2	2.7	170
EWYT090CZ(N/P/H)-A2	2.7	230

CoolingOnly	Suggested L/kW	Min water content [L]
EWAT016CZ(N/P/H)-A1	3.7	58
EWAT021CZ(N/P/H)-A1	2.8	58
EWAT025CZ(N/P/H)-A1	2.3	58
EWAT032CZ(N/P/H)-A1	2.8	90
EWAT040CZ(N/P/H)-A1	2.3	90
EWAT040CZ(N/P/H)-A2	1.5	60
EWAT050CZ(N/P/H)-A2	1.2	60
EWAT064CZ(N/P/H)-A2	1.1	73
EWAT090CZ(N/P/H)-A2	1.0	90

Table 7 – Minimum water content in the system



Extra water may be required in critical processes or in spaces with a high thermal load.

The difference in startup temperature may vary from 1 to 5 K. This has an impact on the minimum water volume required when the unit is functioning in cooling mode. The unit is preset for a startup temperature difference of 2.5 K.

The Thermo ON condition is shown below:

$$EWT > \text{Setpoint} + \text{startup } \Delta T$$

	Default	Max	Min
startup ΔT (K)	2.5	5	1

By default, the unit is set to have a water temperature difference of 2.5 K which allows it to operate with the minimum volume mentioned in the previous table. However, if a smaller temperature differential is set, as in the case of process cooling applications where temperature fluctuations must be avoided, a larger minimum water volume will be required.

To ensure proper operation of the unit when changing the value of setting, the minimum water volume has to be corrected. If this volume exceeds the range allowed in the unit, an additional expansion vessel or a buffer tank must be installed in the field piping.

Minimum water volume correction factor

A water volume correction factor “a” is introduced on the basis of the difference in startup temperature “b”, the function of which is:

$$a \cdot b = 2.5$$

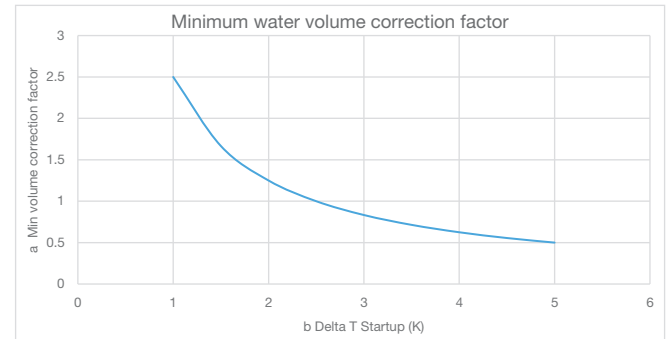

Figure 17 – Minimum water volume correction factor

Example:

To illustrate the impact on the system when modifying the setting, we will consider a unit with a minimum allowable water volume of 58 L. Assuming that the setting is changed from Delta T 2.5 K (default) to 1.5 K. The correction factor to be applied is $a = \frac{2.5}{1.5} = 1.67$, and so to calculate the minimum water content in the system for a 25 kW unit, in cooling mode, all we need to do is multiple the default minimum volume by this correction factor to obtain the new minimum volume, 97L.

4.13. Calibrating the expansion vessel

The expansion vessel's starting pressure depends on the difference between the level at which the unit is installed and the highest point in the water circuit, and is calculated as follows:

$$P_i = 0.3 + (H/10) \text{ (bar)}$$

- P_i Initial pressure
- H Difference between the level at which the unit is installed and the highest point in the circuit

A unit with an onboard pump has a 12 liters expansion vessel with an initial pressure of 1 bar.

Maximum water volume

Refer to the graph below to determine the maximum water volume in order to calibrate the expansion vessel:

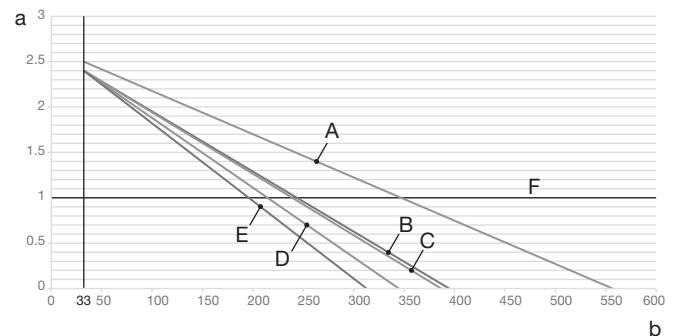

Figure 18 – Initial expansion vessel pressure on the basis of maximum water volume

- a Initial pressure of the expansion vessel [bar]
- b Maximum water volume [L]
- A Circuit without glycol
- B Circuit with 30% ethylene glycol
- C Circuit with 40% ethylene glycol
- D Circuit with 30% propylene glycol
- E Circuit with 40% propylene glycol
- F Default

The default value for initial pressure, shown in the figure, refers to a difference in H of 7 metres.

If the total water volume in the entire circuit exceeds the permitted maximum volume, another expansion vessel must be installed. If the difference in system H is less than 7 metres and the initial pressure reading is lower than the maximum permitted value (refer to the graph), no adjustment of initial pressure is required.

If it is necessary to change the default initial pressure value (1 bar), take the following recommendations into consideration:

- Use dry nitrogen only to set the initial pressure in the expansion vessel.
- An inappropriate initial pressure setting in the expansion vessel will result in malfunctioning of the system.

Changes to the initial pressure of the expansion vessel must be made by reducing or increasing nitrogen pressure using the Schrader valve on the expansion vessel.

NOTICE

Only an authorised installer can adjust the initial pressure of the expansion vessel.

To check water volume: examples

Example 1

The unit is installed 5 m below the highest point in the water circuit. The total water volume in the water circuit is 250 litres. No actions or changes required.

Example 2

The unit is installed at the highest point in the water circuit. The total water volume in the water circuit (without the glycol) is 420 l.

Actions:

As the total water volume (420 l) is higher than the preset water volume (340 l), prepressure must be reduced.

The required prepressure is:

$$P_g = (0.3 + (H / 10)) \text{ bar} = (0.3 + (0/10)) \text{ bar} = 0.3 \text{ bar}$$

The corresponding maximum water volume is about 490 l (see graph).

As 420 l is less than 490 l, the expansion vessel is appropriate for the installation.

4.14. Antifreeze protection for BPHE and recovery exchangers

If the heat exchangers are completely empty and cleaned with antifreeze solution, additional methods can be used against freezing.

The following protection methods must be considered when designing the system as a whole:

1. continuous water flow circulation inside piping and exchangers;
2. addition of an appropriate amount of glycol inside the water circuit or, as alternative, an additional heat insulation and heating of exposed piping (internal and external to the unit);
3. if the unit does not work during the winter season, emptying and cleaning of the heat exchanger.

It is the responsibility of the installer and/or of local maintenance personnel to ensure that described antifreeze methods are used. Make sure that appropriate antifreeze protection is always

maintained. Failing to follow the instructions above could result in unit damage.

4. ELECTRIC HEATER (Option on request). A heater tape is installed on the water side components (the plates heat exchanger and the expansion vessel) to protect vital parts of the hydraulic system inside the unit. This heater tape will only protect internal parts of the unit. It cannot protect field installed parts outside the unit. Field heater tapes must be provided by the installer. ⁽¹⁾



Damage caused by freezing is excluded from the warranty, therefore Daikin Applied Europe S.p.A. declines all responsibility.

(1) Heat recovery exchanger is not equipped with heater tape.

5. ELECTRICAL INSTALLATION

5.1. General specifications

Refer to the specific wiring diagram for the unit you have bought. Should the wiring diagram not be on the unit or should it have been lost, please contact your manufacturer representative, who will send you a copy.

In case of discrepancy between wiring diagram and electrical panel/cables, please contact the manufacturer representative.



All electrical connections to the unit must be carried out in compliance with laws and regulations in force.

All installation, management and maintenance activities must be carried out by qualified personnel.

There is a risk of electric shock and burning.

Electrical equipment is capable of operating correctly in the intended ambient air temperature. For very hot/cold environments (refer to 4.11, "Operation limits"), additional measures are recommended (contact the manufacturer representative).

The electrical equipment is capable of operating correctly when the relative humidity does not exceed 50% at a maximum temperature of +40 °C. Higher relative humidities are permitted at lower temperatures (for example 90% at 20 °C).

5.2. Electric connections

Provide an electrical circuit to connect the unit. It must be connected to the copper cables with an adequate section relative to the absorption values and according to the current electrical standards.

Daikin Applied Europe S.p.A. declines all responsibility for an inadequate electrical connection.



The connections to the terminals must be made with copper terminals and cables, otherwise overheating or corrosion may occur at the connection points with the risk of damaging the unit. The electrical connection must be carried out by qualified personnel, in compliance with the laws in force. There is a risk of electric shock.

The power supply to the unit must be set up in such a way that it can be switched on or off independently from that of other system components and other equipment in general, by means of a general switch.

The electrical connection of the panel must be carried out maintaining the correct sequence of the phases. Refer to the specific wiring diagram for the unit you have bought. In case of discrepancy between the wiring diagram and electrical panel/cables, please contact the manufacturer representative.



Do not apply torque, tension or weight to the main switch terminals. Power line cables must be supported by appropriate systems.

To avoid interference, all control wires must be connected separately from the power cables. To do this, use several electrical passage ducts.

The protections for the power supply system must be designed according to the values mentioned above. A fuse must be present on each phase and, where provided for by the national laws of the country of installation, a leak detector to earth.



Before any electrical connection work to the compressor motor and / or the fans, make sure that the system is switched off and the main switch of the unit is open. Failure to observe this rule could result in serious personal injury.

5.3. Cable requirements

The cables connected to the circuit breaker must respect the insulation distance in the air and the surface isolation distance between the active conductors and the earth, according to IEC 614391 table 1 and 2, and to the local national laws.

The cables connected to the main switch must be tightened using a pair of keys and respecting the unified clamping values, relative to the quality of the screws of the washers and nuts used.

Connect the earth conductor (yellow / green) to the PE ground terminal.

The equipotential protection conductor (earth conductor) must have a section according to table 1 of EN 602041 Point 5.2, shown below.

In any case, the equipotential protection conductor (earth conductor) must have a cross section of at least 10 mm², in accordance with point 8.2.8 of the same standard.

Section of the copper phase conductors feeding the equipment S [mm ²]	Minimum cross section of the external copper protection conductor Sp [mm ²]
S ≤ 16	S
16 < S ≤ 35	16
S > 35	S/2

Table 8 – Table 1 of EN602041 Point 5.2

5.3.1. Maximum cable dimension

Maximum cable dimension that can be physically connected to main switch of the unit.

Model	Max cable size [mm ²]	Model [A]	Max cable size [mm ²]	Model [A]
	STD Configuration		High Ambient Temperature Kit OP.192	
EWAT/EWYT016CZ(N/P/H)-A1	16	63	16	63
EWAT/EWYT021CZ(N/P/H)-A1	16	63	16	63
EWAT/EWYT025CZ(N/P/H)-A1	16	63	16	63
EWAT/EWYT032CZ(N/P/H)-A1	16	63	50	100
EWAT/EWYT040CZ(N/P/H)-A1	16	63	50	100
EWAT/EWYT040CZ(N/P/H)-A2	50	80	50	80
EWAT/EWYT050CZ(N/P/H)-A2	50	80	50	80
EWAT/EWYT064CZ(N/P/H)-A2	50	100	70	125
EWAT/EWYT090CZ(N/P/H)-A2	70	125	70	125

5.3.2. Safety device requirements

The power supply must be protected with a Residual current device, as indicated in the table below.

Main switch and Fuses can be added in accordance with the applicable legislation.

Selection and sizing of the wiring should be done in accordance with the applicable legislation based and the maximum unit current.

Model	Customer Protection - Mandatory	Fuses - Not Mandatory
EWAT/EWYT016CZ(N/P/H)-A1	Residual Current device Type A	32A
EWAT/EWYT021CZ(N/P/H)-A1		40A
EWAT/EWYT025CZ(N/P/H)-A1		40A
EWAT/EWYT032CZ(N/P/H)-A1		63A
EWAT/EWYT040CZ(N/P/H)-A1		63A
EWAT/EWYT040CZ(N/P/H)-A2		80A
EWAT/EWYT050CZ(N/P/H)-A2		80A
EWAT/EWYT064CZ(N/P/H)-A2		100A
EWAT/EWYT090CZ(N/P/H)-A2		125A
		50A
		63A
		80A
		80A
		100A
		160A



When using residual current operated circuit breakers, be sure to use a high speed type 300 mA rated residual operating current.

5.4. Phase unbalance

In a three-phase system, the excessive unbalance between the phases is the cause of the engine overheating. The maximum permitted voltage unbalance is 3%, calculated as follows:

$$\text{Imbalance \%} = \frac{(V_x - V_m) * 100}{V_m}$$

where:

V_x = phase with greatest imbalance

V_m = average of the voltages

Example:

the three phases measure 383, 386 and 392 V respectively.

The average is:

$$\frac{383 + 386 + 392}{3} = 387 \text{ V}$$

The unbalance percentage is:

$$\frac{(392 - 387) * 100}{387} = 1.29 \%$$

less than the maximum allowed (3%).

6. OPERATOR'S RESPONSIBILITIES

It is essential that the operator is appropriately trained and becomes familiar with the system before operating the unit. In addition to reading this manual, the operator must study the microprocessor operating manual and the wiring diagram to understand startup sequence, operation, shutdown sequence and operation of all the safety devices.

During the unit initial startup phase, a technician authorized by the manufacturer is available to answer any questions and to give instructions as to the correct operating procedures.

The operator must keep a record of operating data for every installed unit. Another registration must also be kept for all the periodic maintenance and assistance activities.

If the operator notes abnormal or unusual operating conditions, he is advised to consult the technical service authorized by the manufacturer.



If the unit is switched off, the compressor oil heater cannot be used. Once the unit is reconnected to the mains, leave the compressor oil heater charged for at least 6 hours before restarting the unit.

Failure to observe this rule may cause damage to the compressors due to excessive accumulation of liquid inside them.

This unit represents a substantial investment and deserves the attention and care to keep this equipment in good working order.

However, during operation and maintenance it is essential to observe the following instructions:

- Do not allow unauthorized and / or unqualified personnel to access the unit;
- It is forbidden to access the electrical components without having opened the unit main switch and switched off the power supply;
- It is forbidden to access the electrical components without using an insulating platform. Do not access the electrical components if water and/or moisture are present;
- Verify that all operations on the refrigerant circuit and on the components under pressure are carried out exclusively by qualified personnel;
- The replacement of the compressors must be carried out exclusively by qualified personnel;
- Sharp edges and the surface of the condenser section could cause injury. Avoid direct contact and use adequate protection device;
- Do not introduce solid objects into the water pipes while the unit is connected to the system;
- It is absolutely forbidden to remove all protections of moving parts.

In case of sudden stop of the unit, follow the instructions on the Control Panel Operating Manual which is part of the on board documentation delivered to the end user.

It is strongly recommended to perform installation and maintenance with other people.



Avoid installing the unit in areas that could be dangerous during maintenance operations, such as platforms without parapets or railings or areas not complying with the clearance requirements around the unit.

7. MAINTENANCE

Personnel working on the electrical or the refrigeration components must be authorized, trained and fully qualified.

Maintenance and repair requiring the assistance of other skilled personnel should be carried out under the supervision of the person competent in the use of flammable refrigerants. Any person conducting servicing or maintenance on a system or associated parts of the equipment should be competent according to EN 13313.

Persons working on refrigerating systems with flammable refrigerants should have competence in safety aspects of flammable refrigerant handling supported by evidence of appropriate training.

No person carrying out work in relation to a refrigerating system which involves exposing any pipe work shall use any sources of ignition in such a manner that it may lead to the risk of fire or explosion. All possible ignition sources, including cigarette smoking, should be kept sufficiently far away from the site of installation, repairing, removing and disposal, during which refrigerant can possibly be released to the surrounding space. Prior to work taking place, the area around the equipment is to be surveyed to make sure that there are no flammable hazards or ignition risks. "No Smoking" signs shall be displayed.

Always protect the operating personnel with personal protective equipment appropriate for the tasks to be performed. Common individual devices are: Helmet, goggles, gloves, caps, safety shoes. Additional individual and group protective equipment should be adopted after an adequate analysis of the specific risks in the area of relevance, according to the activities to be performed.

electrical components	Never work on electrical components until the machine's main power supply has been cut off with the main switch on the electrical panel. Wait 10 minutes after cutting off the machine's power supply before opening the electrical panel, to prevent the risk of high voltage due to firing of the capacitors.
refrigerating system	<p>The following precautions should be taken before working on the refrigerant circuit:</p> <ul style="list-style-type: none"> • obtain permit for hot work (if required); • ensure that no flammable materials are stored in the work area and that no ignition sources are present anywhere in the work area; • ensure that suitable fire extinguishing equipment is available; • ensure that the work area is properly ventilated before working on the refrigerant circuit or before welding, brazing or soldering work; • ensure that the leak detection equipment being used is nonsparking, adequately sealed or intrinsically safe; • ensure that all maintenance staff have been instructed. • Always perform the following procedure before working on the refrigerant circuit: <ul style="list-style-type: none"> • remove refrigerant (specifying residual pressure); • purge circuit with inert gas (e.g. nitrogen); • evacuate at a pressure of 0.3 bar (ass.) (or 0.03 MPa); • purge circuit with inert gas (e.g. nitrogen) again; • open the circuit. <p>If compressors or compressor oils are to be removed, it should be ensured that it has been evacuated to an acceptable level to ensure that there is no flammable refrigerant remaining within the lubricant. Only refrigerant recovery equipment designed for use with flammable refrigerants should be employed.</p>

If the national rules or regulations permit the refrigerant to be drained, this should be done safely, using a hose, for example, through which the refrigerant is discharged into the outside atmosphere in a safe area. It should be ensured that an inflammable explosive refrigerant concentration cannot occur near an ignition source or penetrate into a building under any circumstance.

In the case of refrigerating systems with an indirect system, the heat transfer fluid should be checked for the possible presence of refrigerant.

After any repair work, the safety devices, for example refrigerant detectors and mechanical ventilation systems, should be checked and the results recorded.

It should be ensured that any missing or illegible label on components of the refrigerant circuit is replaced.

Sources of ignition should not be used when searching for a refrigerant leak.

7.1. Pressure / temperature table

°C	Bar	°C	Bar	°C	Bar	°C	Bar
28	2.97	2	7.62	24	16.45	50	31.41
26	3.22	0	8.13	26	17.35	52	32.89
24	3.48	2	8.67	28	18.30	54	34.42
22	3.76	4	9.23	30	19.28	56	36.00
20	4.06	6	9.81	32	20.29	58	37.64
18	4.37	8	10.43	34	21.35	60	39.33
16	4.71	10	11.07	36	22.45	62	41.09
14	5.06	12	11.74	38	23.60	64	42.91
12	5.43	14	12.45	40	24.78	66	44.79
10	5.83	16	13.18	42	26.01	68	46.75
8	6.24	18	13.95	44	27.29	70	48.77
6	6.68	20	14.75	46	28.61	72	50.87
4	7.14	22	15.58	48	29.99	74	53.05

Table 9 – R32 Pressure/Temperature

7.2. Routine maintenance

This unit must be maintained by qualified technicians. Before beginning any work on the system, the personnel shall assure that all security precautions have been taken.

Neglecting unit maintenance could degrade all parts of the units (coils, compressors, frames, pipes, etc.) with negative effect on performances and functionality.

There are two different levels of maintenance, which can be chosen according to the type of application (critical/noncritical) or to the installation environment (highly aggressive).

Examples of critical applications are process cooling, data centres, etc.

Highly Aggressive Environments can be defined as the follows:

- Industrial environment (with possible concentration of fumes result of combustion and chemical process);
- Coastal environment;
- Highly polluted urban environment;
- Rural environment close to of animal excrement and fertilizers, and high concentration of exhaust gas from diesel generators;
- Desert areas with risk of sandstorms;
- Combinations of the above.

Table 10 lists all Maintenance activities for standard applications and standard environment.

Table 11 lists all Maintenance activities for critical applications or highly aggressive environment.

Unit exposed to a highly aggressive environment can face corrosion in a shorter time than ones installed on a standard environment. Corrosion causes a rapid rusting of the frame core, consequently decreases unit structure life time. To avoid that, it is necessary to wash periodically the frame surfaces with water and suitable detergents.

In case of part of unit frame paint came off, it is important to stop its progressive deterioration by repainting the exposed parts using proper products. Please contact factory to get the required products specifications.

In case of just salt deposits are present, it is enough to rinse the parts with fresh water.

7.2.1. Air Heat Exchanger Maintenance

Routine cleaning of air heat exchanger surfaces is essential to maintain proper operation of the unit, avoid corrosion and rusting. Elimination of contamination and removal of harmful residues will greatly increase the life of the coil and extend the life of the unit.

Remove surface dirt, leaves, fibers, etc. with a vacuum cleaner (preferably with a brush or other soft attachment rather than a metal tube), compressed air blown from the inside out, and/or a soft bristle (not wire!) brush. Do not impact or scrape the coil with the vacuum tube, air nozzle, etc.

Use of a water stream, such as a garden hose, against a surface loaded coil will drive the fibers and dirt into the coil. This will make cleaning efforts more difficult. Surface loaded fibers must be completely removed prior to using low velocity clean water rinse.

NOTE



A monthly clean water rinse is recommended for coils that are applied in coastal or industrial environments to help to remove chlorides, dirt and debris. It is very important when rinsing that the water temperature is below 55 °C.

Galvanic corrosion of the connection Copper/Aluminum can occur in corrosive atmosphere under the plastic protection; during the maintenance operations or periodic cleaning, check the aspect of the plastic protection of the copper/aluminum connection. If it is inflated, damaged or took off contact the manufacturer representative for advice and information.

7.2.2. Electrical Installation



All electrical maintenance activities must be followed by qualified personnel. Make sure the system is switched off and the main switch of the unit open. Failure to observe this rule could result in serious personal injury. When the unit is turned off but the disconnection switch is in the closed position, the unused circuits will still be active.

The maintenance of the electrical system consists of the application of some general rules as follows:

1. the current absorbed by the compressor must be compared to the rated value. Normally the value of the absorbed current is lower than the rated value that corresponds to the absorption of the full load compressor at the maximum operating conditions;
2. at least once every three months all the security checks must be made to verify their functionality. Each appliance, with aging, can change its point of operation and this must be monitored to adjust it or replace it. The pump interlocks and flow switches must be checked to make sure that they interrupt the control circuit if they intervene.

7.2.3. Service and limited warranty

All units are factory tested and guaranteed for 12 months as of the first startup or 18 months as of delivery.

These units have been developed and constructed according to high quality standards ensuring years of failure-free operation. **However, the unit requires maintenance even during the warranty period, from the time of installation and not just from the commissioning date.** We strongly advise stipulating a maintenance contract with a service authorized by the manufacturer to ensure efficient and problem-free service, thanks to the expertise and experience of our personnel.

It must be borne in mind that operating the unit in an inappropriate manner, beyond its operating limits or not performing proper maintenance according to this manual can void the warranty.

Observe the following points, to conform to warranty limits:

1. The unit cannot function beyond the specified limits;
2. The electrical power supply must be within the voltage limits and without voltage harmonics or sudden changes;
3. The three-phase power supply must not have an unbalance between phases exceeding 3%. The unit must stay turned off until the electrical problem has been solved;
4. No safety device, either mechanical, electrical or electronic must be disabled or overridden;
5. The water used for filling the water circuit must be clean and suitably treated. A mechanical filter must be installed at the point closest to the BPHE inlet;
6. The value of the BPHE water flow must be included in the declared range for the unit considered, refer to the CSS selection software.

List of Activities	Weekly	Monthly (Note 1)	Yearly/Seasonal (Note 2)
General:			
Reading of operating data (Note 3)	X		
Visual inspection of unit for any damage and/or loosening		X	
Verification of thermal insulation integrity		X	
Cleaning		X	
Paint where necessary			X
Analysis of water (4)			X
Check of flow switch operation		X	
Electrical Installation:			
Verification of control sequence			X
Verify contactor wear – Replace if necessary			X
Verify that all electrical terminals are tight – Tighten if necessary		X (Quarterly)	
Clean inside the electrical control board			X
Visual inspection of components for any signs of overheating		X	
Verify operation of compressor and electrical resistance		X	
Refrigeration circuit:			
Check for any refrigerant leakage (leak test)		X	
Analyze compressor vibrations			X
Hydraulic circuit:			
Check for any water leakage		X	
Check hydraulic connections		X	
Check the pressure at the pump inlet		X	
Clean the water filter			X
Check the glycol concentration			X
Check the water flow rate		X	
Check the safety valve			X
Coil section:			
Check the cleaning of coils and water heat exchangers (Note 5)			X
Verify that fans are well tightened			X
Verify the coil fins			X
BPHE:			
Check the cleaning of the BPHE			X

Table 10 – Standard Routine Maintenance Plan

Notes:

1. Monthly activities include all the weekly ones.
2. The annual (or early season) activities include all weekly and monthly activities.
3. Daily reading of the operating values of the unit allows maintaining high observational standards.
4. Check for any dissolved metals.
5. Clean condenser banks with clean water and water heat exchangers with appropriate chemicals. Particles and fibers could clog up the exchangers, especially for water exchangers pay attention if water rich in calcium carbonate is used. An increase in pressure drops or a decrease in thermal efficiency means that the heat exchangers are clogged. In environments with a high concentration of airborne particles, it might be necessary to clean the condenser bank more often.
6. Units placed or stored in a Highly Aggressive Environment for long time without operation are still subject to those routine maintenance steps.

List of Activities (Note 8)	Weekly	Monthly (Note 1)	Yearly/Seasonal (Note 2)
General:			
Reading of operating data (Note 3)	X		
Visual inspection of unit for any damage and/or loosening		X	
Verification of thermal insulation integrity		X	
Cleaning		X	
Paint where necessary			X
Analysis of water (4)			X
Check of flow switch operation		X	
Electrical Installation:			
Verification of control sequence			X
Verify contactor wear – Replace if necessary			X
Verify that all electrical terminals are tight – Tighten if necessary			X
Clean inside the electrical control board		X	
Visual inspection of components for any signs of overheating		X	
Verify operation of compressor and electrical resistance		X	
Measure compressor motor insulation			X
Refrigeration circuit:			
Check for any refrigerant leakage (leak test)		X	
Analyze compressor vibrations			X
Hydraulic circuit:			
Check for any water leakage		X	
Check hydraulic connections		X	
Check the pressure at the pump inlet		X	
Clean the water filter			X
Check the glycol concentration			X
Check the water flow rate		X	
Check the safety valve			X
Coil section:			
Checking the cleaning of the air heat exchanger (Note 6)		X	
Check the cleaning of water heat exchangers (Note 6)			X
Verify that fans are well tightened			X
Verify coil fins		X	
BPHE:			
Check the cleaning of the BPHE			X

Table 11 – Routine Maintenance Plan for Critical Application and/or Highly Aggressive Environment

Notes:

7. Monthly activities include all the weekly ones.
8. The annual (or early season) activities include all weekly and monthly activities.
9. Daily reading of the operating values of the unit allows maintaining high observational standards.
10. Check for any dissolved metals.
11. Clean condenser banks with clean water and water heat exchangers with appropriate chemicals. Particles and fibers could clog up the exchangers, especially for water exchangers pay attention if water rich in calcium carbonate is used. An increase in pressure drops or a decrease in thermal efficiency means that the heat exchangers are clogged. In environments with a high concentration of airborne particles, it might be necessary to clean the condenser bank more often.
12. Units placed or stored in a Highly Aggressive Environment for long time without operation are still subject to those routine maintenance steps.

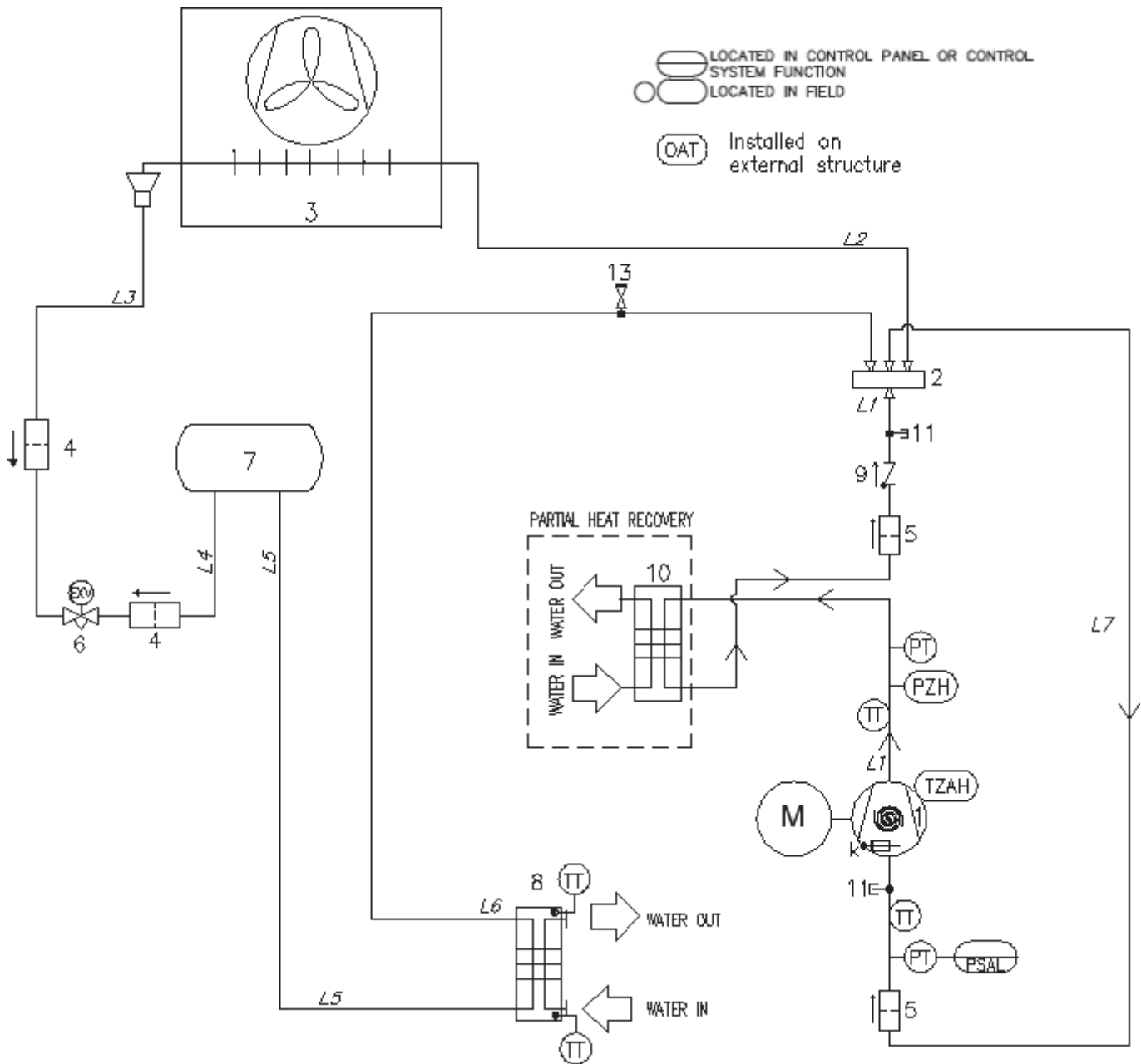

Figure 19 – Refrigerant circuit (P&ID) diagram for MONO circuit EWYT-CZ unit

REFRIGERANT	PED GROUP	LINE	PS (bar)	Ts (°C)
R32	1	HIGH PRESSURE GAS	42.9	+10/+120
		HIGH PRESSURE LIQ	42.9	-10/+65
		LOW PRESSURE	30	-30/+60

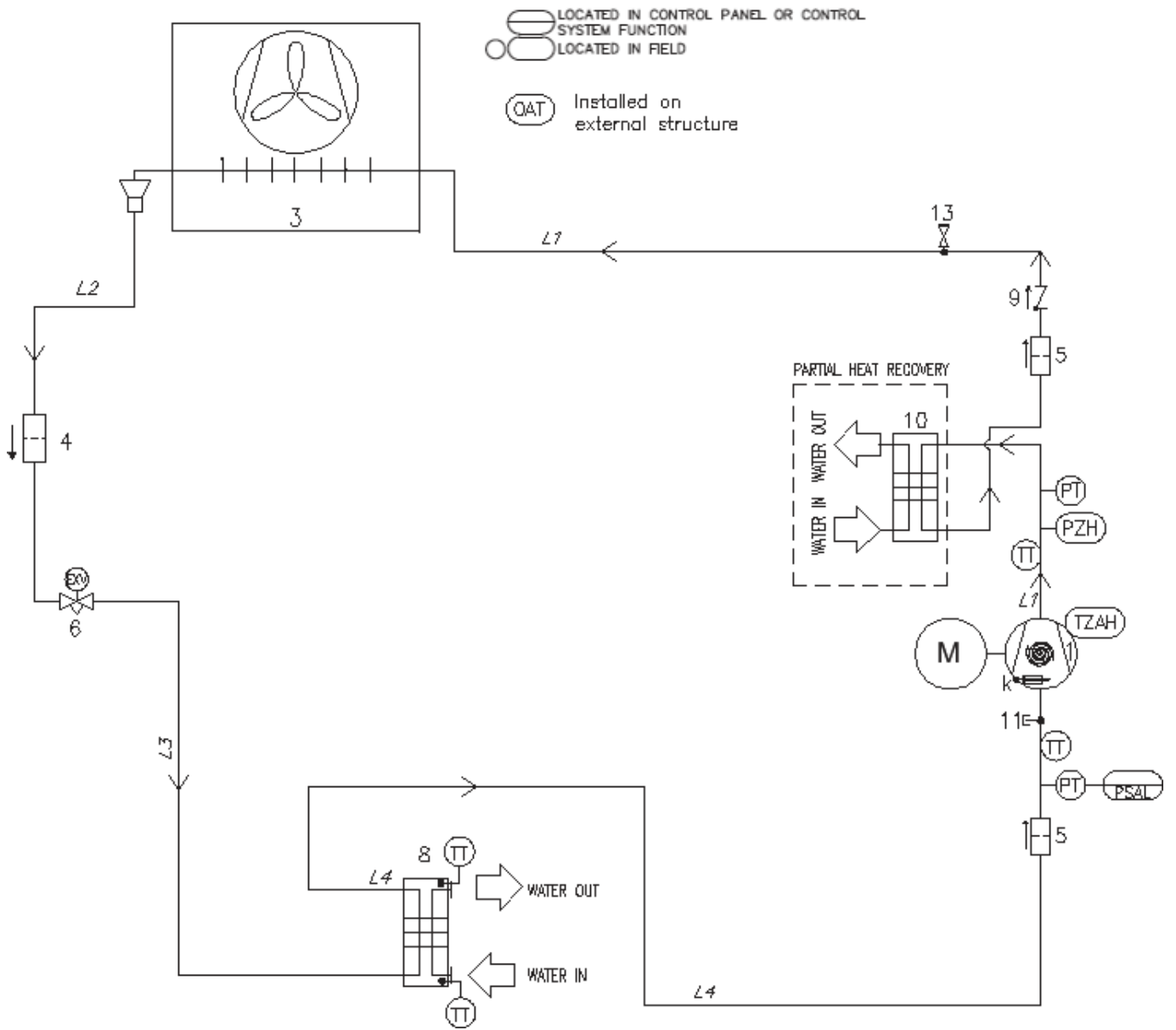

Figure 20 – Refrigerant circuit (P&ID) diagram for MONO circuit EWAT~CZ unit

REFRIGERANT	PED GROUP	LINE	PS (bar)	Ts (°C)
R32	1	HIGH PRESSURE GAS	42.9	+10/+120
		HIGH PRESSURE LIQ	42.9	-10/+65
		LOW PRESSURE	30	-30/+60

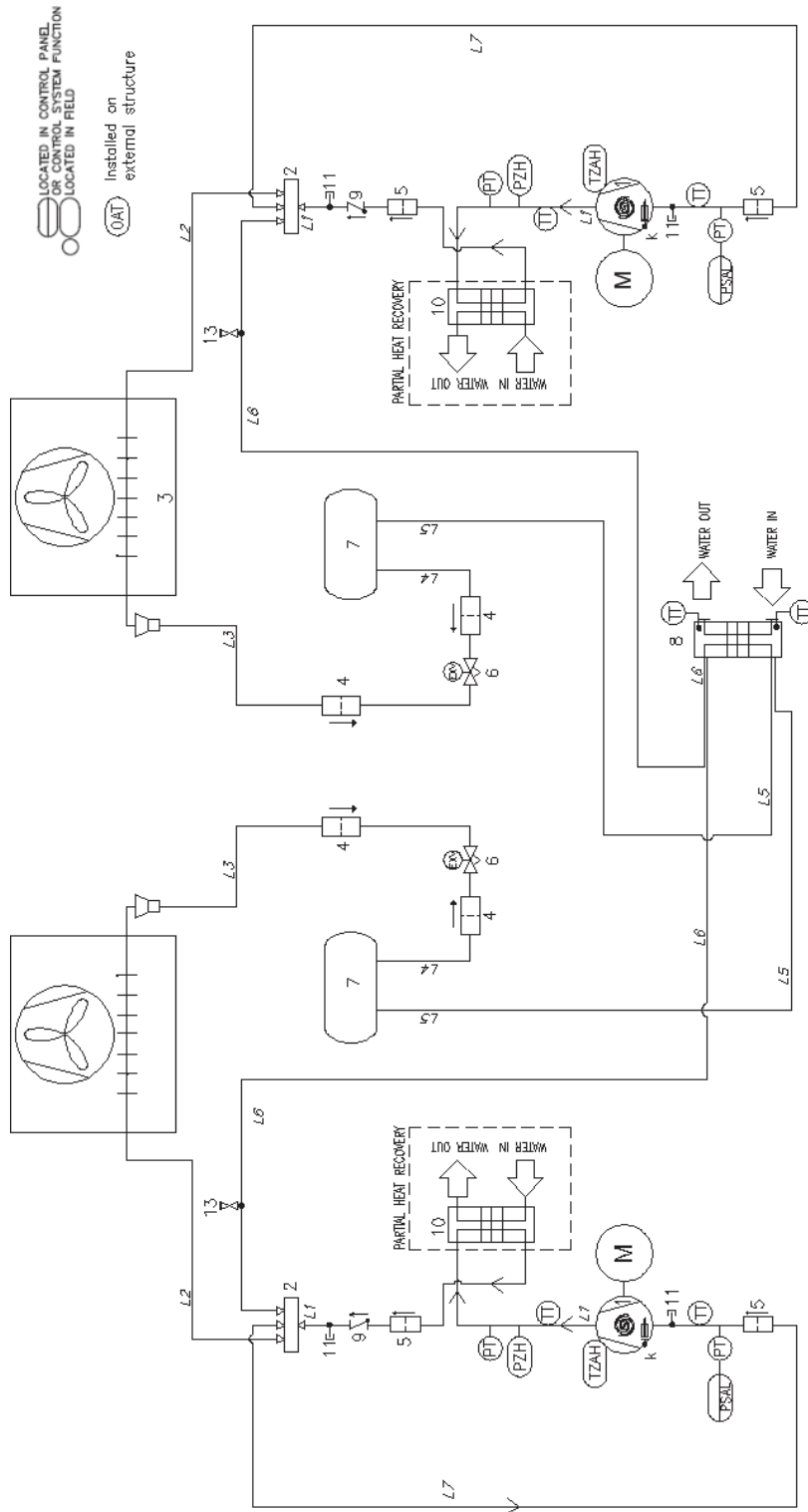

Figure 21 – Refrigerant circuit (P&ID) diagram for DUAL circuit EWYT~CZ unit

REFRIGERANT	PED GROUP	LINE	PS (bar)	Ts (°C)
R32	1	HIGH PRESSURE GAS	42.9	+10/+120
		HIGH PRESSURE LIQ	42.9	-10/+65
		LOW PRESSURE	30	-30/+60

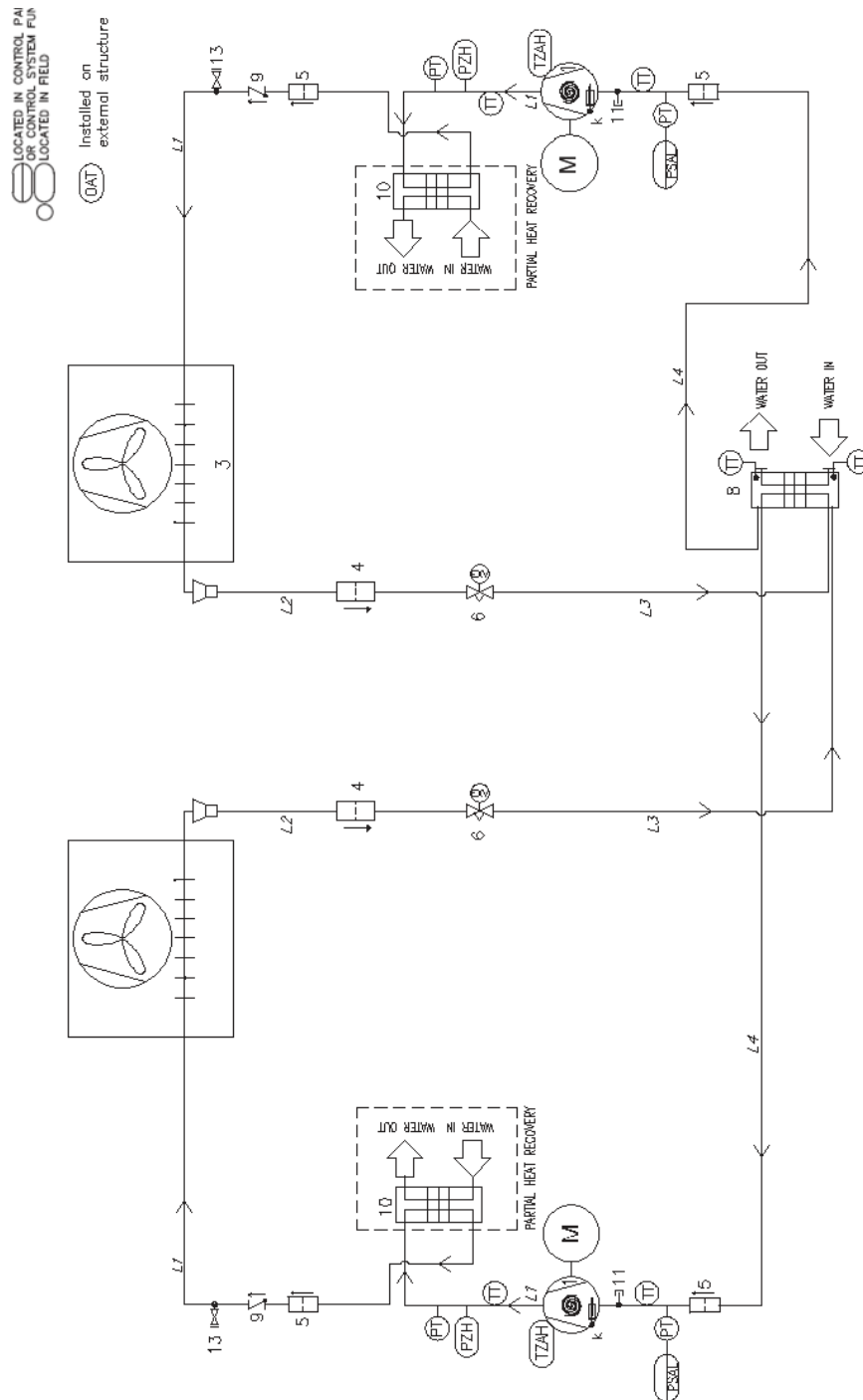

Figure 22 – Refrigerant circuit (P&ID) diagram for DUAL circuit EWAT-CZ unit











REFRIGERANT	PED GROUP	LINE	PS (bar)	Ts (°C)
R32	1	HIGH PRESSURE GAS	42.9	+10/+120
		HIGH PRESSURE LIQ	42.9	-10/+65
		LOW PRESSURE	30	-30/+60

Item	Description
1	Scroll compressors
2	Fourway valve
3	Tube&fins heat exchanger (coil)
4	Biflux filter
5	Mechanical filter
6	Electronic expansion valve
7	Liquid receiver
8	Heat exchanger BPHE
9	Check valve
11	Access fitting
13	Receiver valve
K	Crankcase heater

Water inlet and outlet are indicative. Please refer to the machine dimensional diagrams for exact water connections.

The series is composed by mono (one circuit) and dual (two circuits) reversible unit.

8. LIST OF THE LABELS APPLIED TO THE UNIT

Labels	Description	Location
	① General warning	On the electric panel (outside)
	② Hazardous voltage warning	On the electric panel (outside)
	③ A2L symbol	On the electric panel (outside)
	④ Manufacturer's logo	On the electric panel (outside)
	⑤ Lifting instruction*	One on the unit frame and one on the packaging
	⑥ Lift point label	One on the unit panel near the unit lifting holes
	⑦ Unit ID plate information	On the unit frame (outside)
	⑧ UN 3358 labels*	On the packaging
	⑨ Water outlet	On the unit panel near the outlet connection
	⑩ Water inlet	On the unit panel near the inlet connection

* Labels on the unit packaging

Table 12 – Labels applied to the Unit

With the exception of the unit's identification plate, which is always in the same position, the other plates may be located in different positions depending on the model and the options present on the unit.

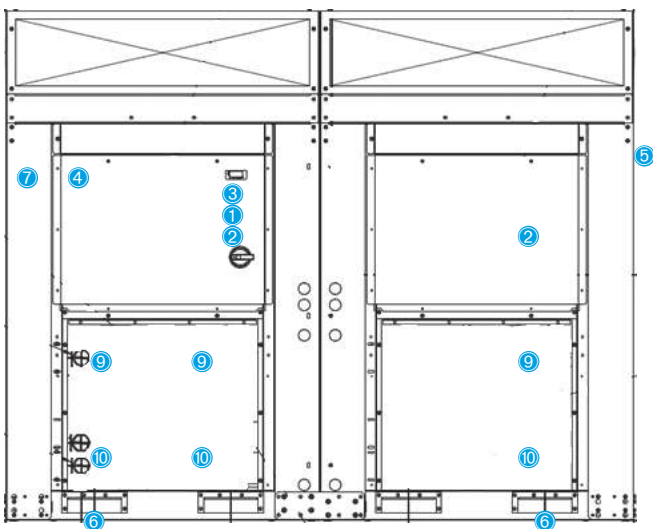

Figure 23 – Labels on the unit

9. COMMISSIONING



Only authorized DAIKIN personnel should conduct commissioning.

This general commissioning checklist can be used as a guideline and reporting template during the commissioning and hand-over to the user.

For more detailed commissioning instructions, please contact the local Daikin Service department or authorized representative of the manufacturer.

General	Yes	No	N/A
Check for external damage	<input type="checkbox"/>	<input type="checkbox"/>	<input type="checkbox"/>
Open all isolation and / or shutoff valves	<input type="checkbox"/>	<input type="checkbox"/>	<input type="checkbox"/>
Verify that the unit is pressurized with refrigerant in all of its parts before making the connection to the hydraulic circuit	<input type="checkbox"/>	<input type="checkbox"/>	<input type="checkbox"/>
Chilled Water	Yes	No	N/A
Piping complete	<input type="checkbox"/>	<input type="checkbox"/>	<input type="checkbox"/>
Water System filled and vented	<input type="checkbox"/>	<input type="checkbox"/>	<input type="checkbox"/>
Pumps installed & operational (rotation checked)	<input type="checkbox"/>	<input type="checkbox"/>	<input type="checkbox"/>
Strainers installed and clean	<input type="checkbox"/>	<input type="checkbox"/>	<input type="checkbox"/>
Controls (3way valves, bypass valves, etc.) operable	<input type="checkbox"/>	<input type="checkbox"/>	<input type="checkbox"/>
Flow switch installed	<input type="checkbox"/>	<input type="checkbox"/>	<input type="checkbox"/>
Water system operated and flow balanced to meet unit design requirements	<input type="checkbox"/>	<input type="checkbox"/>	<input type="checkbox"/>
Proper glycol percentage for the application in accordance with Daikin specifications	<input type="checkbox"/>	<input type="checkbox"/>	<input type="checkbox"/>
Condenser Water	Yes	No	N/A
Cooling tower flushed, filled and piping vented	<input type="checkbox"/>	<input type="checkbox"/>	<input type="checkbox"/>
Pumps installed & operational (rotation checked)	<input type="checkbox"/>	<input type="checkbox"/>	<input type="checkbox"/>
Strainers installed and clean	<input type="checkbox"/>	<input type="checkbox"/>	<input type="checkbox"/>
Controls (3way valves, bypass valves, etc.) operable	<input type="checkbox"/>	<input type="checkbox"/>	<input type="checkbox"/>
Water system operated and flow balanced to meet unit design requirements	<input type="checkbox"/>	<input type="checkbox"/>	<input type="checkbox"/>
Proper glycol percentage for the application in accordance with Daikin specifications	<input type="checkbox"/>	<input type="checkbox"/>	<input type="checkbox"/>
Electrical	Yes	No	N/A
Power leads connected to unit main terminal block	<input type="checkbox"/>	<input type="checkbox"/>	<input type="checkbox"/>
Power leads have been checked for proper electrical phasing UVW for L1, L2, & L3 respectively	<input type="checkbox"/>	<input type="checkbox"/>	<input type="checkbox"/>
All interlock wiring complete and complies with Daikin specifications	<input type="checkbox"/>	<input type="checkbox"/>	<input type="checkbox"/>
Pump starter and interlocks wired	<input type="checkbox"/>	<input type="checkbox"/>	<input type="checkbox"/>
Cooling tower fans and controls wired	<input type="checkbox"/>	<input type="checkbox"/>	<input type="checkbox"/>
Wiring complies with National Electrical Code and local codes	<input type="checkbox"/>	<input type="checkbox"/>	<input type="checkbox"/>
Miscellaneous	Yes	No	N/A
Unit installed in accordance with Daikin IOM specifications (leveling, space requirements, ...)	<input type="checkbox"/>	<input type="checkbox"/>	<input type="checkbox"/>
Thermometer wells, thermometers, gauges, control wells, controls, etc., installed	<input type="checkbox"/>	<input type="checkbox"/>	<input type="checkbox"/>
A minimum system load of 60% of machine capacity is available for testing and adjusting controls	<input type="checkbox"/>	<input type="checkbox"/>	<input type="checkbox"/>

Table 13 – Checks before starting up the unit



NOTE This list must be completed and sent to the local Daikin Service department at least two weeks before the startup date.

10. IMPORTANT INFORMATION ON THE REFRIGERANT USED

This product contains fluorinated greenhouse gases. Do not vent gases into the atmosphere.

Refrigerant type: R32
GWP Value (global warming potential): 675

The refrigerant system is charged with fluorinated greenhouse gases and the refrigerant charge is impressed on the plate.



In Europe, the greenhouse gas emissions of the total amount of refrigerant in the system (expressed in equivalent tonnes of CO₂) is used to determine the frequency of maintenance. Follow the applicable legislation.

11. PERIODIC CHECKS AND COMMISSIONING OF PRESSURE EQUIPMENT

The units are included in category II and III of the classification established by the European Directive 2014/68/EU (PED). For units belonging to these categories, some local regulations require a periodic inspection by an authorized person. Please check with your local requirements.

12. DISMISSION AND DISPOSAL

The unit is made of metal, plastic and electronic parts. All these components must be disposed of in accordance with local disposal laws and if in scope with the national laws implementing the Directive 2012/19/EU (RAEE).

Lead batteries must be collected and sent to specific waste collection centers.

Avoid the escape of refrigerant gases into the environment by using suitable pressure vessels and tools for transferring the fluids under pressure. This operation must be carried out by competent personnel in refrigeration systems and in compliance with the laws in force in the country of installation.



NOTES

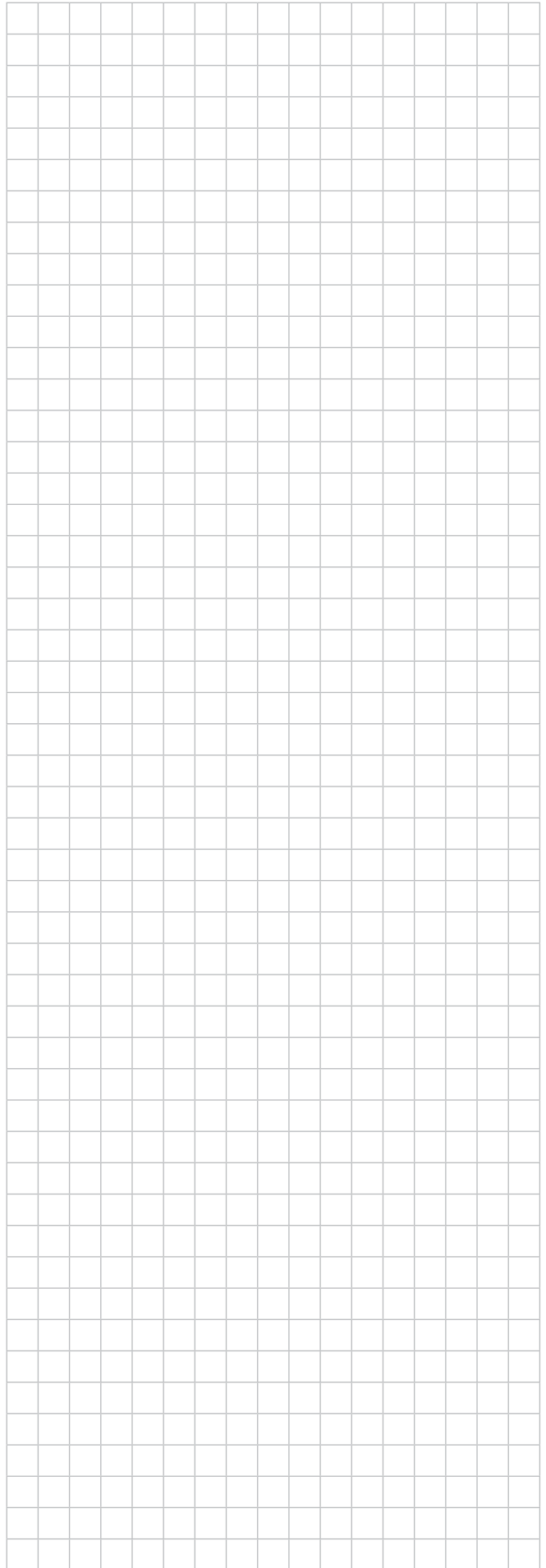
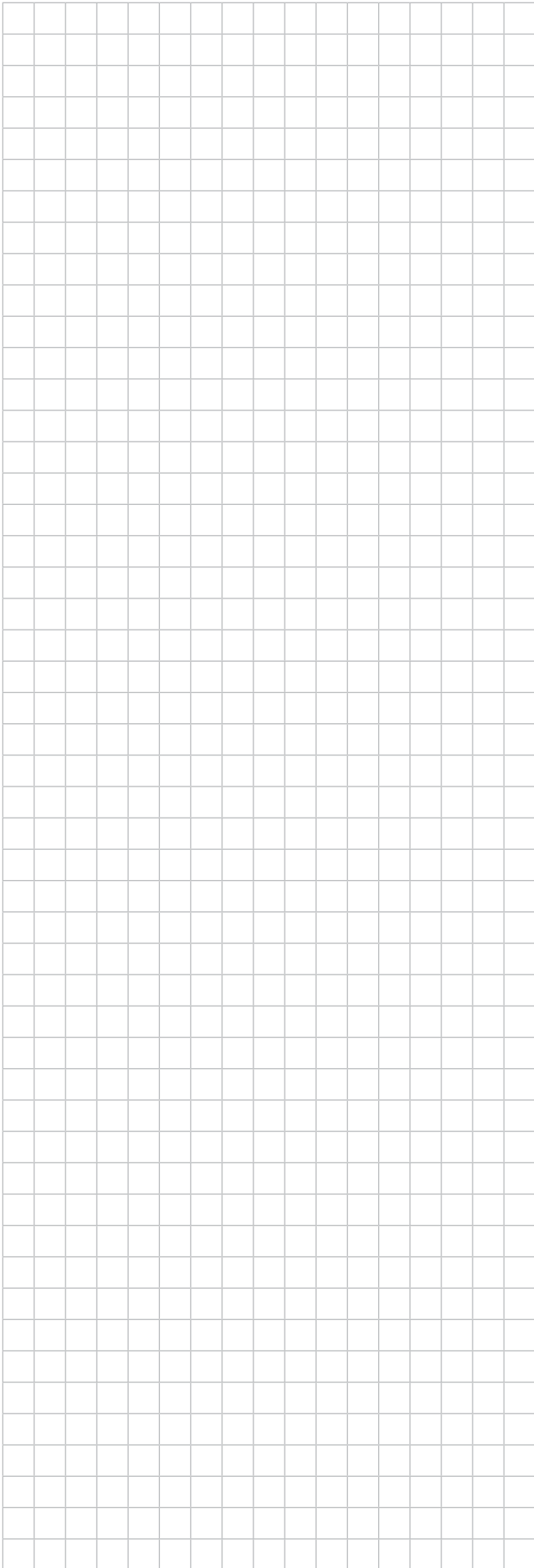

The present publication is drawn up only for technical support and it does not constitute a binding commitment for Daikin Applied Europe S.p.A.. Its content has been written by Daikin Applied Europe S.p.A. to the best of its knowledge. No explicit or implied warranty is given for the completeness, accuracy, reliability of its contents. All data and specifications contained therein may be subject to change without notice. Refer to the data communicated at the time of the order. Daikin Applied Europe S.p.A. explicitly rejects any liability for any direct or indirect damage, in the broadest sense, arising from or related to the use and/or interpretation of this publication. All content is copyrighted by Daikin Applied Europe S.p.A..

DAIKIN APPLIED EUROPE S.p.A.

Via Piani di Santa Maria, 72 00072 Ariccia (Roma) Italy
Tel: (+39) 06 93 73 11 Fax: (+39) 06 93 74 014
<http://www.daikinapplied.eu>

D-EIMHP01405-21_02EN 04/2022