



Lavabo suspendido 120x45

120x45 Wall hung basin
Lavabo 120x45 suspendu
100090016

noken
PORCELANOSA BATHROOMS

Carretera CV-20 km.2 · 12540 Vila-real · Castellón · Spain
Tel: +34 964 50 64 50 - Fax: +34 964 50 67 93
e-mail: noken@noken.com · www.noken.com

Square



- Lea atentamente estas instrucciones antes de comenzar la instalación.
- Compruebe el producto por si faltasen piezas o estuviesen dañadas.
- Cualquier alteración que se realice al sanitario invalidaría la garantía.
- Le recomendamos la instalación por parte de personal cualificado.
- En nuevas construcciones se deben llenar los sifones de inodoros, lavabos y bidets de agua para evitar que la grifería y los asientos se oxiden o amarilleen por el efecto de la subida de gases corrosivos. Se recomienda que el espacio esté muy aireado.
- Purgar las tuberías antes de la instalación.
- Compruebe el funcionamiento del mecanismo de la cisterna del inodoro.
- Gracias a un cuidado periódico se puede evitar la formación de restos calcáreos.
- Residuos de productos de aseo y limpieza pueden dañar las piezas metálicas de los sanitarios, como bisagras y embellecedores.

- Please read these instructions carefully before starting installation and retain for future reference. Please leave these instructions with the end user.
- Remove all packaging and check the product for missing parts and damages before starting the installation.
- Any alterations made to this product and its fittings may infringe the water regulations and will invalidate the guarantee.
- We strongly recommend the use of a qualified and registered plumber.
- In new buildings it is recommended to water fill the traps to ensure toxic gases do not corrode the surface of the taps and toilet seats. It is recommended that the room is well ventilated.
- Thoroughly flush through all pipe work prior to the installation of terminal appliances, e.g. Shower heads, taps, inlet valves etc.
- Factory fitted components such as inlet and outlet valves should be checked for position and tightness, they may have loosened in transit. Check the operation of the valves.
- Periodic cleaning and maintenance should be used to avoid the build up of damaging lime scale deposits.
- Bathroom harsh cleaning agent residuals may damage some materials, such as seat hinges and plastic or chrome components.

- Lire attentivement cette notice avant de commencer l'installation
- Vérifier si certaines pièces sont manquantes o abîmées.
- Toute altération qui sera effectuée à la sanitaire rendra invalide la garantie.
- Nous recommandons fortement l'installation du produit par du personnel qualifié.
- Dans le cas de constructions neuves, il faut mettre en eau les WC, lavabos et bidets pour éviter que la robinetterie et les abattants ne s'oxydent ou ne jaunissent à cause de gaz corrosif. Nous recommandons de laisser un espace très aéré.
- Purger les tuyauteries avant l'installation.
- Vérifier le fonctionnement du mécanisme du réservoir du WC.
- Grâce à un entretien régulier, on peut éviter la formation de calcaire.
- Produits résiduels des toilettes et nettoyage peuvent abimer les pièces métalliques des sanitaires, comme les charnières et enjoliveurs.





100090016_N377001044	
1	100041225_N421040000
2*	100089013_N643000004

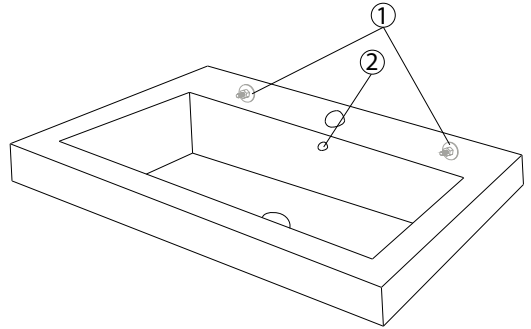

*100276175_N499817192 (Negro mate, Matt black, Noir mat)

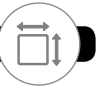

100090016_N377001044

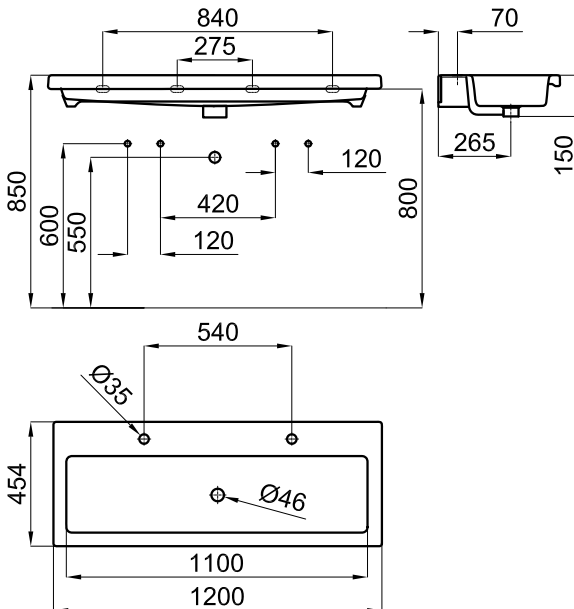



1

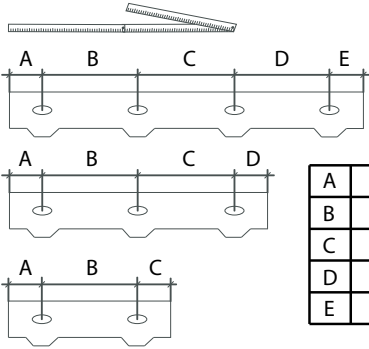

2

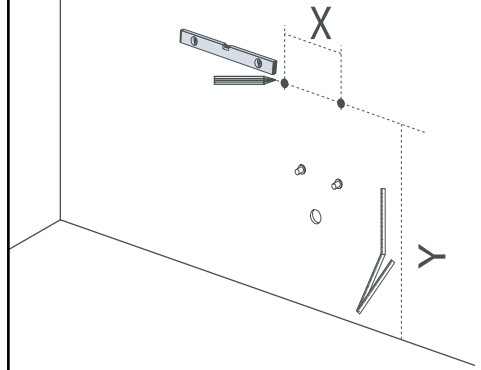

3

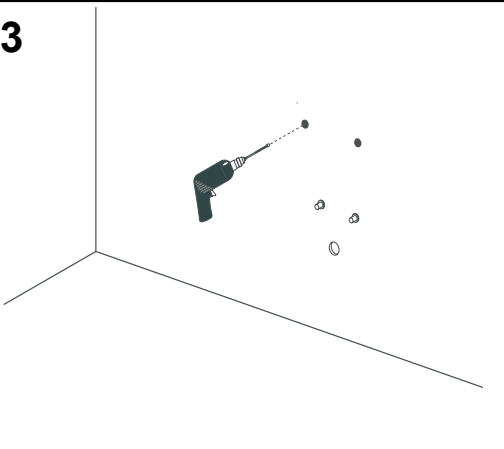

4

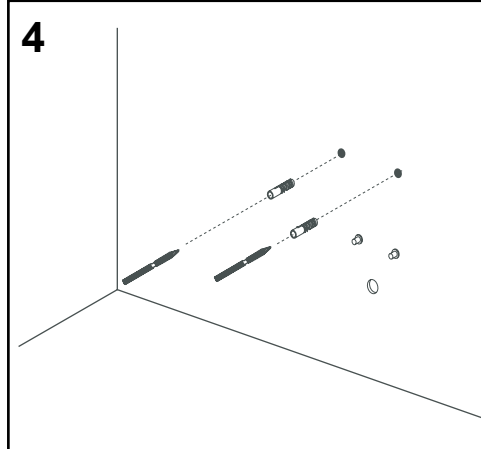

5

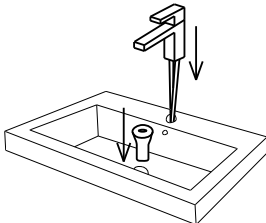

6

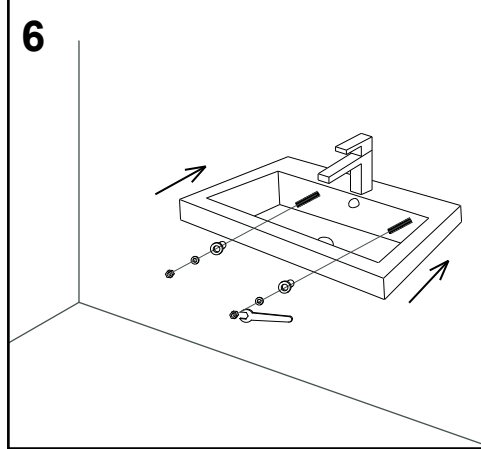



7

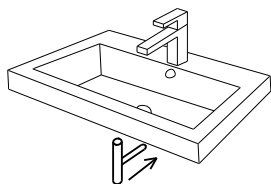

8

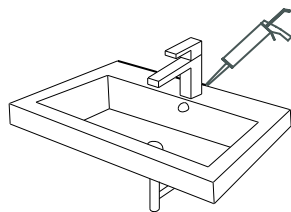

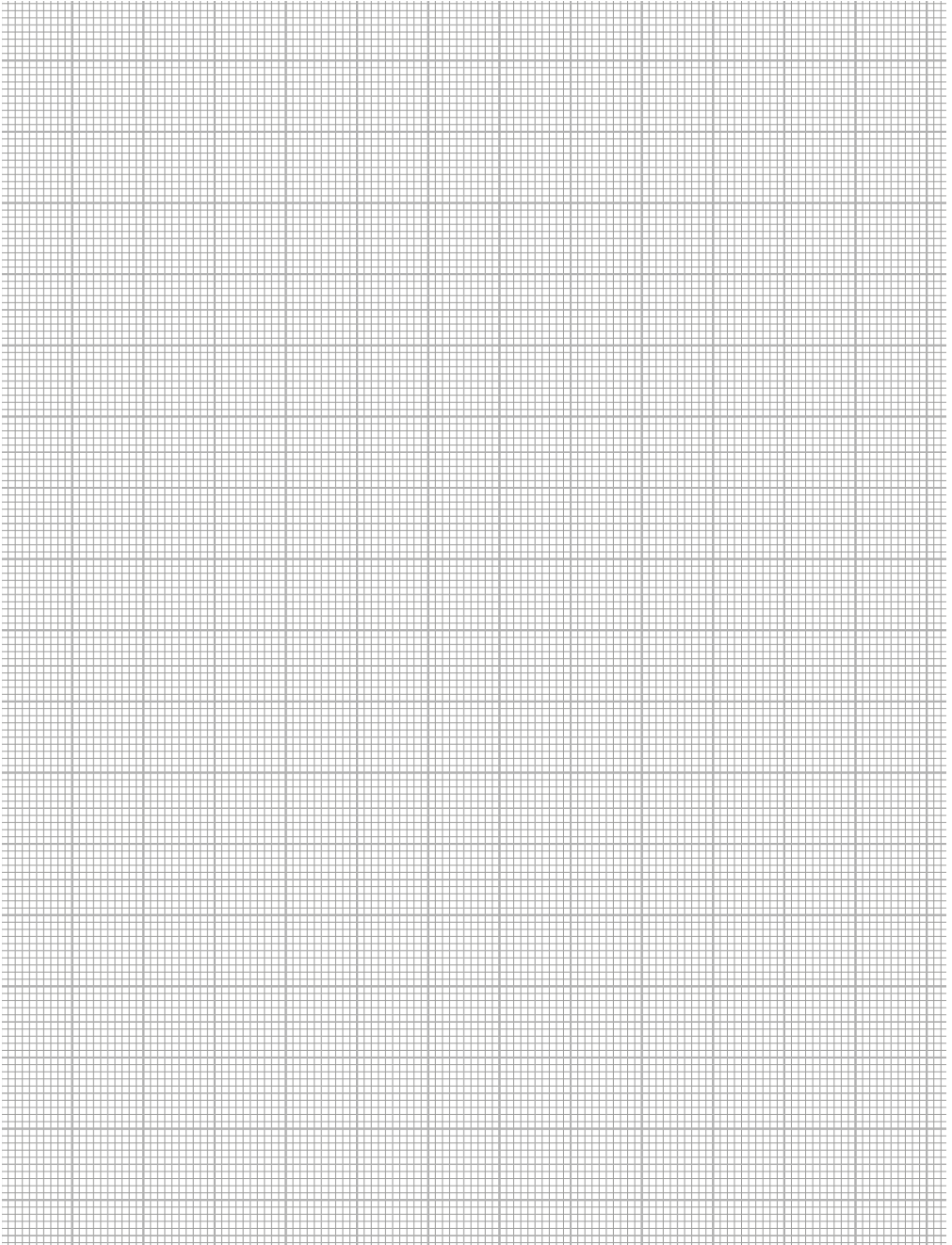

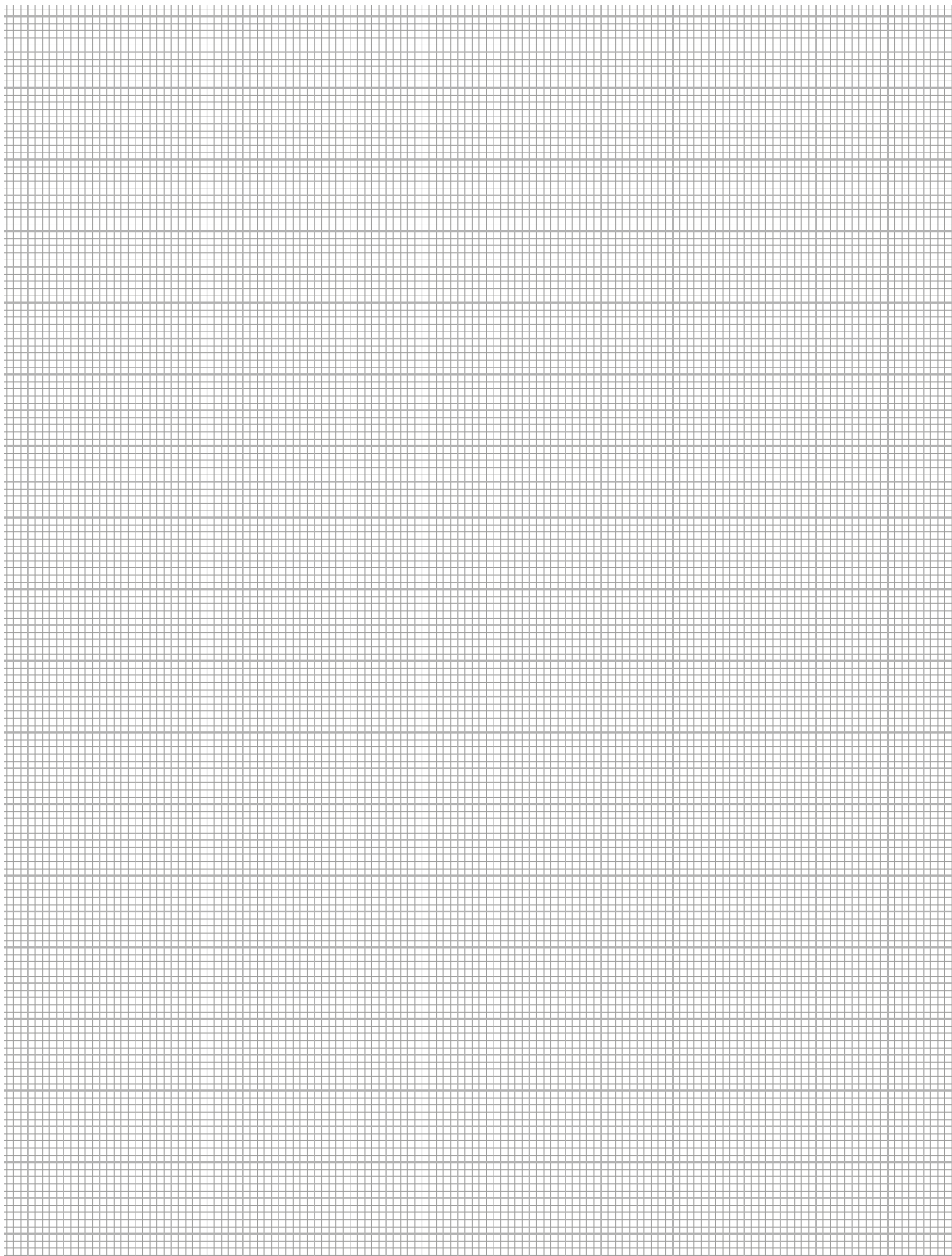

PORCELANOSA BATHROOMS



www.noken.com

Para consultar la garantía u otra información relativa a este producto, visitar nuestra web:
For a warranty or other information on this product, visit our Web address:
Pour obtenir une garantie ou d'autres informations sur ce produit, visitez notre site web
Para garantia ou outras informações sobre este produto, visite o nosso site

