

noken
PORCELANOSA BATHROOMS

Carretera CV-20 km.2 · 12540 Vila-real · Castellón · Spain
Tel: +34 964 50 64 50 - Fax: +34 964 50 67 93
e-mail: noken@noken.com · www.noken.com

BASIC



Las bañeras Noken Design han sido fabricadas con elevadas exigencias y pensando, en todo momento, en la satisfacción del usuario final. Las bañeras son montadas y puestas a prueba, una a una, superando rigurosos controles técnicos y de seguridad, en nuestras instalaciones, para verificar su correcto funcionamiento, antes de salir de fábrica. La instalación de fontanería debe hacerse de acuerdo con la reglamentación vigente en cada país para las instalaciones de fontanería en edificios. La instalación debe ser realizada exclusivamente por un instalador cualificado. La instalación se debería realizar de acuerdo con las regulaciones de cableado vigentes en su país. Asegúrese de que el circuito al que se va a conectar la bañera, haya sido instalado y protegido de acuerdo con las normas de instalación vigentes en su país. Asimismo Noken Design S.A. declina toda responsabilidad en caso de una instalación incorrecta. La máxima dureza del agua aconsejable para esta gama de bañeras es de 18°TH (Grados franceses) / 13°e (Grados ingleses). Las bañeras no han sido diseñadas para tratamientos con algas, barros, aguas marinas, etc. Cuando está húmeda, la superficie de la mayor parte de las bañeras presenta un aumento del riesgo potencial de deslizamiento. Esto es más significativo cuando se utiliza jabón, champú, aceites para el baño y otros productos similares. Es importante que los usuarios de las bañeras sean conscientes de esto.

Todo el contorno de la pestaña y la superficie del fondo, debe soportar de forma homogénea el peso total de la bañera (incluido su volumen de agua), soportándolo homogéneamente entre todos sus puntos de apoyo (suelo y apoyo de pestañas). IMPORTANTE: En bañeras sin patas, la falta de un soporte homogéneo del fondo, pudiera comportar la rotura del acrílico.

Evite todo contacto con lacas, quitaesmaltes de uñas, disolventes orgánicos, cigarrillos encendidos, cementos, etc...

Proteger la bañera hasta el fin de la obra. Se recomienda cubrirla con el embalaje original de suministro (cartón, film plástico, ...) o una tela gruesa y suave.

No limpiar con productos y estropajos abrasivos o vapor. Se recomienda solo con agua y jabón

Si en la instalación se utiliza soplete, no dirigir la llama hacia la bañera.

No recomendamos el uso de un lecho de arena sin ladrillos dado que con el tiempo pudiera ceder o modificar su sustento. Tampoco recomendamos el uso de cemento entre los ladrillos y la bañera.

IMPORTANTE: Montar las asas antes de colocar la bañera, en el caso de que dispongan de ellas.

Nuestras bañeras acrílicas se fabrican en base a la exigente norma europea UNE-EN 198, UNE EN 14516, por tanto cumplen con todos los ensayos de resistencia, planitud y desviaciones que en ella se dictan, así como a conformidad y el marcado CE.

El presente documento tiene por objeto proporcionar información genérica sobre el tema tratado y se facilita con el entendimiento de que no proporciona información para ser tratada ante un marco jurídico o legal. Puede encontrar los documentos de garantía completos en nuestra página web: www.noken.com

Nota: -Revisar el material a su llegada, y si se advierte algún desperfecto reclamar de inmediato al transportista.

-Verificar el producto, y el perfecto estado de sus componentes antes de realizar la instalación. Si se advierte algún defecto, proceder a la reclamación antes de la instalación.

Advertencia: Es necesario, el acceso total a las partes no visibles de la bañera, con el fin de poder realizar futuras tareas de mantenimiento.

Noken Design baths are manufactured to the strictest standards to ensure quality performance and full customer satisfaction at all times.

Each and every one of our baths is assembled and tested before leaving the factory.

All plumbing installation work should be effected in compliance with national regulations concerning plumbing installations in buildings.

The system must only be installed by qualified professionals.

The installation should be in accordance with the wiring regulations in force at your country. Make sure the circuit you are connecting to the whirltub, has been installed and protected to the installation standards in force at your country.

Noken Design S.A. declines all responsibility in the event of improper installation.

The maximum recommended water hardness for the range of baths is 18°TH (French degree of hardness) / 13°e (English degree of hardness).

The baths are not designed to be used for seaweed, mud or seawater treatments, etc.

There is an increased risk of falls when the surface of most baths is wet and therefore slippery. This is particularly true when soap, shampoo, bath oils and other similar products are used. Users of baths must be aware of this fact.

The entire contour of the flange and the bottom surface must support the total weight of the bathtub (including its volume of water) consistently, supporting it homogeneously among all its support points (floor and flange support). IMPORTANT: In bathtubs without legs, the lack of a homogeneous support of the bottom, could lead to the breakage of the acrylic.

Avoid all contact with lacquers, nail polish removers, organic solvents, lighted cigarettes, cements, etc ...

Protect the bathtub until the end of the construction time. It is recommended to cover it with the original supply packaging (cardboard, plastic film, ...) or a thick and soft cover.

Do not clean with abrasive products or scourers or steam. It is recommended only with soap and water.

If the installation uses a torch, do not direct the flame towards the bathtub.

We do not recommend the use of a base of sand without bricks since in time it could yield or modify its sustenance. We also do not recommend the use of cement between the bricks and the bathtub.

IMPORTANT: Assemble the handles before placing the bathtub, in case you have them.

Our acrylic bathtubs are manufactured on the basis of the stringent European standard UNE-EN 198, UNE EN 14516, therefore comply with all resistance tests, flatness and deviations that are dictated, as well as compliance and CE marking.

The purpose of this document is to provide generic information on the subject matter and is facilitated with the understanding that it does not provide information to be treated in a legal framework. You can find the full warranty documents on our website: www.noken.com

NB: -Check the goods upon arrival, if any damage is detected notify the carrier immediately.

-Before proceeding with the installation, check that full product supplied and their parts are in perfect condition. If a defect is noticed, proceed with the claim before installing.

Caution: It is necessary, to have an access to invisible parts of the bathtub in order to be able to make future maintenance.



Les baignoires Noken Design sont fabriquées selon des critères de qualité très exigeants afin de garantir la satisfaction de l'utilisateur final. Les baignoires sont montées et testées une par une dans nos installations, et soumises à de rigoureux contrôles techniques et de sécurité, pour nous assurer qu'elles fonctionnent correctement avant d'abandonner l'usine.

Les travaux de plomberie doivent être effectués conformément aux réglementations en vigueur dans chaque pays pour les installations de plomberie dans les bâtiments.

L'installation ne peut être réalisée que par un installateur qualifié uniquement.

L'installation devra être réalisée en accord avec les régularisations de câblage en vigueur dans votre pays. Assurez vous que le circuit auquel sera branché le bain, ait été installé et protégé en accord avec les normes d'installation en vigueur dans votre pays.

Noken Design S.A. décline toute responsabilité en cas d'installation incorrecte.

La dureté maximale recommandée de l'eau pour la gamme de baignoires est de 18°TH (Degrés français) / 13°e (Degrés anglais).

Les baignoires n'ont pas été conçues pour les traitements aux algues, aux boues, aux eaux marines, etc.

Lorsqu'elle est humide, la surface de la plupart des baignoires présente un risque potentiel accru de dérapage. Ce risque est plus important en cas d'utilisation de savons, de shampoings, d'huiles pour le bain et d'autres produits similaires. Il est très important que les utilisateurs des baignoires en soient conscients.

L'ensemble du contour et de la surface inférieure de la baignoire doit supporter le poids total de la baignoire (compris son volume d'eau) de manière homogène. IMPORTANT: Dans les baignoires sans pattes, l'absence de support homogène du fond pourrait entraîner la casse de l'acrylique.

Éviter tout contact avec des laques, dissolvant pour vernis à ongles, solvants organiques, cigarettes allumées, ciments, bétons, etc.

Protégez la baignoire jusqu'à la fin des travaux. Il est recommandé de le recouvrir avec l'emballage d'origine (carton, film plastique, ...) ou bien un chiffon épais et doux.

Ne pas nettoyer avec des produits abrasifs, gratte-éponges ou bien vapeur. Il est recommandé uniquement avec du savon et de l'eau.

Si pendant l'installation il est nécessaire de faire servir une torche de soudage, ne dirigez pas la flamme vers la baignoire.

Nous déconseillons l'utilisation d'un lit de sable sans briques, car avec le temps, il pourrait se produire un modification de la capacité de portance de la baignoire. Nous déconseillons également l'utilisation de ciment, béton, etc entre les briques et la baignoire.

IMPORTANT: Installer les poignées avant de placer la baignoire, au cas où vous en auriez.

Nos baignoires acryliques sont fabriquées sur la base des rigoureuses normes européennes **UNE-EN 198, UNE EN 14516**; et satisfont les exigences des essais de résistance, planéité et déviation requis, ainsi qu'au marquage CE.

Ce document est destiné à fournir des informations générales sur le sujet traité et il est disponible, étant entendu qu'il ne donne pas de conseils juridiques. Vous pouvez trouver les documents de garantie complets sur notre site Web: www.noken.com

Remarque: -Vérifiez les marchandises à l'arrivée, si un dommage est détecté adresser immédiatement une réclamation au transporteur.

-Avant de procéder à l'installation, vérifiez que le produit complet fourni et leurs pièces sont en parfait état. Si un défaut est remarqué, suite à la réclamation avant l'installation.

Attention: C'est nécessaire l'accès total à toutes les parties pas visibles de la baignoire, pour après bien pouvoir réaliser dans l'avenir les prochaines travaux de maintenance.

Banheiras Noken Design foram fabricadas com elevadas exigências e a pensar em todos os momentos e na satisfação do cliente final.

As banheiras são montadas e testadas uma a uma, superando testes técnicos e de segurança nas nossas instalações, para verificar funcionamento adequado antes de sair da fábrica.

A instalação de canalização deve estar de acordo com as normas vigentes em cada país, para a instalação de pichelaria em edifícios.

A instalação só deve ser realizada por um instalador qualificado.

Assegurar-se que o circuito onde se vai fazer a ligação ao hidromassagem, tenha sido instalado e protegido de acordo com as normativas vigentes no seu país.

Noken Design, S.A. declina qualquer responsabilidade por instalação incorreta.

A dureza máxima recomendada de água para essa gama de banheiras é 18°TH (graus franceses) / 13°e (Gaus britânicos).

As banheiras não são projetadas para tratamentos de algas, lama, água do mar, etc.

Quando molhada, a superfície da maior parte dos banhos apresenta potencial risco de escorregamento. Isto acontece com mais frequência quando se usa sabonete, shampoo, óleos de banho e produtos similares. É importante que os usuários dos banhos sejam conscientes disso.

To do o contorno do bordo e a superfície do fundo, deve suportar de forma homogênea o peso total da banheira (incluído o seu volume de água), o suporte deverá ser homogêneo entre todos os seus pontos de apoio (chão e apoio do bordo). IMPORTANTE: nas banheiras sem patas, a falta do suporte homogêneo do fundo, pode resultar na rotura do acrílico.

Evitar contato com lacados, verniz de unhas, solventes orgânicos, cigarros, cimentos, etc.

Proteger a banheira até ao final da obra. Recomenda-se cobrir com a embalagem original de transporte (cartão, filme plástico, ...) ou uma tela resistente e suave.

Não limpar com produtos ou esponjas abrasivas ou vapor. Recomenda-se apenas água e sabão neutro.

Se para a sua instalação necessitar utilizar o maçarico, não dirigir a chama na direção da banheira.

Não é recomendado o uso de uma cama de areia sem tijolos, pois com o tempo ela poderia produzir ou modificar o seu sustento. Não é também recomendado o uso de cimento entre os tijolos e a banheira.

IMPORTANTE: No caso de ter asas, aplicá-las antes de colocar a banheira

As nossas banheiras acrílicas são fabricadas ao abrigo da exigente norma europeia **UNE-EN 198, UNE EN 14516**, pelo que cumpre com todos os ensayos de resistencia, planimetría e desvíos que a mesma dita, assim como a conformidade e a marca da CE.

O objetivo deste documento é fornecer informações genéricas sobre o assunto e é facilitado com o entendimento de que ele não fornece informações a serem tratadas perante litígio legal. Podem-se encontrar os documentos completos da garantia no nosso site: www.noken.com

Nota: -Verifique os bens no momento da chegada, se o dano for detectado, imediatamente apresentar uma reclamação ao transportador. -Antes de instalar, verifique se o produto fornecido completo e peças estão em perfeitas condições. Se um defeito for observado, na sequência da queixa antes da instalação.

Advertência: É necessário, o acesso total às partes não visíveis da banheira, com o fim de poder fazer futuros trabalhos de manutenção.

i

JUEGO PATAS / LEGS KIT / JEU DE PATTES / JOGO DE PATAS

OPCIONAL - NO INCLUIDO / OPTIONAL - NOT INCLUDED / OPTION - NON INCLUS / OPCIONAL - NÃO INCLUIDO
 En caso de uso, sustituye al punto 2. / In caso of use, replace point 2. / En case d'utilisation remplacer le point 2. / Em caso de uso, substitua o ponto 2.

| BASIC | CM | 100096848 (L: 500mm) | 100060499 (L: 740mm) | 100057508 (L: 600mm) | 100056385 (PVC) | 100056386 (ACERO) |
|---|-------------------|-------------------------|-------------------------|-------------------------|--------------------|----------------------|
| TONO | 170X70 | 1 | | | | |
| | 180X80 | 1 | | | | |
| | 190X90 | 1 (opc 1) | | 1 (opc 2) | | |
| SOLEIL ROUND | D170 | 2 | | | | |
| SOLEIL SQUARE | 160X160 | 2 | | | | |
| SOLEIL OVAL | 180X90 | | 1 | | | |
| SOLEIL QUADRA | 180X80 | | 1 | | | |
| SOLEIL OFFSET | 170X120 | 2 | | | | |
| MINIMAL | 150X70 | | | 1 | | |
| | 160X70 | | | 1 | | |
| | 160X75 | | | 1 | | |
| MINIMAL XL | 170X70 | | | 1 | | |
| | 170X75 | | | 1 | | |
| | 170X80 | | 1 | | | |
| | 180X80 | | 1 | | | |
| | 190X90 | | 1 | | | |
| MINIMAL DUO | 190X120 | | 2 | | | |
| MINIMAL OFFSET | 150X75 | 1 | | | | |
| MINIMAL OVAL <i>* Includido de serie/ Included/ Inclus/ Incluído</i> | 175X80 | | | 1* | | |
| | 190X87 | | | 1* | | |
| SP ONE | 140X70 | | | 1 | | |
| | 150X70 | | | 1 | | |
| | 160X70 | | | 1 | | |
| | 160X75 | | | 1 | | |
| SP ONE XL | 170X70 | | | 1 | | |
| | 170X75 | | | 1 | | |
| | 180X80 | | 1 | | | |
| | 180X90 | | 1 | | | |
| ECOLITE | 140X70 | | | 1 | | |
| | 50X70 | | | 1 | | |
| | 160X70 | | | 1 | | |
| | 160X75 | | | 1 | | |
| | 170X70 | | | 1 | | |
| | 170X75 | | | 1 | | |
| | 180X80 | | | 1 | | |
| | 140X140 CORNER | | | | 1 | |

| BASIC | CM | 100096848 (L: 500mm) | 100060499 (L: 740mm) | 100057508 (L: 600mm) | 100056385 (PVC) | 100056386 (ACERO) |
|-------|-------------------|-------------------------|-------------------------|-------------------------|--------------------|----------------------|
| MARNE | 140X70 | | | 1 | | |
| | 50X70 | | | 1 | | |
| | 160X70 | | | 1 | | |
| | 160X75 | | | 1 | | |
| | 170X70 | | | 1 | | |
| | 170X75 | | | 1 | | |
| | 180X80 | | | 1 | | |
| | 140X140 CORNER | | | 1 | | |
| ACORE | 120x70 | | | | 1 (opc 1) | 1 (opc 2) |
| | 140x70 | | | | 1 (opc 1) | 1 (opc 2) |
| | 150x70 | | | | 1 (opc 1) | 1 (opc 2) |
| | 160x70 | | | | 1 (opc 1) | 1 (opc 2) |
| | 170x70 | | | | 1 (opc 1) | 1 (opc 2) |

A

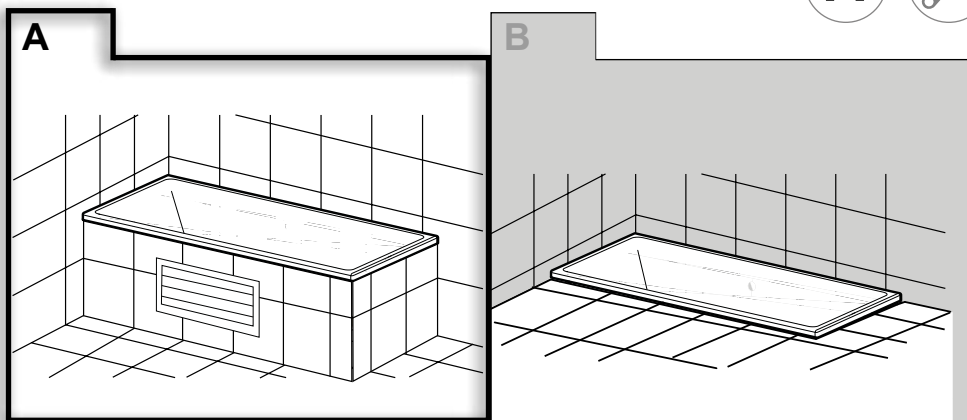

A

1

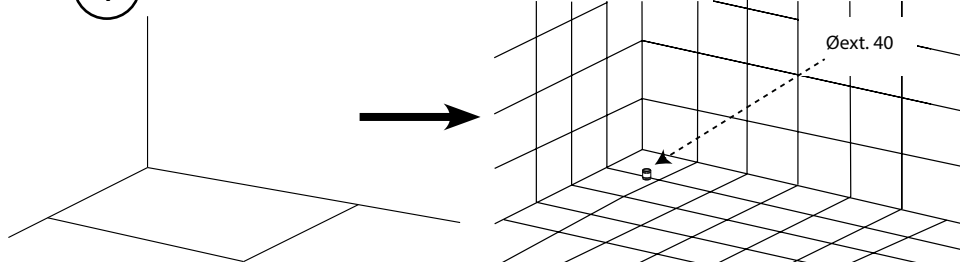



- 2**
- Nivelar a la altura elegida la bañera en su emplazamiento mediante la obra necesaria con ladrillos. Esta altura dependerá en gran parte del sistema de desagüe. **No recomendamos el uso de un lecho de arena sin ladrillos dado que con el tiempo pudiera ceder o modificar su sustento.** Tampoco recomendamos el uso de cemento entre los ladrillos y la bañera.
 - Level at the chosen height the bathtub in its location by means of the necessary work with bricks. This height will depend largely on the drainage system. **We do not recommend the use of a bed of sand without bricks since with time it could yield or modify its sustenance.** We also do not recommend the use of cement between the bricks and the bathtub.
 - Placez et niveler la baignoire dans son emplacement à la hauteur correcte à l'aide des briques. Le système de drainage doit être pris en compte au moment qu'on choisit l'hauteur. **Nous ne recommandons pas l'utilisation de sable sans les briques étant donné que la baignoire pourra modifier sa position.** Nous déconseillons également l'utilisation de ciment, béton, etc entre les briques et la baignoire.
 - Nivel na altura escolhida a banheira na sua localização por meio do trabalho necessário com tijolos. Esta altura dependerá em grande parte do sistema de drenagem. **Não recomendamos o uso de uma cama de areia sem tijolos, pois com o tempo ela poderia produzir ou modificar seu sustento.** Também não recomendamos o uso de cimento entre os tijolos e a banheira.



3 ✓

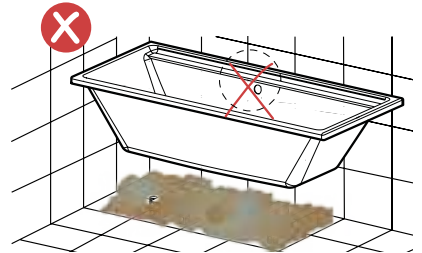
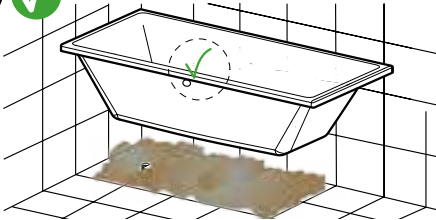

4

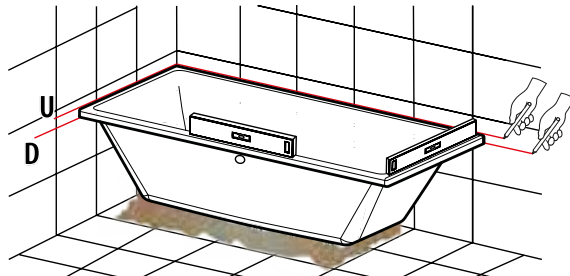
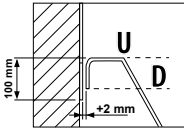

- Materiales para soporte no incluidos. El instalador será el encargado de su suministro, por tanto Noken Design declina toda responsabilidad sobre éste. La tipología del soporte, debe hacerse teniendo en cuenta las especificaciones del montaje y su ambiente (tipo de pared, peso total a soportar, materiales utilizados,...), asegurando su estabilidad en el tiempo y en el uso.
- Support materials not included. The installer will be responsible for its supply, therefore Noken Design declines all responsibility for it. The type of support, must be made taking into account the specifications of the assembly and its environment (type of wall, total weight to be supported, materials used, ...), ensuring its stability over time and in use.
- Matériel de support non inclus. L'installateur étant responsable de son approvisionnement, Noken Design décline toute responsabilité à cet égard. Le type de support doit être fait en tenant compte des spécifications de l'ensemble et de son environnement (type de mur, poids total à supporter, matériaux utilisés, ...) en assurant sa stabilité dans le temps et en utilisation.
- Materiais de suporte não incluídos. O instalador será responsável pelo seu fornecimento, portanto a Noken Design declina toda a responsabilidade por isso. O tipo de suporte deve ser feito tendo conto as especificações da montagem e seu ambiente (tipo de parede, peso total a suportar, materiais utilizados, ...), assegurando a sua estabilidade ao longo do tempo e em uso.

5A

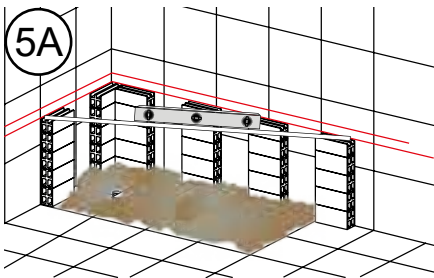

5B

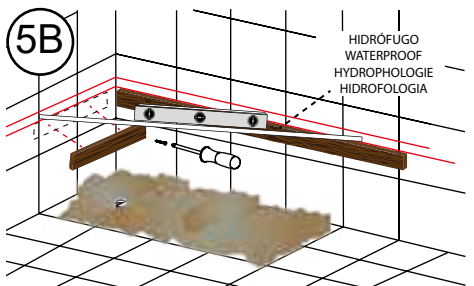



6A

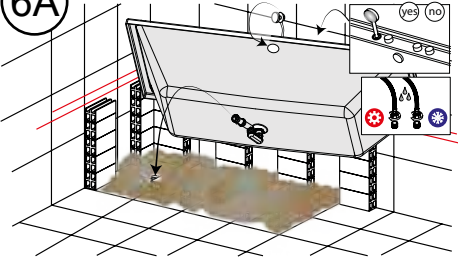

6B

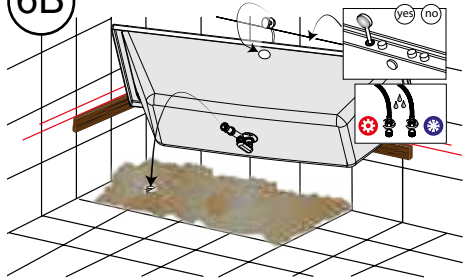

7A

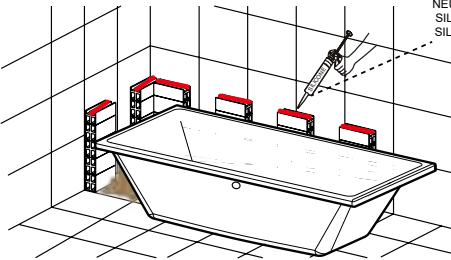

7B

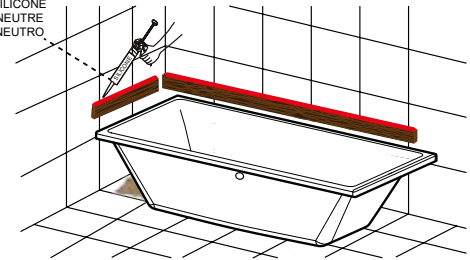

SILICONA NEUTRA
NEUTRAL SILICONE
SILICONE NEUTRE
SILICONE NEUTRO

8A

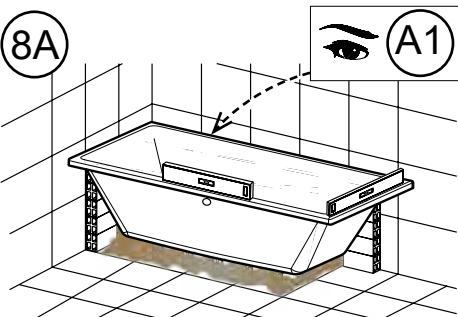

8B

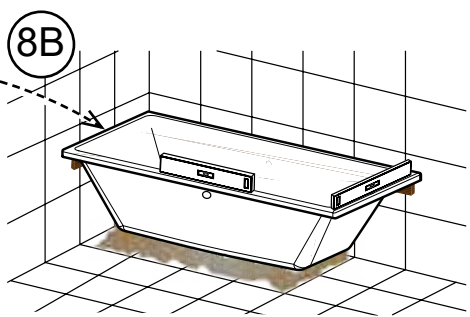



A1

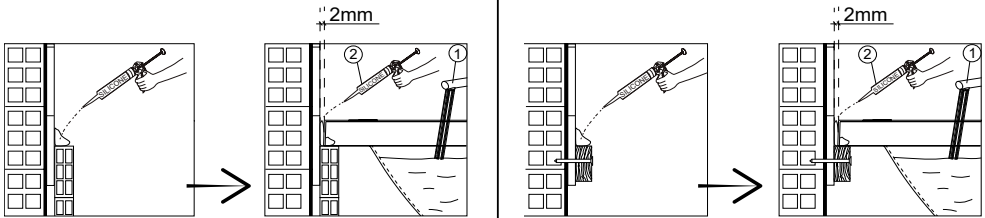

9

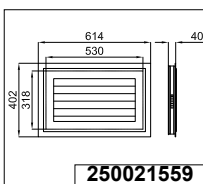
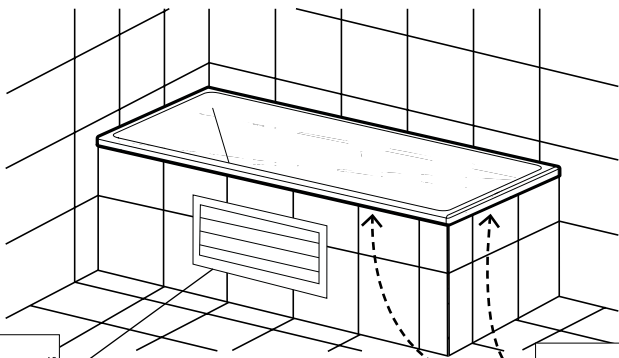

- Instale las trampillas de acceso para el mantenimiento.
- Install the access hatches for maintenance.
- Installer des trappes d'accès pour l'entretien
- Instalar escotilhas de acesso para manutenção

B1

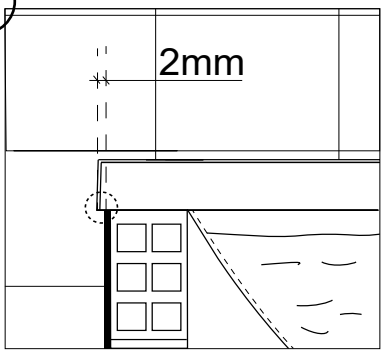

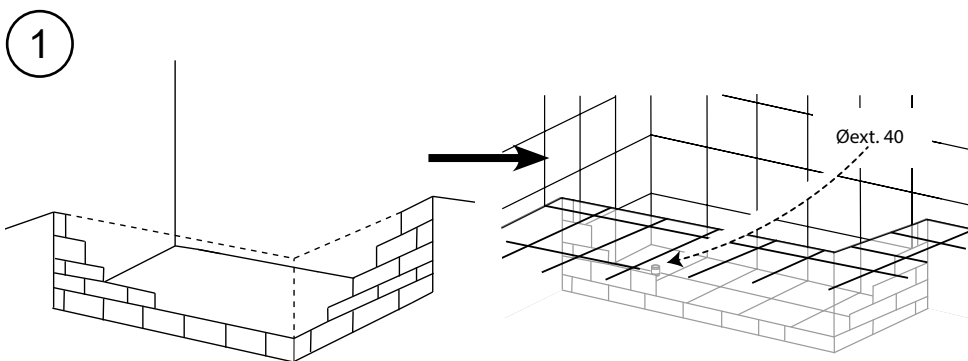
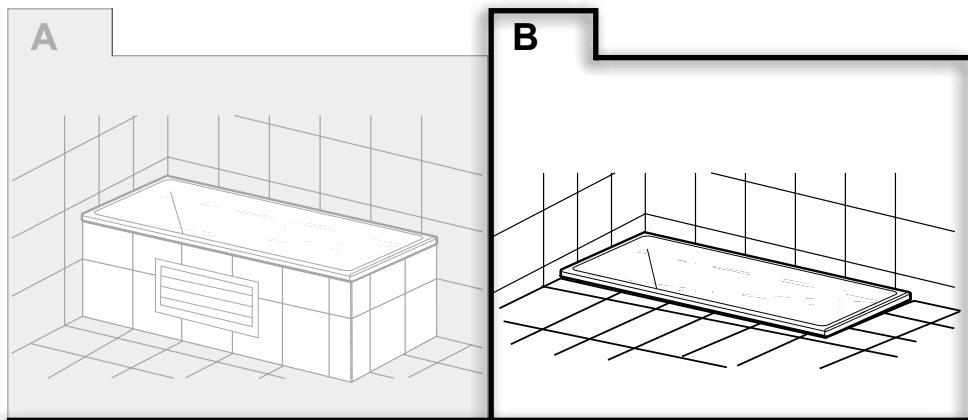



2

- Nivelar a la altura elegida la bañera en su emplazamiento mediante la obra necesaria con ladrillos. Esta altura dependerá en gran parte del sistema de desagüe. **No recomendamos el uso de un lecho de arena sin ladrillos dado que con el tiempo pudiera ceder o modificar su sustento.** Tampoco recomendamos el uso de cemento entre los ladrillos y la bañera.



- Level at the chosen height the bathtub in its location by means of the necessary work with bricks. This height will depend largely on the drainage system. **We do not recommend the use of a bed of sand without bricks since with time it could yield or modify its sustenance.** We also do not recommend the use of cement between the bricks and the bathtub.

- Placez et niveler la baignoire dans son emplacement à la hauteur correcte a l'aide des briques. Le système de drainage doit être pris en compte au moment qu'on choisit l'hauteur. **Nous ne recommandons pas l'utilisation de sable sans les briques étant donné que la baignoire pourra modifier sa position.** Nous déconseillons également l'utilisation de ciment, béton, etc entre les briques et la baignoire.

- Nivel na altura escolhida a banheira na sua localização por meio do trabalho necessário com tijolos. Esta altura dependerá em grande parte do sistema de drenagem. **Não recomendamos o uso de uma cama de areia sem tijolos, pois com o tempo ela poderia produzir ou modificar seu sustento.** Também não recomendamos o uso de cimento entre os tijolos e a banheira.

3

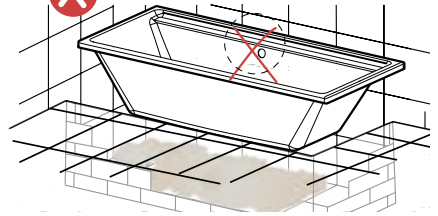
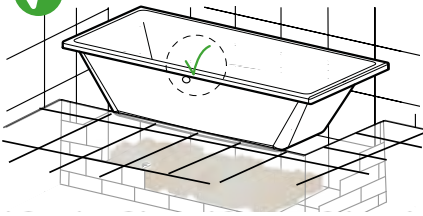

4

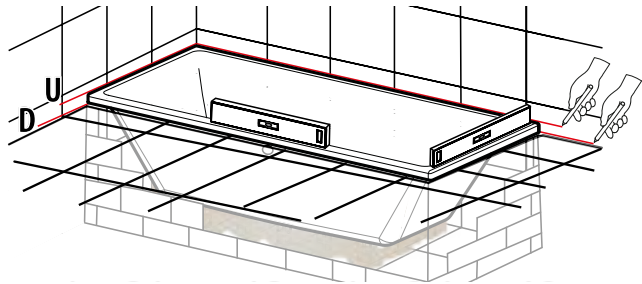
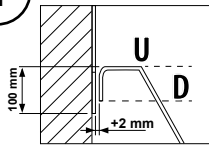

- Materiales para soporte no incluidos. El instalador será el encargado de su suministro, por tanto Noken Design declina toda responsabilidad sobre éste. La tipología del soporte, debe hacerse teniendo en cuenta las especificaciones del montaje y su ambiente (tipo de pared, peso total a soportar, materiales utilizados,...), asegurando su estabilidad en el tiempo y en el uso.

- Support materials not included. The installer will be responsible for its supply, therefore Noken Design declines all responsibility for it. The type of support, must be made taking into account the specifications of the assembly and its environment (type of wall, total weight to be supported, materials used, ...), ensuring its stability over time and in use.

- Matériel de support non inclus. L'installateur étant responsable de son approvisionnement, Noken Design décline toute responsabilité à cet égard. Le type de support doit être fait en tenant compte des spécifications de l'ensemble et de son environnement (type de mur, poids total à supporter, matériaux utilisés, ...) en assurant sa stabilité dans le temps et en utilisation.

- Materiais de suporte não incluídos. O instalador será responsável pelo seu fornecimento, portanto a Noken Design declina toda a responsabilidade por isso. O tipo de suporte deve ser feito tendo conto as especificações da montagem e seu ambiente (tipo de parede, peso total a suportar, materiais utilizados, ...), assegurando a sua estabilidade ao longo do tempo e em uso.

5A

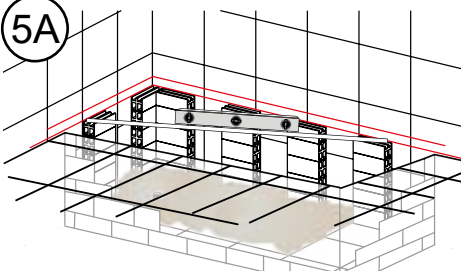

5B

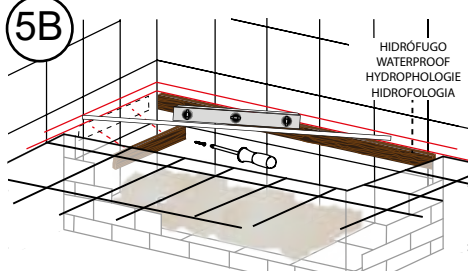

HIDRÓFUGO
WATERPROOF
HYDROFOLIE
HIDROFOLGIA



6A

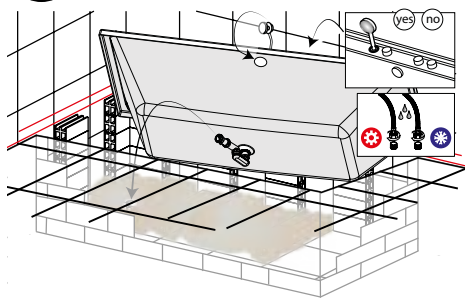

6B

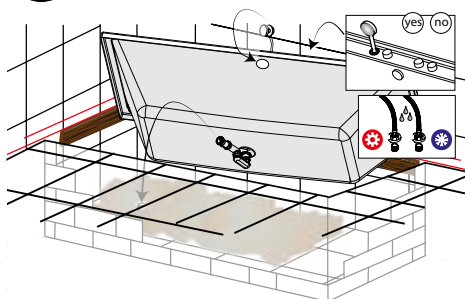

7A

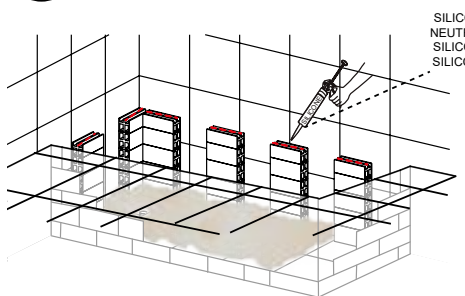

7B

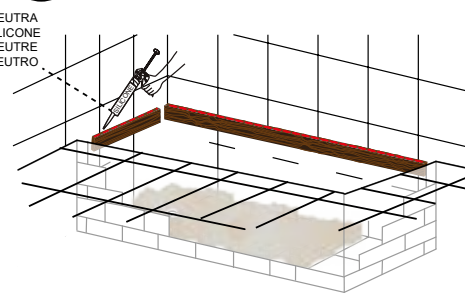

8

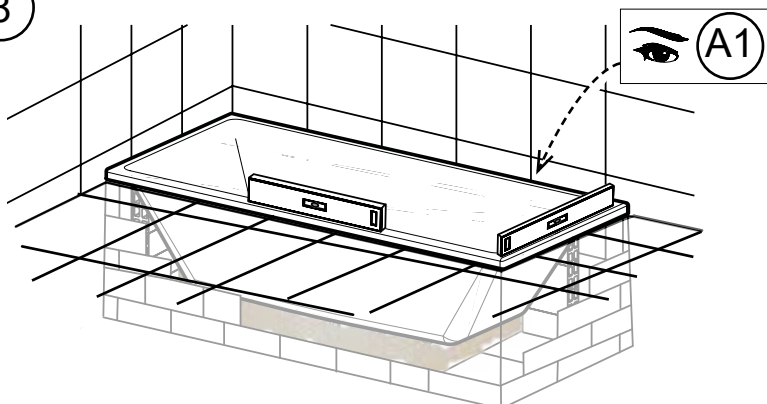



A1

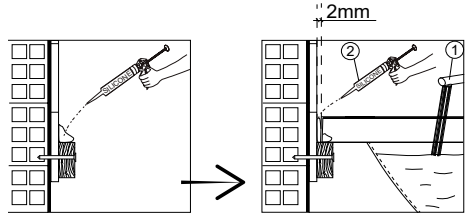
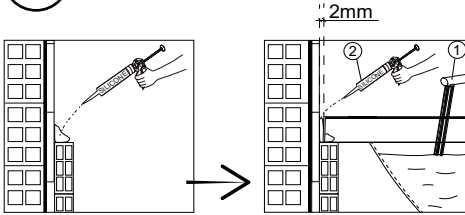

9

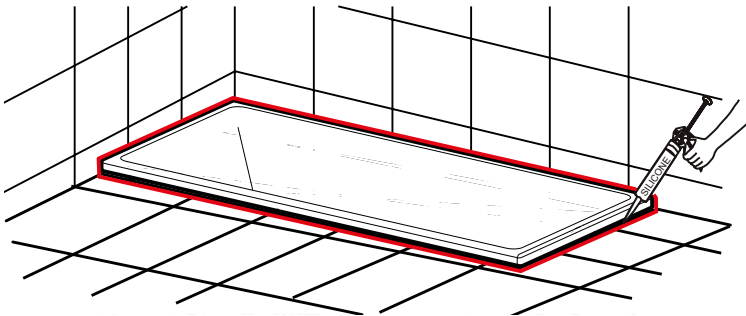

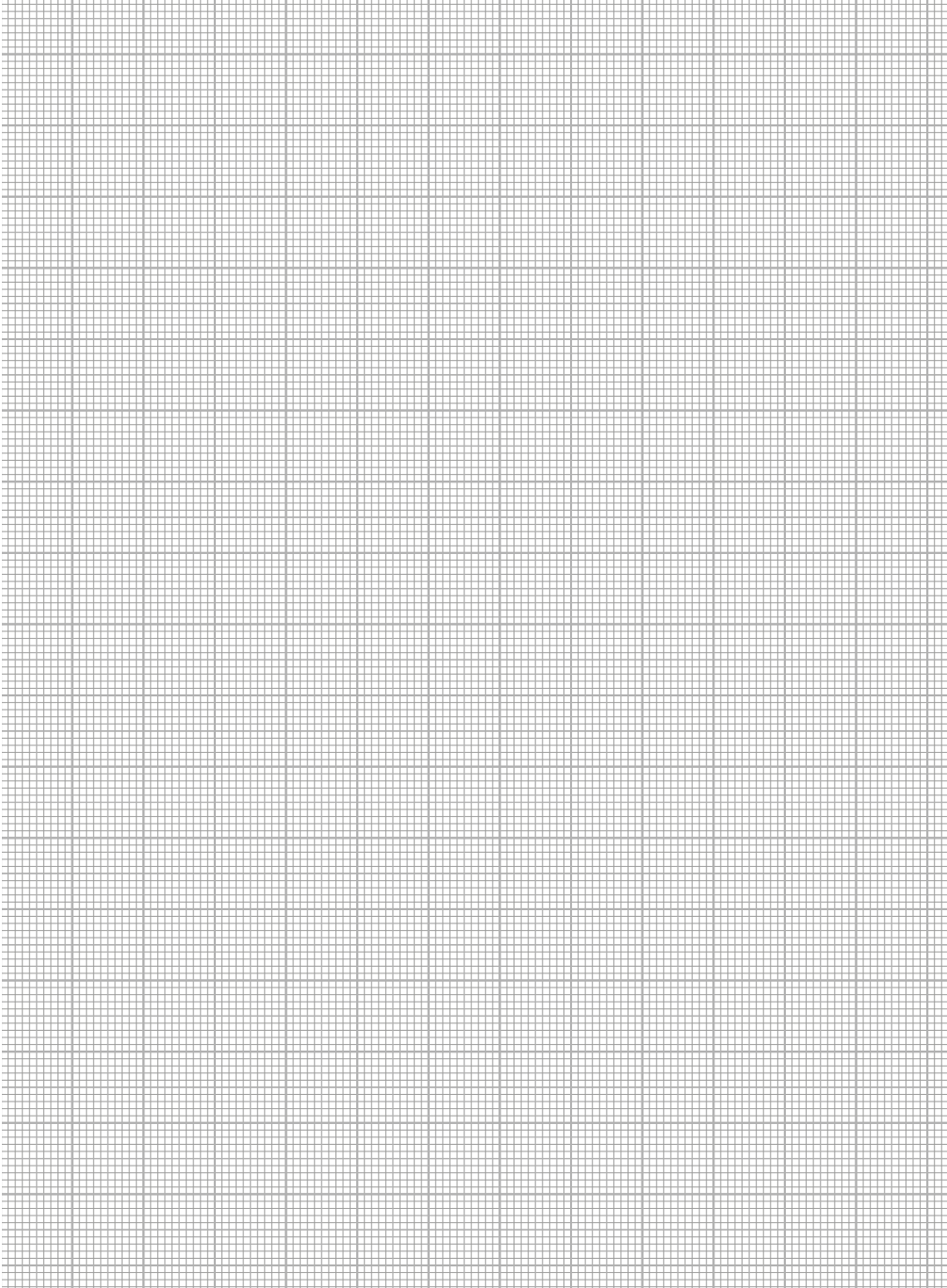

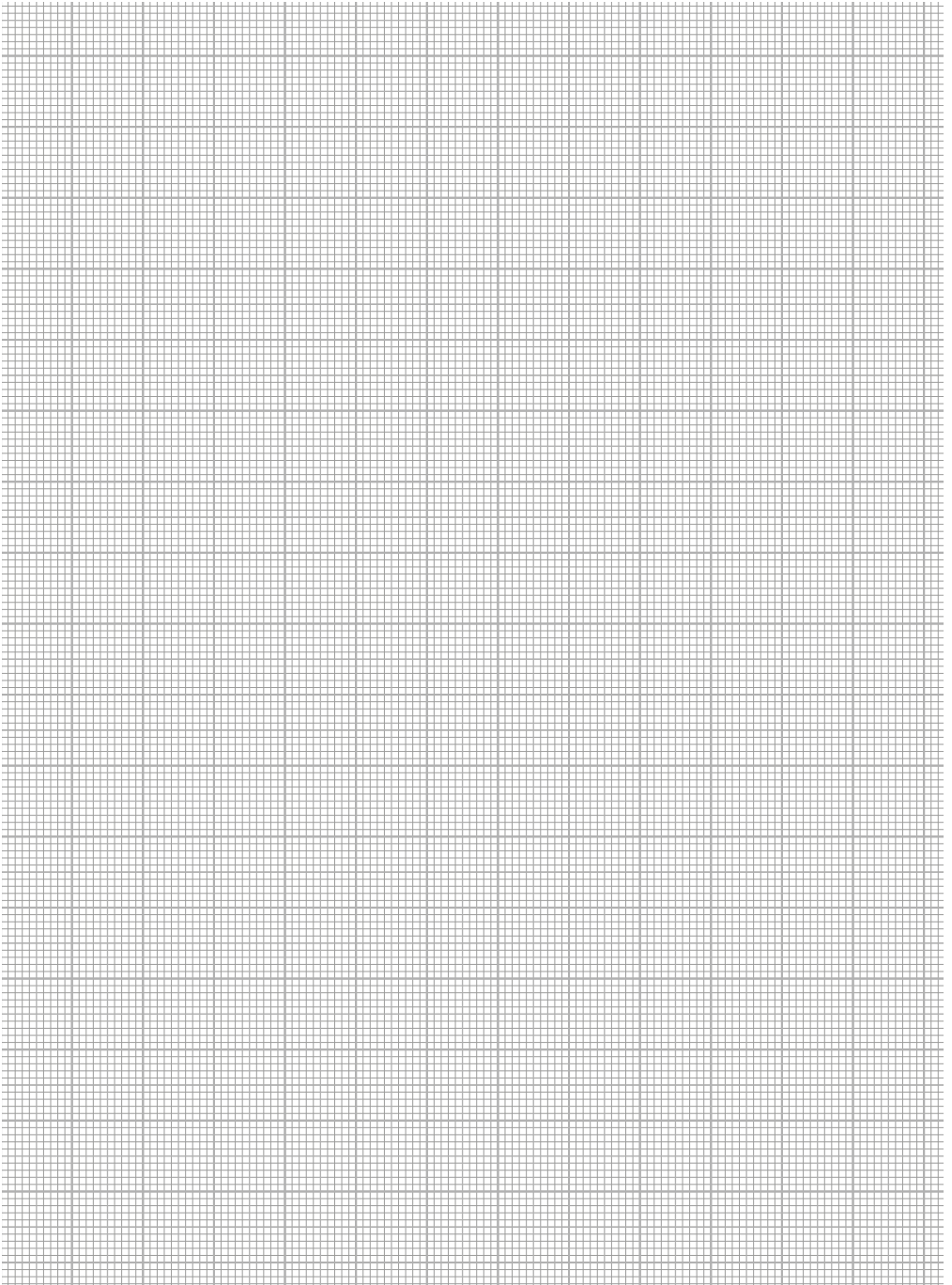

PORCELANOSA BATHROOMS



www.noken.com