

DESCRIPTION

# XT701

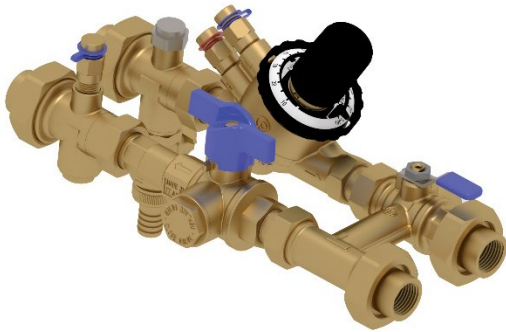

Prefabricated Commissioning Solution with 70 mm flushing bypass, **equal percentage PICV**, **Filterball®** shut off valve with integrated strainer, drain valve, air vent and additional test point.

The kit is ready to be install and provides with all components required for commissioning and operation of FCU. By-pass avoids reverse flushing across the PICV.

100% factory tested against leakage.

Fully maintainable **PICV** test point for commissioning and system optimization.

**Filterball** valve with blowout proof stem, triple sealing technology and adjustable packing gland.

DIMENSIONS

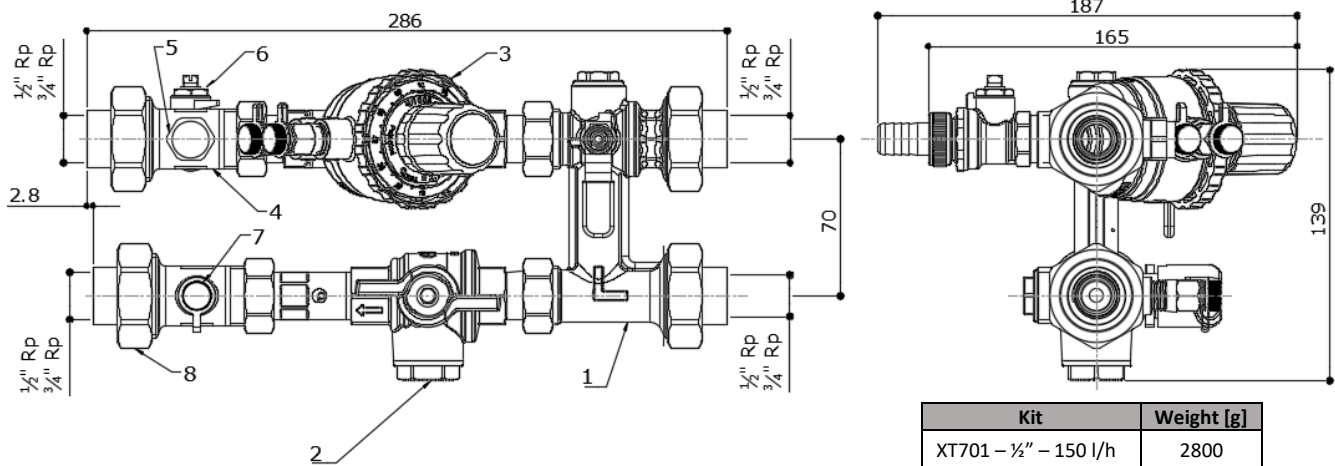

Dimensions in mm

Kit	Weight [g]
XT701 – ½” – 150 l/h	2800
XT701 – ½” – 600 l/h	2800
XT701 – ½” – 780 l/h	2800
XT701 - ¾” – 1000 l/h	2900
XT701 - ¾” – 1500 l/h	2900

MATERIAL LIST

#	Part number	QTY	Material
1	XT7BP	1	CuZn36Pb2As CW602N NDA
2	52F ½” or ¾”	1	CuZn36Pb2As CW602N NDA
3	91VL ½” – 150 l/h 91L ½” – 600 l/h 91H ½” – 780 l/h 91L ¾” – 1000 l/h 91H ¾” – 1500 l/h	1	CuZn36Pb2As CW602N NDA
4	1020P	2	CuZn40Pb2 CW617N
5	699C	1	CuZn39Pb3 CW614N
6	146ST	1	CuZn40Pb2 CW617N
7	T90	1	CuZn39Pb3 CW614N
8	B90CIL ½” or ¾”	4	CuZn40Pb2 CW617N

Please refers to dedicated technical specifications for further information and maintenance.

General XT technical submittal is also available for further information about XT range.

**ACCESSORIES (not included)**

- Soft thermal insulation with Velcro (multiple opening-closing), UL rated.
- Flexible hoses **FX series**
- Venturi fitting **CV90 series** for flow rate measurement (accuracy  $\pm 3\%$ )

**TECHNICAL FEATURES**

Centre to centre [mm]	Connections	Flow range		PICV min $\Delta P$	Assembly min $\Delta P$	Kv by-pass	Filtering capacity
		Min [l/h]	Max [l/h]	[kPa]	[kPa]		$\mu m$
70	1/2" F x 1/2" F unions	15	150	20	25	2.6	700
		60	600	25	35		
		78	780	35	35		
	3/4" F x 3/4" F unions	100	1000	30	45		
		450	1500	35	50		

**DATA**

Feature	
Pressure rating	PN25 (PN16 with flexible hoses)
Flow rate range	15 – 1500 l/h dependent on valve selection
Working temperature range <sup>^</sup>	-10 - +100° C
Working differential pressure range	25 – 600kPa minimum depends on valve and setting
Flow control accuracy (hysteresis)	$\pm 5\%$ till 1 bar DP, $\pm 10\%$ over 1 bar DP at 100% flow
Control valve characteristic	Equal Percentage
Control valve leakage rate to IEC 60534-4	Class IV
Thread types	BSP
Medium	Water or Water-Glycol 30%

<sup>^</sup>No frost and no steam. Under 0°C, glycol must be added. See temperature limits of flexible hoses and actuators (dedicated technical specifications). Water quality must comply requirements mentioned in PICV technical specification.

**SCHEMATIC**

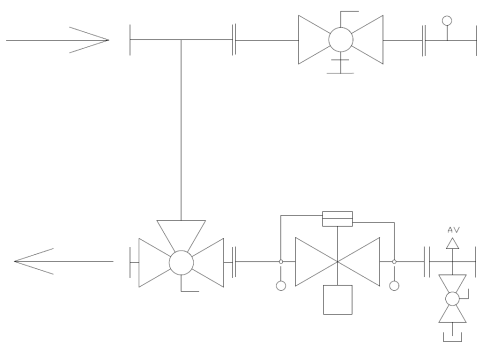

**OPERATIONS**

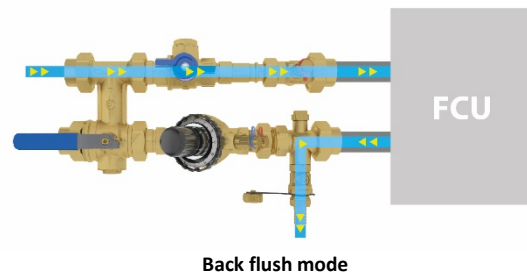
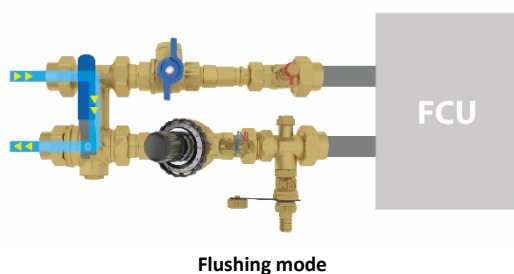

STIE00432 rev.01 - 08/09/2021

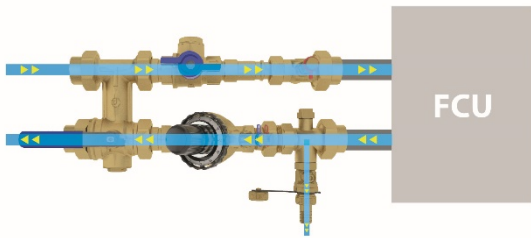

Filling and purging

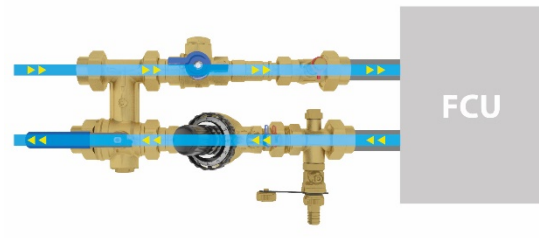

Operating mode

Pictures shown are for illustration only. They show operating modes of a similar kit.

ACTUATORS

Type	Part number	Stroke	Adaptor
24 V, 0-10 V prop., feedback	VA7483	6.3 mm*	0A7010
24 V, 0-10 V prop., feedback, fail safe	VA7484	6.3 mm*	0A7010
24 V, 0-10 V prop., feedback	VM000	6.5 mm*	76TE (included)
24 V, 0-10 V prop., feedback, fail safe	VM060	6.5 mm*	76TE (included)
24 V, 3 Point Floating	VA7481	6.3 mm	0A7010
230 V, 3 Point Floating	VA7481	6.3 mm	0A7010
24 V, 0-10 V Proportional Thermic	A544P3	4 mm	VA64 (included)
24 V, ON-OFF PWM Thermic	A544O2 or A544O4	4 mm	VA64 (included)
230 V, ON-OFF PWM Thermic	A542O2 or A542O4	4 mm	VA64 (included)



VA7481, VA7483 and VA7484



A54 series



VM series

\*Stroke detection system

INSTALLATION

The PICV can be installed in any position between vertical and horizontal for electrical safety reasons in case an actuator is mounted onto the valve. Upside down installation of the PICV must be avoided for electrical safety reasons.

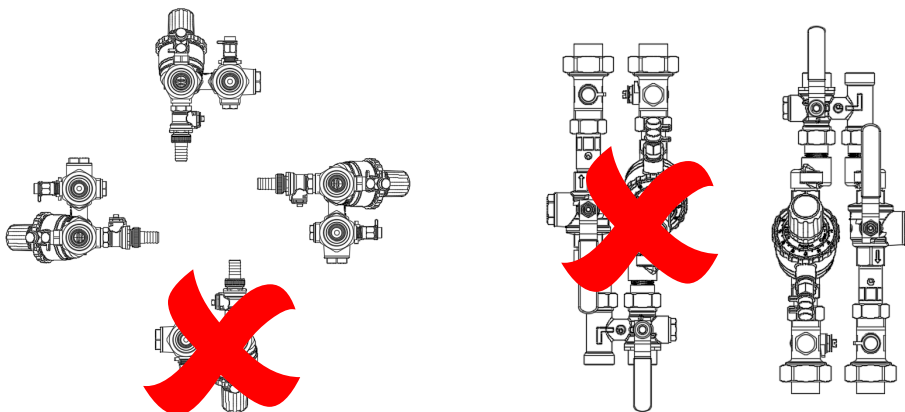

Pictures shown are for illustration only.