



REGULACIÓN CAUDAL COSTANTE

SERIES RPM-K - RPMC-K - RDR

Los reguladores de caudal de aire con flujo constante (CAV) están diseñados para regular el suministro o la salida de aire en los sistemas de ventilación.

Pueden instalarse en posición horizontal, vertical o inclinada.

Para garantizar un buen funcionamiento, el regulador (CAV) debe instalarse con la posición horizontal de su eje de las aspas. Las fuerzas aerodinámicas que actúan sobre la pala del regulador debido al flujo se equilibran por el dispositivo de control, que se ajusta en función del caudal requerido.

REGULACIÓN CAUDAL COSTANTE

SERIES RPM-K -
RPMC-K - RDR -
ALIZE AUTO

RPM-K	Regulador de caudal de aire, con flujo constante. Circular
RPC-K	Regulador de caudal de aire, con flujo constante. Cuadrado
RDR	Regulador de caudal de aire



RPM-K



RPC-K



RDR

SERIE

RPM-K



COMPUERTA CAUDAL CONSTANTE

Modelo **RPM-K**. Los reguladores de caudal de aire con flujo constante (CAV) están diseñados para regular el suministro o la salida de aire en los sistemas de ventilación. Pueden instalarse en posición horizontal, vertical o inclinada. Para garantizar un buen funcionamiento, el regulador (CAV) debe instalarse con la posición horizontal de su eje de las aspas. Las fuerzas aerodinámicas que actúan sobre la pala del regulador debido al flujo se equilibran por el dispositivo de control, que se ajusta en función del caudal requerido.

El ajuste del caudal requerido se realiza simplemente mediante una palanca con puntero y escala. Los reguladores mecánicos no necesitan estar conectados a ninguna fuente de energía externa.

El regulador se compone de la caja del regulador con una pala de control y el dispositivo de control.

El dispositivo de control se coloca dentro de la caja con la escala para el ajuste del flujo requerido. La precisión de la escala es de $\pm 5\%$.

Características:

- Tamaño nominal DN 80 a DN 400
- Longitud L = 450
- Espesor según EN 1751 Clase de estanqueidad externa de la carcasa C
- Volumen de flujo de aire 50 a 4 500 m³/h
- Precisión $\pm 15\text{-}20\%$ para velocidades de aire inferiores a 4m/s
- $\pm 10\%$ para velocidades de aire superiores a 4m/s
- Contaminación, deformación del cuerpo de la compuerta o circulación de aire no constante en toda la sección transversal de la compuerta puede traer mayor inexactitud.

Condiciones de trabajo:

- El funcionamiento impecable de los reguladores está garantizado en las siguientes condiciones:
 - a) velocidad máxima del flujo de aire 10 m/s b) presión máxima en el conducto 1000 Pa
 - c) la circulación de aire en toda la sección del controlador debe estar asegurada como constante en toda la superficie
- Los reguladores están diseñados para zonas macroclimáticas con clima suave según la norma EN 60 721-3-3.
- Los reguladores son adecuados para sistemas sin partículas abrasivas, químicas y adhesivas. La temperatura en el lugar de instalación puede oscilar entre 0°C y + 50°C.

Dimensiones:

ø80 a ø400

Modelos:

RPM-K.01
RPM-K.45
RPM-K.46
RPM-K.55
RPM-K.56
RPM-K.57

* ver descripción de modelos en tabla

*

Modelos:

- RPM-K.01** Accionamiento manual
- RPM-K.45** Mecanismo de accionamiento 230V, control de apertura y cierre
- RPM-K.46** Mecanismo de accionamiento 230V, control de apertura y cierre, con contacto final de carrera
- RPM-K.55** Mecanismo de accionamiento 24V, control de apertura y cierre
- RPM-K.56** Mecanismo de accionamiento 24V, control de apertura y cierre, con contacto final de carrera
- RPM-K.57** Mecanismo de accionamiento 24V SR, control proporcional

SERIE RPM-K



RPM-K.01

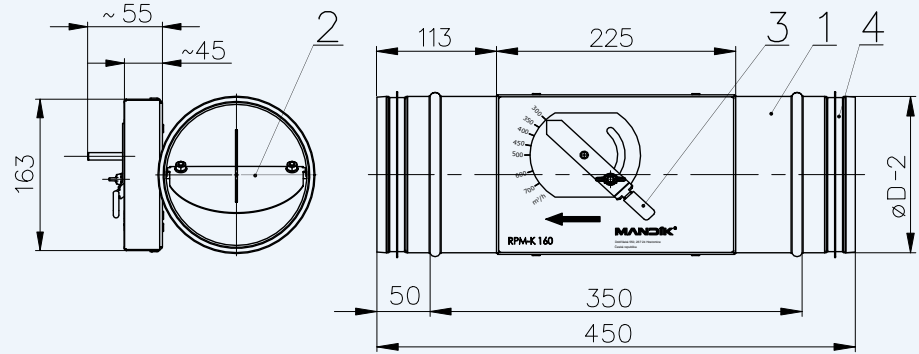

1. Tapa del regulador
2. Hoja del regulador
3. Palanca
4. Junta de goma
5. Mecanismo de accionamiento

RPM-K.45 / .55

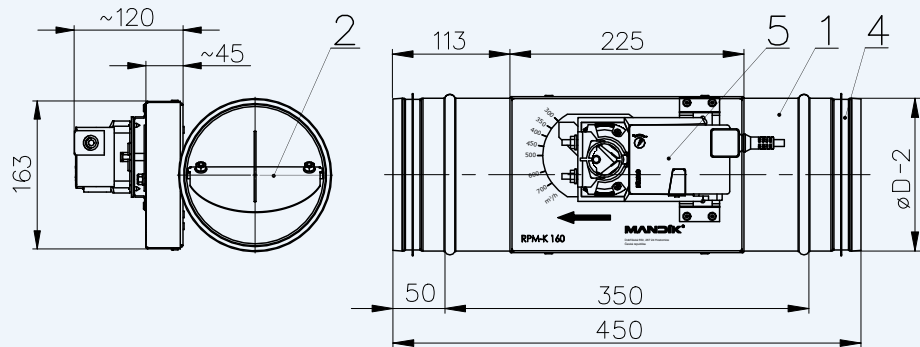

1. Tapa del regulador
2. Hoja del regulador
3. Palanca
4. Junta de goma
5. Mecanismo de accionamiento

RPM-K

Distancia recomendada con respecto a la unión de la rama doble

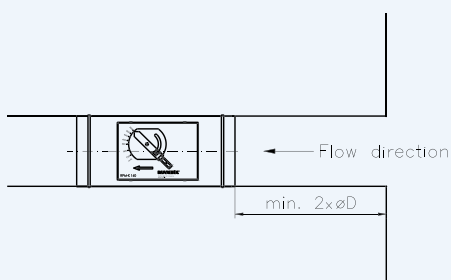

RPM-K

Distancia recomendada de la curva

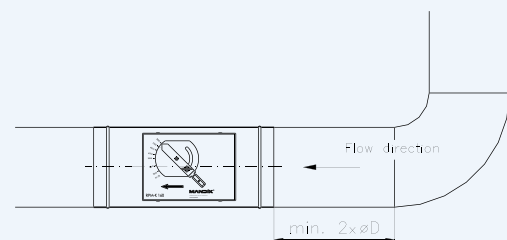

SERIE

RPM-K

DATOS TÉCNICOS



Pérdida de presión

Pérdidas de presión (los valores son válidos cuando la compuerta del regulador está completamente abierta).

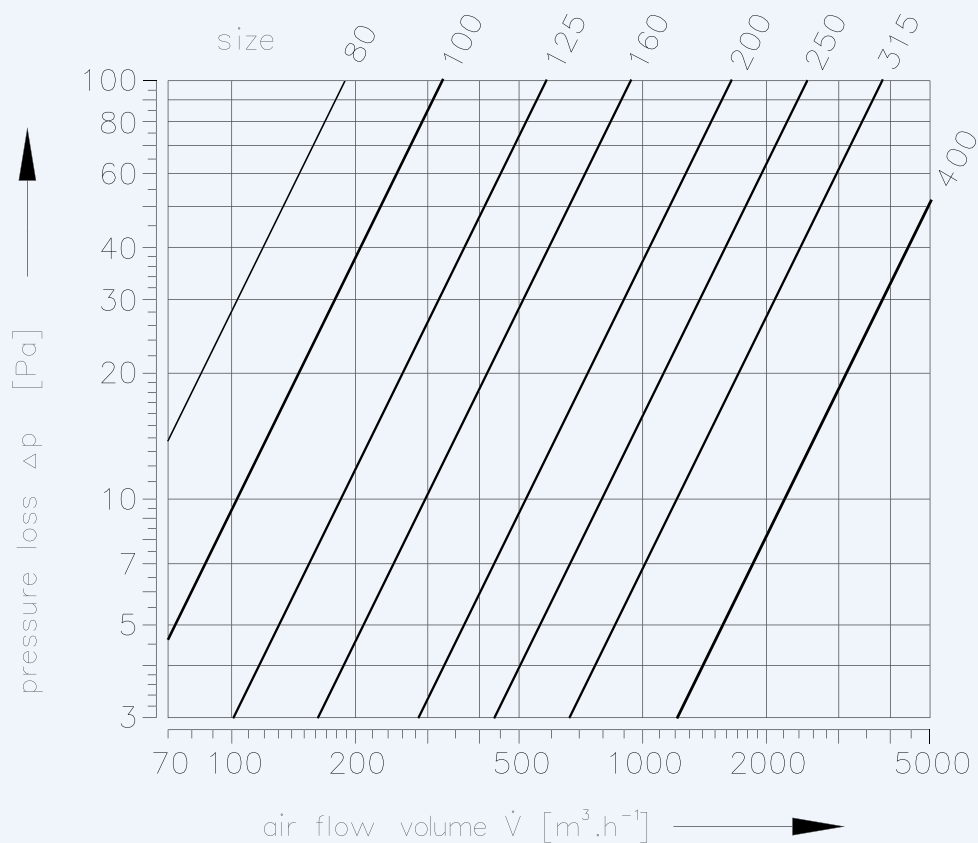

Información de ruido

Ruido regenerado por el aire

El ruido producido por el flujo del regulador de volumen de aire se indica en las siguientes tablas.

V [$\text{m}^3 \cdot \text{h}^{-1}$] - volumen de flujo de aire

Δp [Pa] - presión diferencial

L_w [dB/Okt.] - nivel de potencia acústica en la banda de octava

L_{WA} [dB(A)] - nivel total de potencia acústica

corregido por el filtro A

f_m [Hz] - frecuencias medias en las bandas de octava

SERIE

RPM-K

DATOS TÉCNICOS



Nivel de potencia sonora en el interior de la tubería con una diferencia de presión de 50 Pa

$\Delta P_{st} = 50 \text{ Pa}$										
Dimensión [mm]	V [m³/h]	L_w [dB/Okt]								L_{WA} [dB(A)]
		f_m [Hz]								
		63	125	250	500	1000	2000	4000	8000	
80	50	48	38	32	32	35	31	23	<15	38
	100	54	45	41	38	39	34	28	18	43
	150	60	52	48	44	43	39	35	23	48
	200	66	58	54	49	46	42	39	28	52
100	80	49	39	33	33	36	32	24	<15	39
	155	56	47	43	40	41	37	30	20	45
	225	62	54	50	46	45	41	37	26	50
	300	67	59	56	51	48	44	41	30	54
125	125	50	40	34	34	37	33	26	<15	40
	250	58	49	46	43	44	40	33	22	47
	380	64	56	52	48	47	44	40	28	52
	500	70	62	58	53	50	46	43	32	56
160	200	54	44	38	38	41	37	29	18	44
	430	59	50	46	45	44	40	34	23	48
	650	65	57	53	49	48	44	40	28	53
	900	68	61	57	52	49	45	42	31	55
200	300	53	43	37	37	40	36	29	17	43
	630	60	51	47	44	45	41	35	24	49
	960	66	58	54	50	49	45	41	29	54
	1300	72	64	60	55	52	48	45	34	58
250	500	54	44	38	38	41	37	29	18	44
	1000	60	51	47	44	45	41	34	24	49
	1500	66	58	54	50	49	46	42	30	54
	2000	72	64	60	55	52	48	45	34	58
315	800	55	45	39	39	42	38	30	19	45
	1500	62	53	49	46	47	43	36	25	51
	2150	66	58	54	50	49	45	41	30	54
	2800	74	66	62	57	54	50	47	36	60
400	1200	38	28	22	22	25	21	<15	<15	28
	2300	41	32	28	25	26	22	15	<15	30
	3400	44	36	32	28	27	23	19	<15	32
	4500	47	39	35	30	27	23	20	<15	33

SERIE

RPM-K

DATOS TÉCNICOS



Nivel de potencia sonora en el interior de la tubería con una diferencia de presión de 100 Pa

$\Delta P_{st} = 100 \text{ Pa}$

Dimensión [mm]	V [m³/h]	L_w [dB/Okt]								L_{WA} [dB(A)]
		f_m [Hz]								
		63	125	250	500	1000	2000	4000	8000	
80	50	52	42	36	36	39	35	27	15	42
	100	58	49	45	42	43	39	32	21	47
	150	64	56	52	48	47	43	39	27	52
	200	70	62	58	53	50	46	43	32	56
100	80	53	43	37	37	40	36	28	16	43
	155	60	51	47	44	45	41	34	23	49
	225	66	58	54	50	49	45	41	29	54
	300	72	64	60	55	52	48	45	34	58
125	125	55	45	39	39	42	38	30	18	45
	250	63	54	50	47	48	44	37	26	52
	380	69	61	57	53	52	48	44	32	57
	500	74	66	62	57	55	50	47	36	61
160	200	58	48	42	42	45	41	33	21	48
	430	64	55	51	48	49	45	38	27	53
	650	69	61	57	53	52	48	44	32	57
	900	74	66	62	57	54	50	47	36	60
200	300	58	48	42	42	45	41	33	21	48
	630	65	56	52	49	50	46	39	28	54
	960	70	62	58	54	53	49	45	33	58
	1300	76	68	64	59	56	52	49	38	62
250	500	59	49	43	43	46	42	34	22	49
	1000	65	56	52	49	50	46	39	28	54
	1500	71	63	59	55	54	50	46	34	59
	2000	76	68	64	59	56	52	49	38	62
315	800	60	50	44	44	47	43	35	23	50
	1500	66	57	53	50	51	47	40	29	55
	2150	71	63	59	55	54	50	46	34	59
	2800	78	70	65	59	57	53	51	40	63
400	1200	67	58	54	51	52	48	41	30	56
	2300	70	62	58	54	55	51	45	33	59
	3400	73	65	60	57	58	53	49	36	62
	4500	76	68	64	60	59	55	51	39	64

SERIE

RPM-K

DATOS TÉCNICOS



Nivel de potencia sonora en el interior de la tubería con una diferencia de presión de 250 Pa

$\Delta P_{st} = 250 \text{ Pa}$										
Dimensión [mm]	V [m³/h]	L_w [dB/Okt]								L_{WA} [dB(A)]
		f_m [Hz]								
		63	125	250	500	1000	2000	4000	8000	
80	50	58	48	42	42	45	41	33	21	48
	100	64	55	51	48	49	45	38	27	53
	150	70	62	58	54	53	49	45	33	58
	200	76	68	64	59	56	52	49	38	62
100	80	59	49	43	43	46	42	34	22	49
	155	65	56	52	49	50	46	39	28	54
	225	73	65	61	56	55	52	48	36	60
	300	77	69	65	60	57	53	50	39	63
125	125	64	54	48	47	50	47	39	27	53
	250	69	60	56	53	54	50	43	32	58
	380	75	67	63	59	58	54	50	38	63
	500	81	73	69	64	61	58	55	44	67
160	200	66	56	50	50	53	49	41	29	56
	430	72	63	59	56	57	53	46	35	61
	650	77	69	65	61	60	56	52	40	65
	900	79	73	69	64	63	55	53	42	68
200	300	67	57	51	51	54	50	42	30	57
	630	72	63	59	56	57	53	46	35	61
	960	77	69	65	61	60	56	52	40	65
	1300	81	73	69	64	61	57	54	43	67
250	500	68	58	52	52	55	51	43	31	58
	1000	72	63	59	58	58	53	46	35	62
	1500	77	69	65	62	61	57	52	40	66
	2000	82	74	70	65	63	58	55	44	69
315	800	68	58	52	52	55	51	43	31	58
	1500	74	65	61	58	59	55	48	37	63
	2150	78	70	66	62	61	57	53	41	66
	2800	82	74	70	65	63	58	55	44	69
400	1200	73	64	58	58	60	57	50	37	64
	2300	75	67	63	61	62	58	50	38	66
	3400	77	69	66	63	65	59	51	41	68
	4500	81	74	70	66	65	61	56	44	70

SERIE RPM-K

DATOS TÉCNICOS



Nivel de potencia sonora en el interior de la tubería con una diferencia de presión de 500 Pa

$\Delta P_{st} = 500 \text{ Pa}$

Dimensión [mm]	V [m³/h]	L_w [dB/Okt]								L_{WA} [dB(A)]
		f_m [Hz]								
		63	125	250	500	1000	2000	4000	8000	
80	50	64	54	48	48	51	47	39	27	54
	100	70	61	57	54	55	51	44	33	59
	150	76	68	64	60	59	55	51	39	64
	200	82	74	70	65	62	58	55	44	68
100	80	65	55	49	49	52	48	40	28	55
	155	71	62	58	55	56	52	45	34	60
	225	78	70	66	62	61	57	53	41	66
	300	83	75	71	66	63	60	57	46	69
125	125	71	61	55	54	57	54	46	34	60
	250	76	67	63	60	61	57	50	39	65
	380	82	74	70	66	65	61	57	45	70
	500	87	79	75	70	67	63	60	49	73
160	200	72	62	56	56	59	55	47	35	62
	430	79	70	66	63	63	60	53	42	67
	650	83	75	71	67	66	62	58	46	71
	900	88	80	76	71	68	64	61	50	74
200	300	74	64	58	58	61	57	49	37	64
	630	79	70	66	63	64	60	53	42	68
	960	83	75	71	67	66	62	58	46	71
	1300	87	79	75	70	67	63	60	49	73
250	500	76	66	60	60	63	59	51	39	66
	1000	80	71	67	64	65	61	54	43	69
	1500	84	76	72	68	67	63	59	47	72
	2000	88	80	76	71	68	64	61	50	74
315	800	76	66	60	60	63	59	51	39	66
	1500	80	71	67	66	66	61	54	43	70
	2150	85	77	73	68	67	64	60	48	72
	2800	88	80	76	71	68	64	61	50	74
400	1200	79	70	65	66	68	62	53	42	71
	2300	83	74	70	68	69	65	58	47	73
	3400	86	76	73	70	71	66	59	48	75
	4500	88	81	77	73	72	68	64	51	77

SERIE RPM-K

DATOS TÉCNICOS



Nivel de potencia sonora L_{wa} (dB (A)) en el interior de la conducción

Ø 80

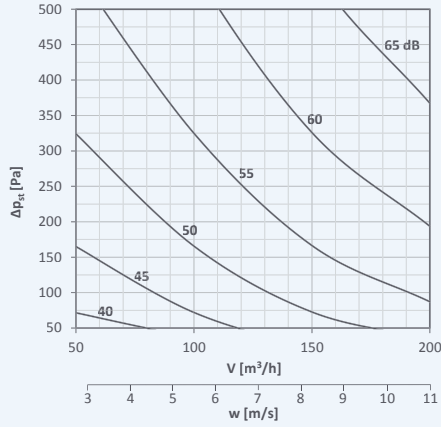

Ø 100

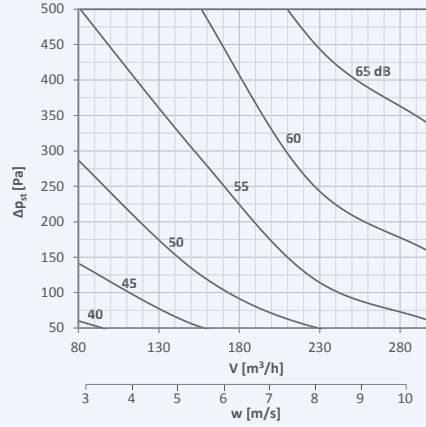

Ø 125

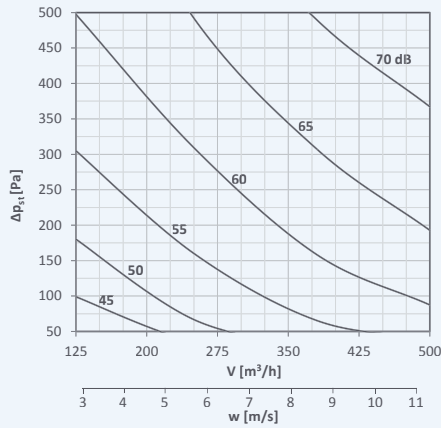

Ø 160

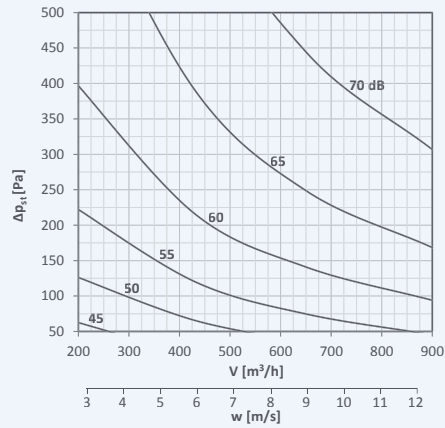

Ø 200

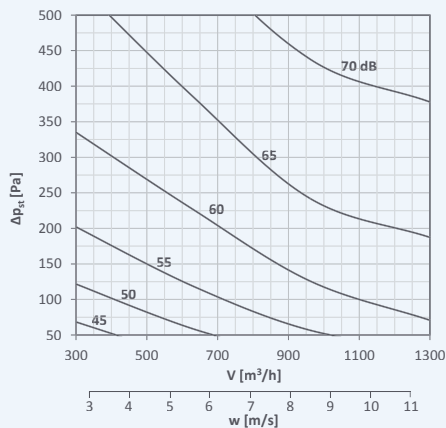

Ø 250

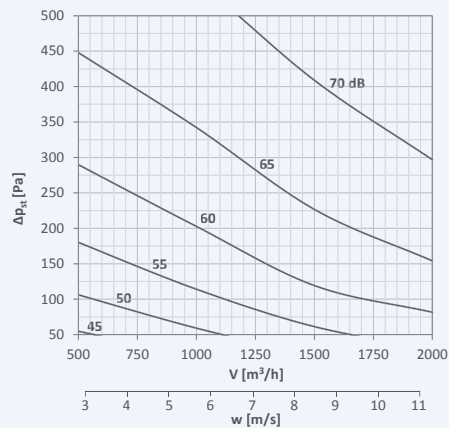

SERIE RPM-K

DATOS TÉCNICOS



REGULACIÓN

Nivel de potencia sonora L_{wa} (dB (A)) en el interior de la conducción

Ø 315

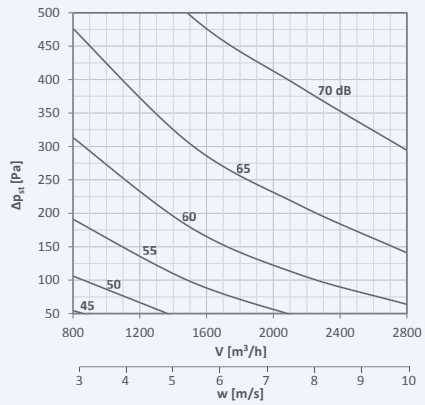

Ø 400

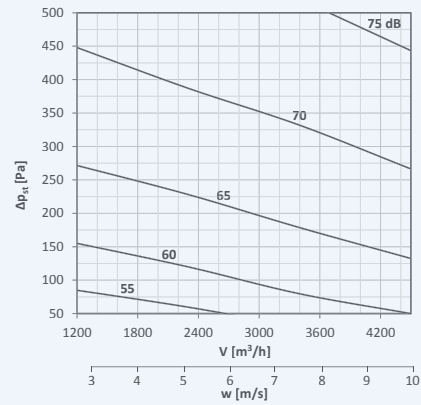

SERIE

RPM-K

DATOS TÉCNICOS



Nivel de potencia acústica radiada en el exterior de la tubería - sin aislamiento

El ruido radiado del controlador de volumen de aire se indica a continuación

Ruido radiado

V [m³h⁻¹] - volumen de flujo de aire
 ΔP_{st} [Pa] - presión diferencial

L_{WA} [dB(A)] - nivel total de potencia acústica
 corregido por el filtro A

Dimensión [mm]	V [m ³ /h]	L _{WA} [dB(A)]	L _{WA} [dB(A)]	L _{WA} [dB(A)]	L _{WA} [dB(A)]
		$\Delta P_{st}= 50$ Pa	$\Delta P_{st}= 100$ Pa	$\Delta P_{st}= 250$ Pa	$\Delta P_{st}= 500$ Pa
80	100	<15	<15	<15	<15
	150	<15	<15	15	20
	200	<15	<15	17	22
100	80	<15	<15	<15	<15
	155	<15	<15	<15	15
	225	<15	<15	19	22
	300	<15	<15	20	25
125	125	<15	<15	<15	15
	250	<15	<15	15	20
	380	<15	17	24	28
	500	18	21	28	30
160	200	<15	<15	19	22
	430	<15	18	26	30
	650	20	23	32	35
	900	21	25	31	37
200	300	<15	15	20	22
	630	16	19	25	30
	960	22	26	34	38
	1300	25	29	36	40
250	500	<15	15	23	27
	1000	16	20	28	33
	1500	24	28	36	42
	2000	27	31	39	44
315	800	<15	16	22	27
	1500	18	22	28	34
	2150	25	29	35	41
	2800	29	33	38	45
400	1200	19	22	28	32
	2300	24	27	33	37
	3400	30	33	39	43
	4500	33	36	42	46

SERIE RPM-K

DATOS TÉCNICOS



Nivel de potencia sonora L_{wa} (dB (A)) en el interior de la conducción - sin aislamiento

Ø 80

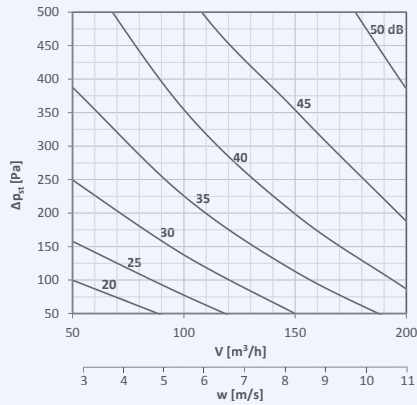

Ø 100

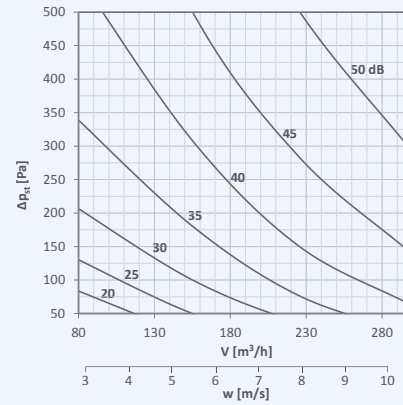

Ø 125

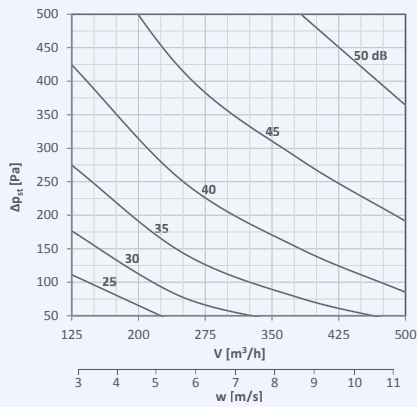

Ø 160

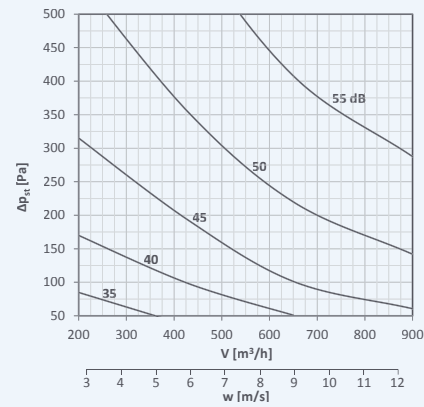

Ø 200

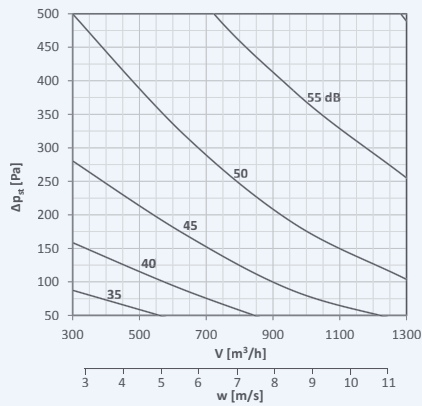

Ø 250

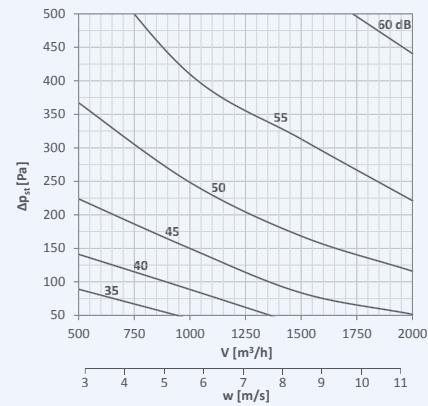

SERIE RPM-K

DATOS TÉCNICOS



Nivel de potencia sonora L_{wa} (dB (A)) en el interior de la conducción - sin aislamiento

Ø 315

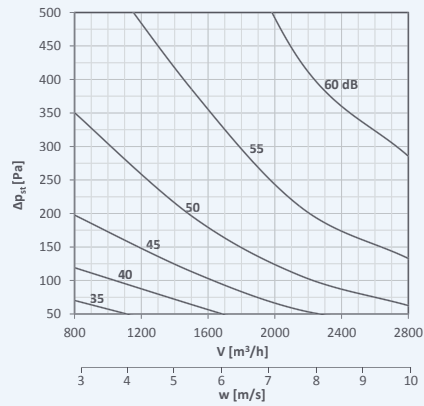

Ø 400

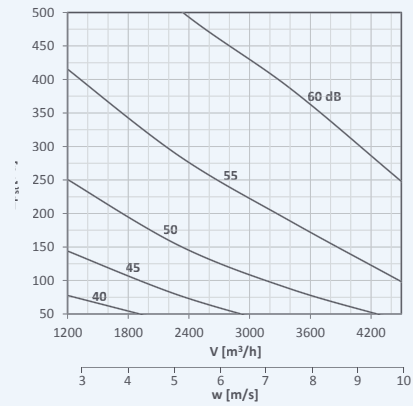

SERIE RPMC-K



COMPUERTA CAUDAL CONSTANTE

Modelo **RPMC-K**. Los reguladores de caudal constantes están pensados para sistemas de entrada o salida de aire. Los reguladores pueden instalarse en posición horizontal o vertical con el eje de las palas horizontal. Las fuerzas aerodinámicas que actúan sobre la lista debido al flujo son compensadas por el dispositivo de control ajustado según el caudal requerido. Los controladores mecánicos no necesitan estar conectados a ninguna fuente de alimentación externa. El ajuste del caudal requerido se realiza simplemente mediante una palanca con puntero y escala.

El controlador consiste en la caja del controlador con una hoja de control y un dispositivo de control.

El dispositivo de control se coloca dentro de la caja con la escala para el ajuste del flujo requerido. La precisión de la escala es de $\pm 5\%$

Características:

- Tamaño nominal 200x100 a 600x600
- Longitud $L = 350$
- Espesor según EN 1751 Clase de estanqueidad externa de la carcasa C
- Volumen de flujo de aire 250 a 12 000 m³/h
- Precisión 10% -15% (en las posiciones mín./máx. 20%)

Condiciones de trabajo:

- El funcionamiento correcto de los reguladores está garantizado en las siguientes condiciones:
 - a) velocidad máxima del flujo de aire 10m/s
 - b) presión máxima en el conducto 1000 Pa
 - c) la circulación de aire en toda la sección del controlador debe estar asegurada como constante en toda la superficie
- Los reguladores están diseñados para zonas macroclimáticas con clima suave según la norma EN 60 721-3-3.
- Los reguladores son adecuados para sistemas sin partículas abrasivas, químicas y adhesivas. La temperatura en el lugar de instalación puede oscilar entre 0°C y + 50°C.

Dimensiones:

200X100 a 600x600

Modelos:

RPMC-K.01
RPMC-K.45
RPMC-K.46
RPMC-K.55
RPMC-K.56
RPMC-K.57

* ver descripción de modelos en tabla

*

Modelos:

- RPMC-K.01** Accionamiento manual
- RPMC-K.45** Mecanismo de accionamiento 230V, control de apertura y cierre
- RPMC-K.46** Mecanismo de accionamiento 230V, control de apertura y cierre, con contacto final de carrera
- RPMC-K.55** Mecanismo de accionamiento 24V, control de apertura y cierre
- RPMC-K.56** Mecanismo de accionamiento 24V, control de apertura y cierre, con contacto final de carrera
- RPMC-K.57** Mecanismo de accionamiento 24V SR, control proporcional

SERIE

RPMC-K



RPMC-K.01

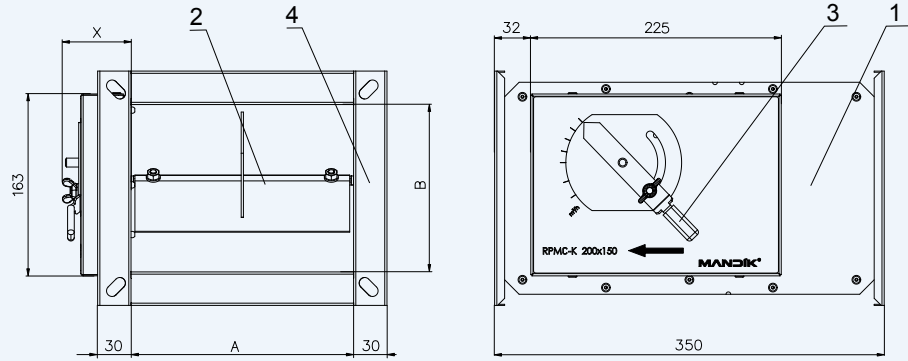

1. Tapa del regulador
2. Hoja del regulador
3. Palanca
4. Pestaña
5. Mecanismo de accionamiento

RPMC-K.45 / .55

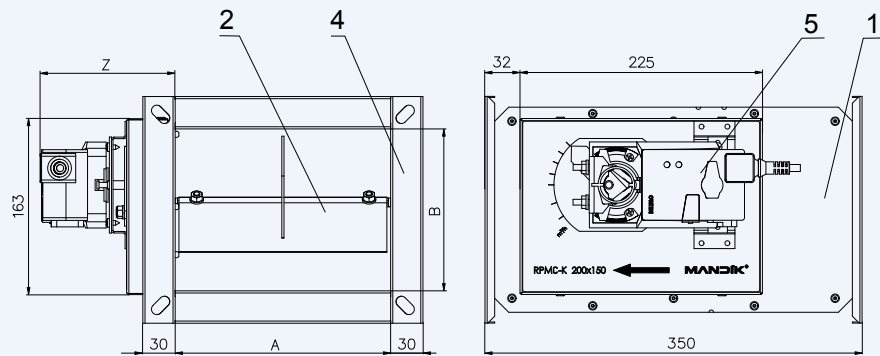

1. Tapa del regulador
2. Hoja del regulador
3. Palanca
4. Pestaña
5. Mecanismo de accionamiento

RPMC-K

Distancia recomendada con respecto a la unión de la rama doble

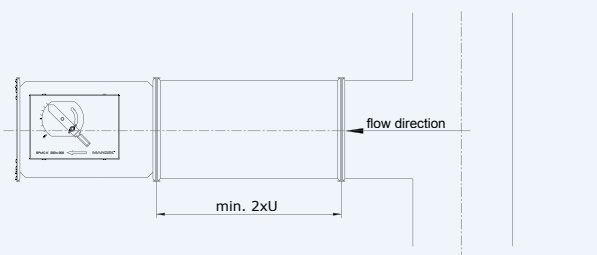

*U = diagonal

RPMC-K

Distancia recomendada de la curva

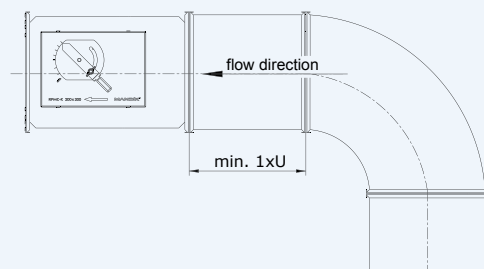

SERIE

RPMC-K

DATOS TÉCNICOS



Cálculo de pérdida de presión

$$\Delta p = \xi \cdot \rho \cdot \frac{w^2}{2}$$

Δp [Pa] pérdida de presión
 w [m.s⁻¹] velocidad del flujo de aire en la sección nominal del controlador
 ρ [kg.m⁻³] densidad del aire
 ξ [-] Coeficiente de pérdida de presión local para la sección nominal del regulador (ver Tab. 7.1.1.)

Coeficiente de pérdida de presión local (los valores son válidos cuando la compuerta del regulador

Dimensiones AxB [mm]	ξ	Dimensiones AxB [mm]	ξ	Dimensiones AxB [mm]	ξ
200x100	1.386	400x200	1.344	500x500	1.224
200x150	1.379	400x250	1.330	600x200	1.316
200x200	1.372	400x300	1.316	600x250	1.295
300x100	1.379	400x400	1.288	600x300	1.274
300x150	1.368	500x200	1.330	600x400	1.231
300x200	1.358	500x250	1.312	600x500	1.189
300x250	1.347	500x300	1.295	600x600	1.147
300x300	1.337	500x400	1.260		

Pérdidas de presión (los valores son válidos cuando la compuerta del regulador está completamente abierta)

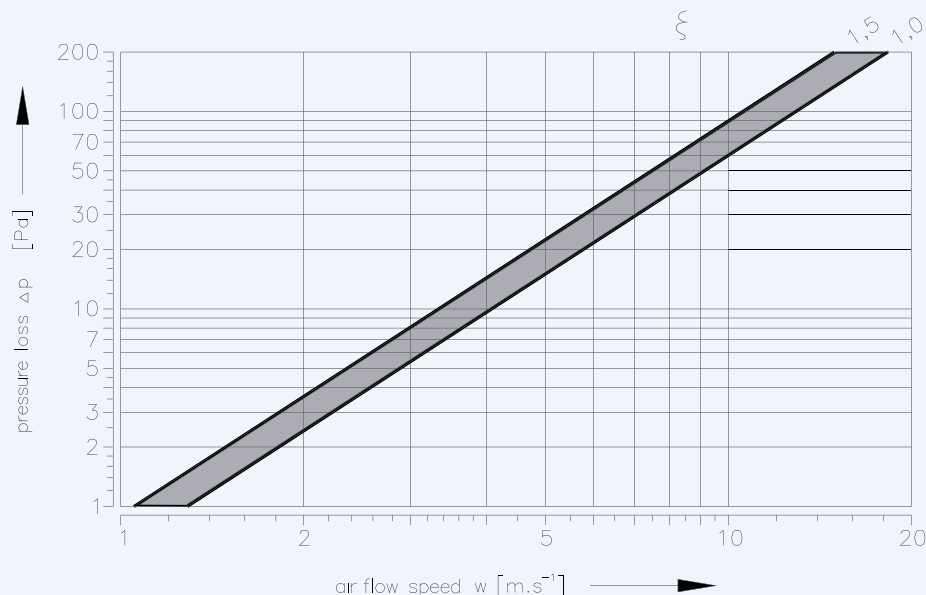

Información de ruido

El ruido producido por el flujo del regulador de volumen de aire se indica en las siguientes tablas.

Ruido regenerado por el aire

V [m³h⁻¹] - volumen de flujo de aire

Δst [Pa] - presión diferencial

L_w [dB/Okt.] - nivel de potencia acústica en la banda de octava

L_{WA} [dB(A)] - nivel total de potencia acústica corregido por el filtro A

f_m [Hz] - frecuencias medias en las bandas de octava

SERIE

RPMC-K

DATOS TÉCNICOS



Nivel de potencia sonora en el interior de la tubería con una diferencia de presión de 50 Pa

Dimensión [mm]	V [m³/h]	$\Delta P_{st} = 50 \text{ Pa}$								$L_{WA} \text{ [dB(A)]}$
		$L_w \text{ [dB(0kt)]}$								
		$f_m \text{ [Hz]}$								
		63	125	250	500	1000	2000	4000	8000	
200x100	250	39	38	34	34	35	36	35	33	42
	400	44	43	41	40	39	41	41	38	47
	550	43	45	44	43	45	43	44	40	50
	700	47	46	47	47	48	46	47	41	53
200x150	400	42	41	37	37	37	38	38	35	44
	600	44	43	42	43	42	42	42	39	49
	800	45	46	45	45	46	45	46	43	52
	1000	49	49	48	48	49	48	48	44	55
200x200	500	42	41	37	37	37	38	38	35	44
	765	45	44	42	41	40	42	42	39	48
	1035	44	46	47	46	46	44	44	38	51
	1300	47	46	47	48	48	47	47	39	54
300x100	400	45	44	40	40	40	41	41	38	47
	600	48	47	45	44	43	45	45	42	51
	800	48	50	51	50	50	48	48	42	55
	1000	51	50	51	52	52	51	51	43	58
300x150	500	42	41	37	37	37	38	38	35	44
	835	46	45	43	42	41	43	43	40	49
	1165	47	49	50	49	49	47	47	41	54
	1500	51	50	51	52	52	51	51	43	58
300x200	600	44	43	39	39	39	40	40	37	46
	1065	47	46	44	43	42	44	44	41	50
	1535	47	49	50	49	49	47	47	41	54
	2000	52	51	52	53	53	52	52	44	59
300x250	800	45	44	40	40	40	41	41	38	47
	1365	49	47	45	44	43	45	45	42	51
	1935	48	50	51	50	50	48	48	42	55
	2500	51	50	51	52	52	51	51	43	58
300x300	1000	45	44	40	40	40	41	41	38	47
	4665	48	47	45	44	43	45	45	42	51
	2335	48	50	51	50	50	48	48	42	55
	3000	51	50	51	52	52	51	51	43	58
400x200	900	45	44	40	40	40	41	41	38	47
	1500	47	46	44	44	42	44	44	41	50
	2100	47	49	50	49	49	47	47	41	54
	2700	50	49	50	51	51	50	50	42	57
400x250	1200	46	45	41	41	40	42	42	39	48
	1935	48	47	45	44	43	45	45	42	51
	2665	47	49	50	49	49	47	47	41	54
	3400	50	49	50	51	51	50	50	42	57
400x300	1500	47	46	42	42	41	43	43	40	49
	2400	49	48	46	45	44	46	46	43	52
	3300	49	51	52	51	51	49	49	43	56
	4200	53	52	53	54	54	53	53	45	60
400x400	1800	48	48	44	44	43	45	45	42	51
	3000	51	50	48	47	46	48	48	45	54
	4200	50	52	53	52	52	50	50	44	57
	4500	82	74	70	65	62	58	55	44	68

SERIE

RPMC-K

DATOS TÉCNICOS



Nivel de potencia sonora en el interior de la tubería con una diferencia de presión de 50 Pa

$\Delta P_{st} = 50 \text{ Pa}$										
Dimensión [mm]	V [m³/h]	L_w [dB/Okt]								L_{WA} [dB(A)]
		f_m [Hz]								
		63	125	250	500	1000	2000	4000	8000	
500x200	1100	43	42	38	38	37	39	39	36	45
	1865	45	43	42	41	39	42	42	39	48
	2635	44	46	47	46	46	44	44	38	51
	3400	48	47	48	49	49	48	48	40	55
500x250	1500	45	44	40	40	39	41	41	38	47
	2400	48	47	45	44	42	45	45	42	51
	3300	47	49	50	49	49	47	47	41	54
	4200	49	48	49	50	50	49	49	41	56
500x300	1800	46	45	41	41	40	42	42	39	48
	2800	48	47	45	44	42	45	45	42	51
	3800	48	50	51	50	50	48	48	42	55
	4800	51	50	51	52	52	51	51	43	58
500x400	2200	51	50	46	46	45	47	47	44	53
	3735	54	53	51	50	47	51	51	48	57
	5265	53	55	56	55	55	53	53	47	60
	6800	56	55	56	57	57	56	56	48	63
500x500	3000	53	52	48	48	48	49	49	46	55
	4800	56	55	53	52	49	53	53	50	59
	6600	55	57	58	57	57	55	55	49	62
	8400	58	57	58	59	59	58	58	50	65
600x200	1500	43	42	39	39	39	40	40	37	46
	2335	47	45	43	42	40	43	43	40	49
	3165	46	48	49	48	48	46	46	40	53
	4000	49	48	49	50	50	49	49	41	56
600x250	1800	45	45	41	41	41	42	42	39	48
	2865	48	47	45	44	42	45	45	42	51
	3935	47	49	50	49	49	47	47	41	54
	5000	50	49	50	51	51	50	50	42	57
600x300	2100	48	47	43	43	43	44	44	41	50
	3400	49	48	46	45	44	46	46	43	52
	4700	48	50	51	50	50	48	48	42	55
	6000	51	50	51	52	52	51	51	43	58
600x400	3000	51	50	46	46	46	47	47	44	53
	4665	53	52	50	49	48	50	50	47	56
	6335	53	55	56	55	55	53	53	47	60
	8000	55	54	55	56	56	55	55	47	62
600x500	3600	53	52	48	48	48	49	49	46	55
	5735	56	55	53	52	51	53	53	50	59
	7865	55	57	58	57	57	55	55	49	62
	10000	58	57	58	59	59	58	58	50	65
600x600	4200	56	55	51	51	51	52	52	49	58
	6800	58	57	55	54	53	55	55	52	61
	9400	57	59	60	59	59	57	57	51	64
	12000	59	58	59	60	60	59	59	51	66

SERIE

RPMC-K

DATOS TÉCNICOS



Nivel de potencia sonora en el interior de la tubería con una diferencia de presión de 100 Pa

Dimensión [mm]	V [m³/h]	$\Delta P_{st} = 100 \text{ Pa}$								$L_{WA} \text{ [dB(A)]}$
		$L_w \text{ [dB/OkT]}$								
		$f_m \text{ [Hz]}$								
		63	125	250	500	1000	2000	4000	8000	
200x100	250	46	45	41	41	41	42	42	39	48
	400	49	48	46	45	44	46	46	43	52
	550	50	50	51	50	50	48	48	43	55
	700	52	51	53	52	52	51	51	45	58
200x150	400	46	45	42	42	42	43	43	39	49
	600	50	49	47	46	45	47	46	43	53
	800	51	51	52	51	51	49	49	43	56
	1000	52	51	52	53	53	52	52	44	59
200x200	500	48	47	43	43	43	44	44	41	50
	765	50	49	47	46	45	47	47	44	53
	1035	49	51	52	51	51	49	49	43	56
	1300	52	51	52	53	53	52	52	44	59
300x100	400	49	48	44	44	44	45	45	42	51
	600	51	50	48	47	46	48	48	45	54
	800	51	53	54	53	53	51	51	45	58
	1000	54	53	54	55	55	54	54	46	61
300x150	500	47	46	42	42	42	43	43	40	49
	835	51	50	48	47	46	48	48	45	54
	1165	52	54	55	54	54	52	52	46	59
	1500	57	55	56	57	57	56	56	48	63
300x200	600	50	49	45	45	45	46	46	43	52
	1065	53	52	50	49	48	50	50	47	56
	1535	53	55	56	55	55	53	53	47	60
	2000	57	56	57	58	58	57	57	49	64
300x250	800	51	50	46	46	46	47	47	44	53
	1365	55	53	51	50	49	51	51	48	57
	1935	53	55	56	55	55	53	53	47	60
	2500	56	55	56	57	57	56	56	48	63
300x300	1000	51	50	46	46	46	47	47	44	53
	4665	54	53	51	50	49	51	51	48	57
	2335	54	55	56	55	55	53	53	47	60
	3000	56	55	56	57	57	56	56	48	63
400x200	900	51	50	46	46	46	47	47	44	53
	1500	53	52	50	49	48	50	50	47	56
	2100	52	54	55	54	54	52	52	46	59
	2700	55	54	55	56	56	55	55	47	62
400x250	1200	52	51	47	47	47	48	48	45	54
	1935	54	53	51	50	49	51	51	48	57
	2665	53	55	56	55	55	53	53	47	60
	3400	55	54	55	56	56	55	55	47	62
400x300	1500	53	52	48	48	48	49	49	46	55
	2400	55	54	52	51	50	52	52	49	58
	3300	55	57	58	57	57	55	55	49	62
	4200	59	58	59	60	60	59	59	51	66
400x400	1800	55	54	50	50	50	51	51	48	57
	3000	57	56	54	53	52	54	54	51	60
	4200	56	58	59	58	58	56	56	50	63
	5400	60	59	60	61	61	60	60	52	67

SERIE RPMC-K

DATOS TÉCNICOS



Nivel de potencia sonora en el interior de la tubería con una diferencia de presión de 100 Pa

$\Delta P_{st} = 100 \text{ Pa}$										
Dimensión [mm]	V [m³/h]	L_w [dB/Okt]								L_{WA} [dB(A)]
		f_m [Hz]								
		63	125	250	500	1000	2000	4000	8000	
500x200	1100	49	48	44	44	44	45	45	42	51
	1865	51	50	48	47	46	48	48	45	54
	2635	50	52	53	52	52	50	50	44	57
	3400	53	52	53	54	54	53	53	45	60
500x250	1500	51	50	46	46	46	47	47	44	53
	2400	53	52	50	49	48	50	50	47	56
	3300	52	54	55	54	54	52	52	46	59
	4200	54	53	54	55	55	54	54	46	61
500x300	1800	52	51	47	47	47	48	48	45	54
	2800	54	53	51	50	49	51	51	48	57
	3800	53	55	56	55	55	53	53	47	60
	4800	56	55	56	57	57	56	56	48	63
500x400	2200	56	55	51	51	51	52	52	49	58
	3735	59	58	56	55	54	56	56	53	62
	5265	58	60	61	60	60	58	58	52	65
	6800	61	60	61	62	62	61	61	53	68
500x500	3000	58	57	53	53	53	54	54	51	60
	4800	61	60	58	57	56	58	58	55	64
	6600	60	62	63	62	62	60	60	54	67
	8400	62	61	62	63	63	62	62	54	69
600x200	1500	50	49	45	45	45	46	46	43	52
	2335	53	51	49	48	47	49	49	46	55
	3165	51	53	54	53	53	51	51	45	58
	4000	54	53	54	55	55	54	54	46	61
600x250	1800	52	51	47	47	47	48	48	45	54
	2865	54	53	51	50	49	51	51	48	57
	3935	54	55	56	55	55	53	53	47	60
	5000	57	55	56	57	57	56	56	48	63
600x300	2100	53	52	48	48	48	49	49	46	55
	3400	55	54	52	51	50	52	52	49	58
	4700	54	56	57	56	56	54	54	48	61
	6000	56	55	56	57	57	56	56	48	63
600x400	3000	57	56	52	52	52	53	53	50	59
	4665	59	58	56	55	54	56	56	53	62
	6335	58	60	61	60	60	58	58	52	65
	8000	60	59	60	61	61	60	60	52	67
600x500	3600	59	58	54	54	54	55	55	52	61
	5735	61	60	58	57	56	58	58	55	64
	7865	60	62	63	62	62	60	60	54	67
	10000	63	62	63	64	64	63	63	55	70
600x600	4200	61	60	56	56	56	57	57	54	63
	6800	63	62	60	59	58	60	60	57	66
	9400	62	64	65	64	64	62	62	56	69
	12000	63	62	63	64	64	63	63	55	70

SERIE

RPMC-K

DATOS TÉCNICOS



Nivel de potencia sonora en el interior de la tubería con una diferencia de presión de 250 Pa

Dimensión [mm]	V [m³/h]	$\Delta P_{st} = 250 \text{ Pa}$								$L_{WA} \text{ [dB(A)]}$
		$L_w \text{ [dB(0kt)]}$								
		$f_m \text{ [Hz]}$								
		63	125	250	500	1000	2000	4000	8000	
200x100	250	54	53	49	49	49	50	50	47	56
	400	57	56	54	53	52	54	54	51	60
	550	56	58	59	58	58	56	56	52	63
	700	59	58	59	60	60	59	59	53	66
200x150	400	55	54	50	50	50	51	52	49	58
	600	58	57	55	54	53	55	55	52	61
	800	57	58	60	58	59	57	57	51	64
	1000	60	59	61	61	61	60	59	53	67
200x200	500	56	55	51	51	51	52	52	49	58
	765	58	57	55	54	53	55	55	52	61
	1035	57	59	60	59	59	57	57	51	64
	1300	60	59	60	61	61	60	60	52	67
300x100	400	56	55	51	51	51	52	52	49	58
	600	58	57	55	54	53	55	55	52	61
	800	57	59	60	59	59	57	57	51	64
	1000	60	59	60	61	61	60	60	52	67
300x150	500	56	55	51	51	51	52	52	49	58
	835	59	58	56	55	54	56	56	53	62
	1165	59	61	62	61	61	59	59	53	66
	1500	62	61	62	63	63	62	62	54	69
300x200	600	59	58	54	54	54	55	55	52	61
	1065	61	60	58	57	56	58	58	55	64
	1535	61	63	64	63	63	61	61	55	68
	2000	64	63	64	65	65	64	64	56	71
300x250	800	60	59	55	55	55	56	56	53	62
	1365	62	61	59	58	57	59	59	56	65
	1935	61	63	64	63	63	61	61	55	68
	2500	64	63	64	65	65	64	64	56	71
300x300	1000	61	60	56	56	56	57	57	54	63
	4665	63	62	60	59	58	60	60	57	66
	2335	62	64	65	64	64	62	62	56	69
	3000	65	64	65	66	66	65	65	57	72
400x200	900	61	60	56	56	56	57	57	54	63
	1500	62	61	59	58	57	59	59	56	65
	2100	61	63	64	63	63	61	61	55	68
	2700	63	62	63	64	64	63	63	55	70
400x250	1200	61	60	56	56	56	57	57	54	63
	1935	63	62	60	59	58	60	60	57	66
	2665	61	63	64	63	63	61	61	55	68
	3400	63	62	63	64	64	63	63	55	70
400x300	1500	62	61	57	57	57	58	58	55	64
	2400	64	63	61	60	59	61	61	58	67
	3300	64	65	66	65	65	63	63	57	70
	4200	66	65	66	67	67	66	66	58	73
400x400	1800	64	63	59	59	59	60	60	57	66
	3000	66	65	63	62	61	63	63	60	69
	4200	64	66	67	66	66	64	64	58	71
	5400	67	66	67	68	68	67	67	59	74

SERIE RPMC-K

DATOS TÉCNICOS



Nivel de potencia sonora en el interior de la tubería con una diferencia de presión de 250 Pa

$\Delta P_{st} = 250 \text{ Pa}$										
Dimensión [mm]	V [m³/h]	L_w [dB/Okt]								L_{WA} [dB(A)]
		f_m [Hz]								
		63	125	250	500	1000	2000	4000	8000	
500x200	1100	59	58	54	54	54	55	55	52	61
	1865	61	60	58	57	56	58	58	55	64
	2635	59	61	62	61	61	59	59	53	66
	3400	61	60	61	62	62	61	61	53	68
500x250	1500	61	60	56	56	56	57	57	54	63
	2400	62	61	59	58	57	59	59	56	65
	3300	60	62	63	62	62	60	60	54	67
	4200	62	61	62	63	63	62	62	54	69
500x300	1800	62	61	57	57	57	58	58	55	64
	2800	63	62	60	59	58	60	60	57	66
	3800	61	63	64	63	63	61	61	55	68
	4800	63	62	63	64	64	63	63	55	70
500x400	2200	65	64	60	60	60	61	61	58	67
	3735	67	66	64	63	62	64	64	61	70
	5265	66	68	69	68	68	66	66	60	73
	6800	69	68	69	70	70	69	69	61	76
500x500	3000	67	66	62	62	62	63	63	60	69
	4800	69	68	66	65	64	66	66	63	72
	6600	67	69	70	69	69	67	67	61	74
	8400	69	68	69	70	70	69	69	61	76
600x200	1500	59	58	54	54	54	55	55	52	61
	2335	61	60	58	57	56	58	58	55	64
	3165	59	61	62	61	61	59	59	53	66
	4000	62	61	62	63	63	62	62	54	69
600x250	1800	60	59	55	55	55	56	56	53	62
	2865	63	61	59	58	57	59	59	56	65
	3935	61	63	64	63	63	61	61	55	68
	5000	64	63	64	65	65	64	64	56	71
600x300	2100	62	61	57	57	57	58	58	55	64
	3400	63	62	60	59	58	60	60	57	66
	4700	61	63	64	63	63	61	61	55	68
	6000	63	62	63	64	64	63	63	55	70
600x400	3000	65	64	60	60	60	61	61	58	67
	4665	67	66	64	63	62	64	64	61	70
	6335	66	68	69	68	68	66	66	60	73
	8000	68	67	68	69	69	68	68	60	75
600x500	3600	67	66	62	62	62	63	63	60	69
	5735	69	68	66	65	64	66	66	63	72
	7865	68	70	71	70	70	68	68	62	75
	10000	71	70	71	72	72	71	71	63	78
600x600	4200	70	69	65	65	65	66	66	63	72
	6800	71	70	68	67	66	68	68	65	74
	9400	69	71	72	71	71	69	69	63	76
	12000	70	69	70	71	71	70	70	62	77

SERIE

RPMC-K

DATOS TÉCNICOS



Nivel de potencia sonora en el interior de la tubería con una diferencia de presión de 500 Pa

Dimensión [mm]	V [m³/h]	$\Delta P_{st} = 500 \text{ Pa}$								$L_{WA} \text{ [dB(A)]}$
		$L_w \text{ [dB/OkT]}$								
		$f_m \text{ [Hz]}$								
		63	125	250	500	1000	2000	4000	8000	
200x100	250	60	59	55	55	55	56	56	53	62
	400	63	62	60	59	58	60	60	57	66
	550	64	63	65	64	64	62	62	59	69
	700	66	65	66	67	67	66	65	61	73
200x150	400	62	61	57	57	56	58	57	54	64
	600	64	63	61	60	59	60	60	57	67
	800	63	65	66	65	65	63	63	57	70
	1000	66	65	67	67	67	66	66	58	73
200x200	500	62	61	57	57	57	58	58	55	64
	765	65	64	62	61	60	62	62	59	68
	1035	64	66	67	66	66	64	64	58	71
	1300	67	66	67	68	68	67	67	59	74
300x100	400	62	61	57	57	57	58	58	55	64
	600	64	63	61	60	59	61	61	58	67
	800	63	65	66	65	65	63	63	57	70
	1000	66	65	66	67	67	66	66	58	73
300x150	500	62	61	57	57	57	58	58	55	64
	835	65	64	62	61	60	62	62	59	68
	1165	65	67	68	67	67	65	65	59	72
	1500	68	67	68	69	69	68	68	60	75
300x200	600	65	64	60	60	60	61	61	58	67
	1065	68	67	65	64	63	65	65	62	71
	1535	67	69	70	69	69	67	67	61	74
	2000	70	69	70	71	71	70	70	62	77
300x250	800	67	66	62	62	62	63	63	60	69
	1365	69	68	66	65	64	66	66	63	72
	1935	68	70	71	70	70	68	68	62	75
	2500	71	70	71	72	72	71	71	63	78
300x300	1000	68	67	63	63	63	64	64	61	70
	4665	70	69	67	66	65	67	67	64	73
	2335	69	71	72	71	71	69	69	63	76
	3000	72	71	72	73	73	72	72	64	79
400x200	900	68	67	63	63	63	64	64	61	70
	1500	70	69	67	66	65	67	67	64	73
	2100	68	70	71	70	70	68	68	62	75
	2700	70	69	70	71	71	70	70	62	77
400x250	1200	67	66	62	62	65	63	63	60	70
	1935	70	69	67	66	66	67	67	64	73
	2665	68	70	71	70	66	68	68	62	75
	3400	70	69	70	71	71	70	70	62	77
400x300	1500	68	67	63	63	66	64	64	61	71
	2400	71	70	68	67	67	68	68	65	74
	3300	69	71	72	71	67	69	69	63	76
	4200	71	70	71	72	72	71	71	63	78
400x400	1800	71	69	65	65	68	66	66	63	73
	3000	73	72	70	69	69	70	70	67	76
	4200	71	73	74	73	69	71	71	65	78
	5400	73	72	73	74	74	73	73	65	80

SERIE

RPMC-K

DATOS TÉCNICOS



Nivel de potencia sonora en el interior de la tubería con una diferencia de presión de 500 Pa

$\Delta P_{st} = 500 \text{ Pa}$										
Dimensión [mm]	V [m³/h]	L_w [dB/Okt]								L_{WA} [dB(A)]
		f_m [Hz]								
		63	125	250	500	1000	2000	4000	8000	
500x200	1100	66	65	61	61	64	62	62	59	69
	1865	67	66	64	63	66	64	64	61	71
	2635	66	68	69	68	65	66	66	60	73
	3400	69	68	69	70	66	69	69	61	75
500x250	1500	67	66	62	62	65	63	63	60	70
	2400	68	67	65	64	67	65	65	62	72
	3300	67	69	70	69	66	67	67	61	74
	4200	70	69	70	71	67	70	70	62	76
500x300	1800	68	67	63	63	66	64	64	61	71
	2800	69	68	66	65	68	66	66	63	73
	3800	68	70	71	70	67	68	68	62	75
	4800	71	70	71	72	68	71	71	63	77
500x400	2200	70	69	65	65	68	66	66	63	73
	3735	72	71	69	68	71	69	69	66	76
	5265	72	74	75	74	74	72	72	66	79
	6800	76	75	76	77	74	76	76	68	82
500x500	3000	74	73	69	69	68	70	70	67	76
	4800	75	74	72	71	74	72	72	69	79
	6600	74	76	77	76	76	74	74	68	81
	8400	77	76	77	78	75	77	77	69	83
600x200	1500	66	65	61	61	60	62	62	59	68
	2335	67	66	64	63	66	64	64	61	71
	3165	66	68	69	68	68	66	66	60	73
	4000	70	69	70	71	68	70	70	62	76
600x250	1800	67	66	62	62	61	63	63	60	69
	2865	68	67	65	64	67	65	65	62	72
	3935	68	70	71	70	70	68	68	62	75
	5000	71	70	71	72	72	71	71	63	78
600x300	2100	68	67	63	63	63	64	64	61	70
	3400	69	68	66	65	64	66	66	63	72
	4700	67	69	70	69	69	67	67	61	74
	6000	69	68	69	70	70	69	69	61	76
600x400	3000	72	71	67	67	67	68	68	65	74
	4665	74	73	71	70	69	71	71	68	77
	6335	73	75	76	75	75	73	73	67	80
	8000	75	74	75	76	76	75	75	67	82
600x500	3600	74	73	69	69	69	70	70	67	76
	5735	75	74	72	71	70	72	72	69	78
	7865	74	76	77	76	76	74	74	68	81
	10000	77	76	77	78	78	77	77	69	84
600x600	4200	76	75	71	71	71	72	72	69	78
	6800	77	76	74	73	72	74	74	71	80
	9400	75	77	78	77	77	75	75	69	82
	12000	76	75	76	77	77	76	76	68	83

SERIE RPMC-K

DATOS TÉCNICOS



Nivel de potencia sonora L_{wa} (dB (A)) en el interior de la conducción

200x100

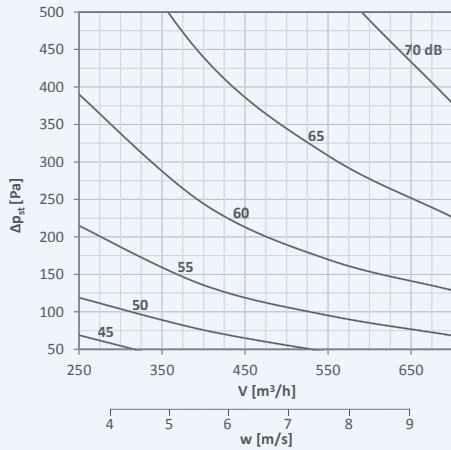

200x150

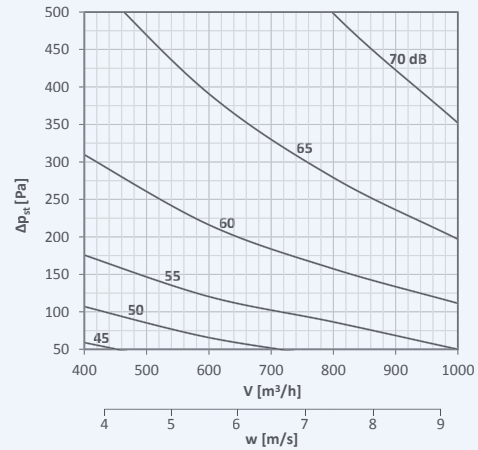

200x200

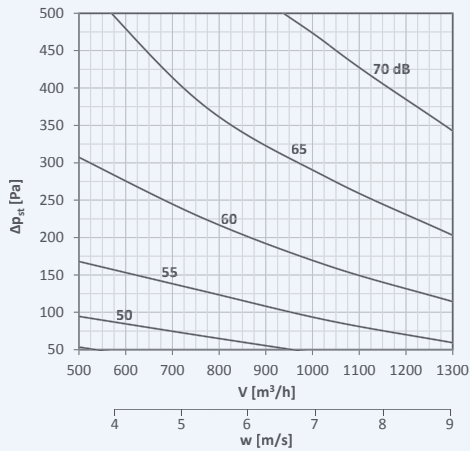

300x100

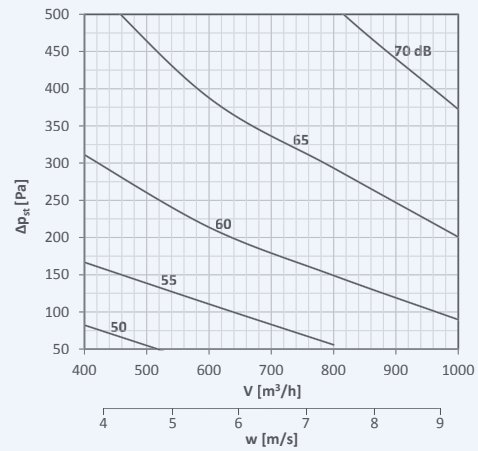

300x150

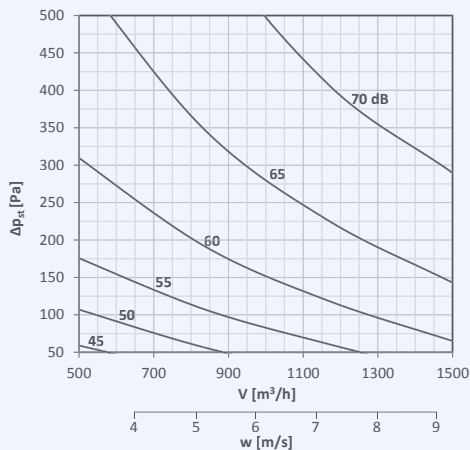

300x200

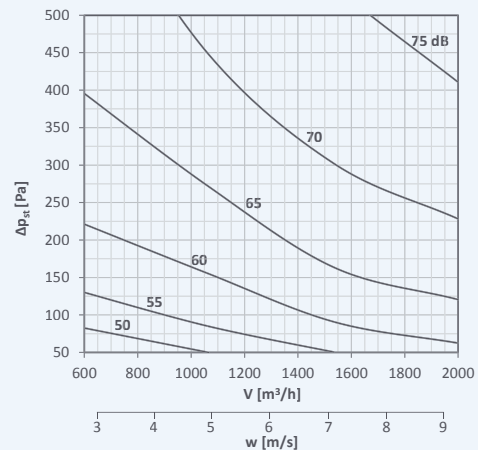

SERIE RPMC-K

DATOS TÉCNICOS



Nivel de potencia sonora L_{wa} (dB (A)) en el interior de la conducción

300x250

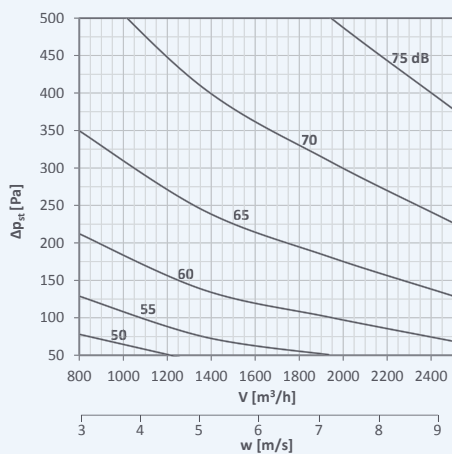

300x300

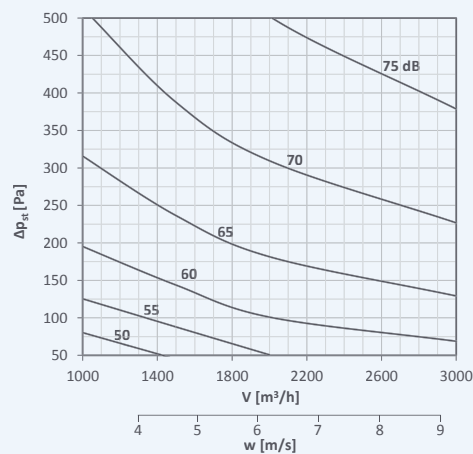

400x200

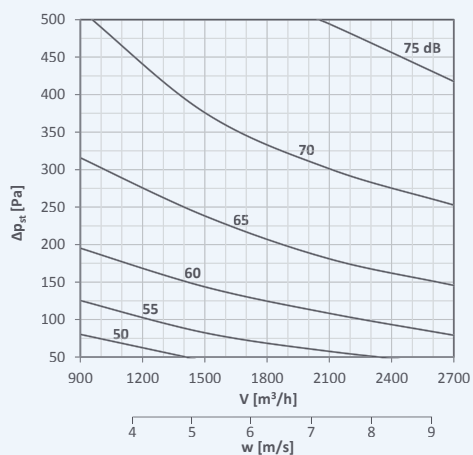

400x250

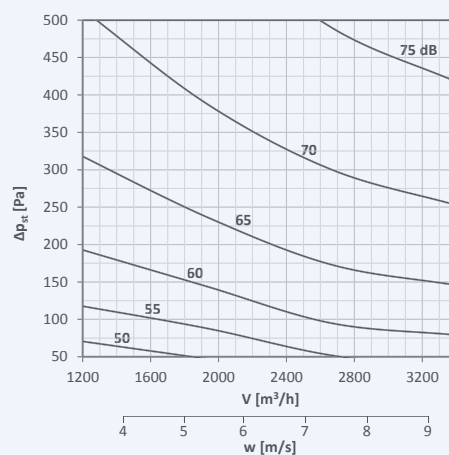

400x300

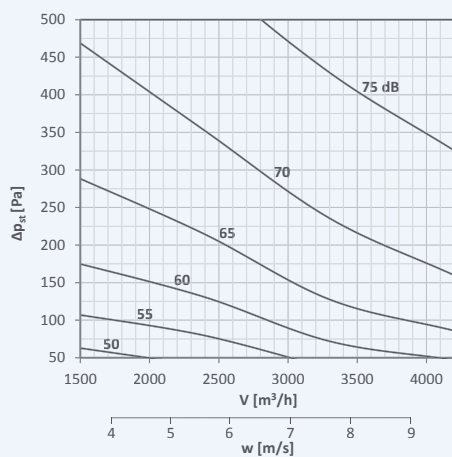

400x400

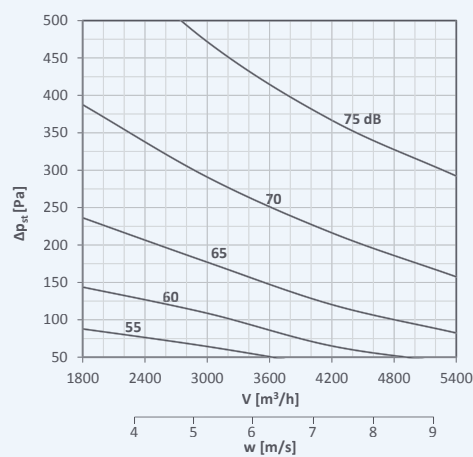

SERIE RPMC-K

DATOS TÉCNICOS



Nivel de potencia sonora L_{wa} (dB (A)) en el interior de la conducción

500x200

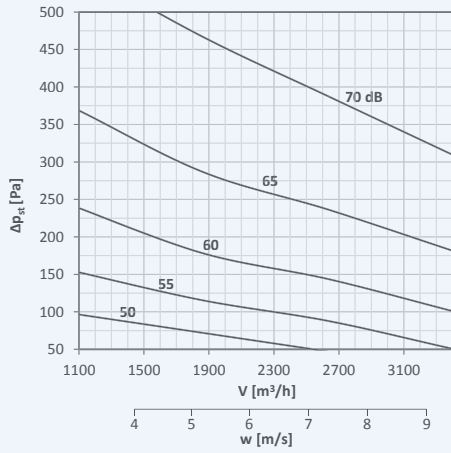

500x250

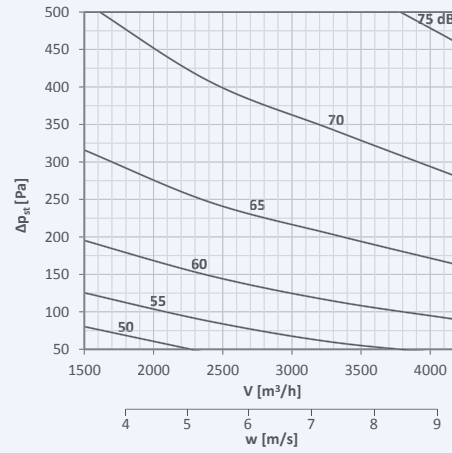

500x300

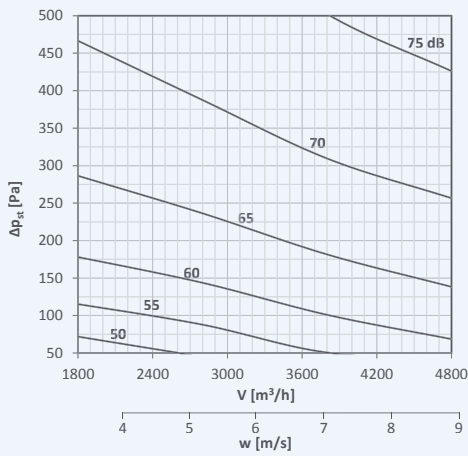

500x400

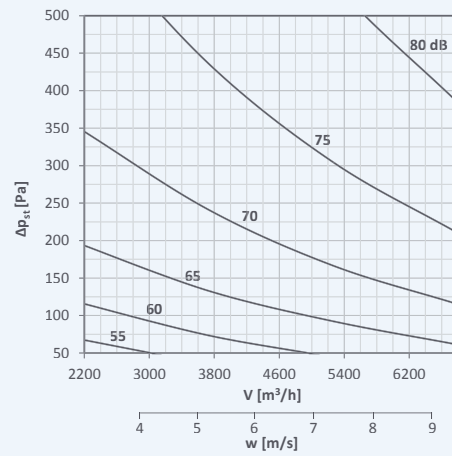

500x500

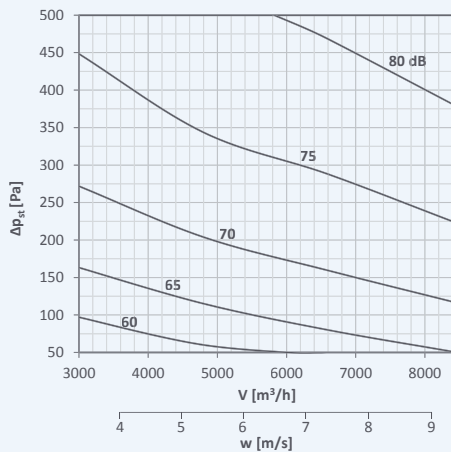

600x200

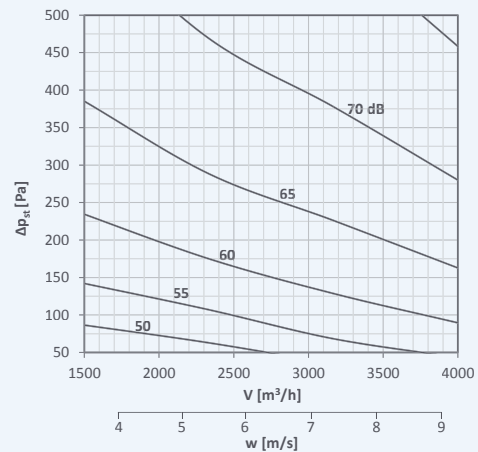

SERIE RPMC-K

DATOS TÉCNICOS



Nivel de potencia sonora L_{wa} (dB (A)) en el interior de la conducción

600x250

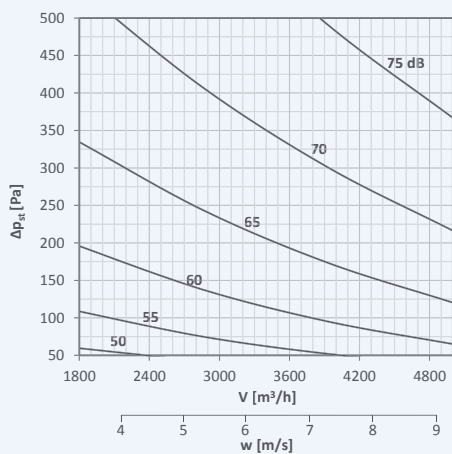

600x300

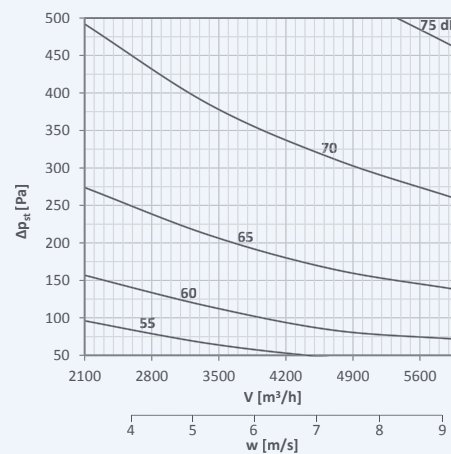

600x400

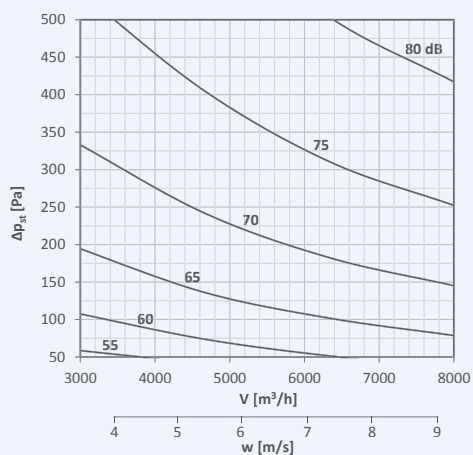

600x500

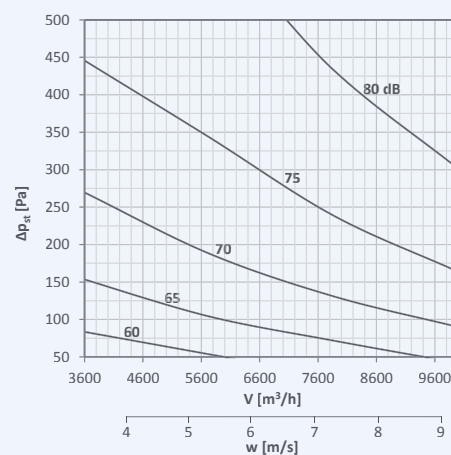

600x600

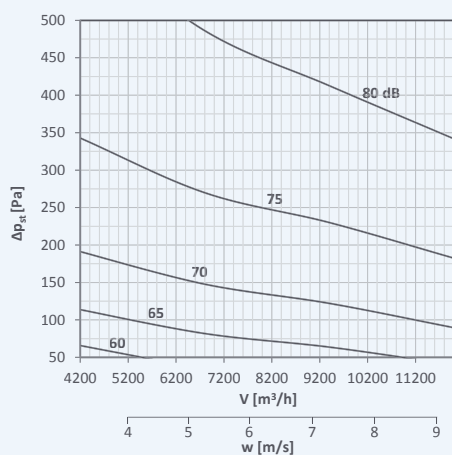

SERIE

RPMC-K

DATOS TÉCNICOS



Ruido radiado

El ruido radiado del controlador de volumen de aire se indica a continuación

V [m^3h^{-1}] - volumen de flujo de aire
 ΔP_{st} [Pa] - presión diferencial

L_{WA} [dB(A)] - nivel total de potencia acústica
 corregido por el filtro A

Dimensión [mm]	V [m^3/h]	L_{WA} [dB(A)]	L_{WA} [dB(A)]	L_{WA} [dB(A)]	L_{WA} [dB(A)]
		$\Delta P_{st}= 50$ Pa	$\Delta P_{st}= 100$ Pa	$\Delta P_{st}= 250$ Pa	$\Delta P_{st}= 500$ Pa
200x100	250	33	39	48	55
	400	38	43	51	57
	550	42	46	53	59
	700	45	49	55	61
200x150	400	34	39	46	52
	600	38	42	49	55
	800	41	45	52	58
	1000	43	48	55	61
200x200	500	35	40	47	53
	765	40	44	51	56
	1035	43	47	54	59
	1300	45	49	56	62
300x100	400	36	40	46	52
	600	40	44	50	56
	800	43	47	53	59
	1000	45	49	55	61
300x150	500	35	39	46	52
	835	40	44	51	57
	1165	44	48	54	60
	1500	47	51	57	63
300x200	600	35	40	48	54
	1065	39	44	52	58
	1535	43	48	55	61
	2000	46	51	58	64
300x250	800	36	41	49	56
	1365	40	45	53	60
	1935	44	49	56	63
	2500	47	52	59	66
300x300	1000	36	41	49	57
	4665	40	45	53	61
	2335	44	49	57	64
	3000	48	53	60	67
400x200	900	35	40	48	55
	1500	40	45	52	59
	2100	43	48	55	61
	2700	45	50	57	63
400x250	1200	38	43	50	56
	1935	42	47	54	60
	2665	45	50	57	63
	3400	47	52	59	65
400x300	1500	39	44	52	58
	2400	43	48	56	62
	3300	46	51	59	65
	4200	48	53	61	67
400x400	1800	43	48	56	62
	3000	46	51	59	65
	4200	48	53	61	67
	5400	50	55	63	69

SERIE RPMC-K

DATOS TÉCNICOS



Dimensión [mm]	V [m³/h]	L _{WA} [dB(A)]	L _{WA} [dB(A)]	L _{WA} [dB(A)]	L _{WA} [dB(A)]
		ΔP _{st} = 50 Pa	ΔP _{st} = 100 Pa	ΔP _{st} = 250 Pa	ΔP _{st} = 500 Pa
500x200	1100	35	40	48	55
	1865	40	45	52	58
	2635	43	48	55	61
	3400	47	51	58	63
500x250	1500	36	41	49	56
	2400	40	45	53	60
	3300	43	48	56	63
	4200	46	52	59	66
500x300	1800	38	43	51	57
	2800	42	47	55	61
	3800	44	49	58	64
	4800	47	52	60	66
500x400	2200	42	46	54	60
	3735	46	50	57	63
	5265	49	53	60	66
	6800	52	56	63	69
500x500	3000	45	50	57	63
	4800	48	53	60	66
	6600	51	56	63	68
	8400	55	59	65	70
600x200	1500	35	40	48	55
	2335	39	44	52	59
	3165	42	47	55	62
	4000	45	50	58	65
600x250	1800	36	42	50	56
	2865	40	45	53	60
	3935	43	48	56	63
	5000	46	51	59	66
600x300	2100	38	43	51	57
	3400	42	47	54	60
	4700	45	50	57	63
	6000	48	53	60	66
600x400	3000	40	45	53	60
	4665	44	49	56	63
	6335	47	52	59	65
	8000	51	55	61	67
600x500	3600	43	48	56	62
	5735	46	51	59	65
	7865	48	53	61	67
	10000	51	56	63	69
600x600	4200	45	50	57	63
	6800	48	53	60	66
	9400	51	55	62	68
	12000	53	57	64	70

SERIE RPMC-K

DATOS TÉCNICOS



Nivel de potencia sonora L_{wa} (dB (A)) en el interior de la conducción - sin aislamiento

200x100

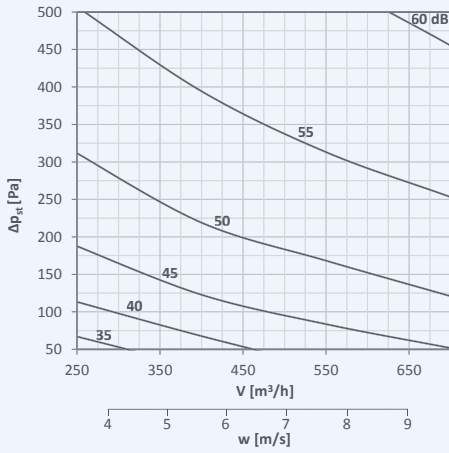

200x150

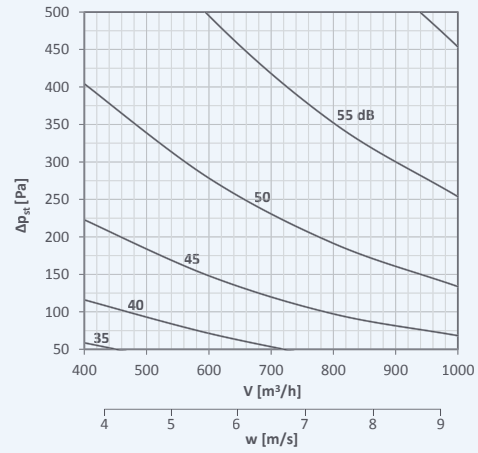

200x200

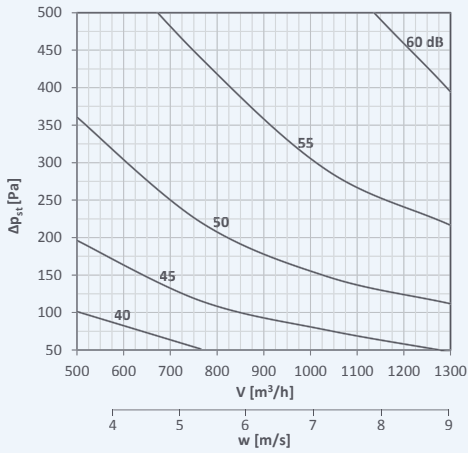

300x100

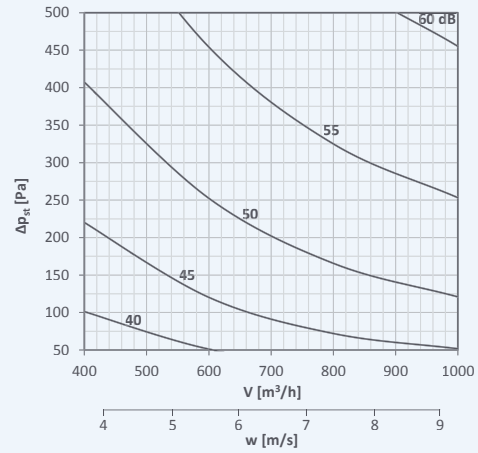

300x150

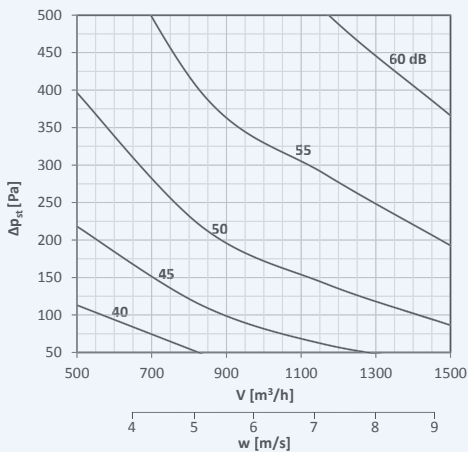

300x200

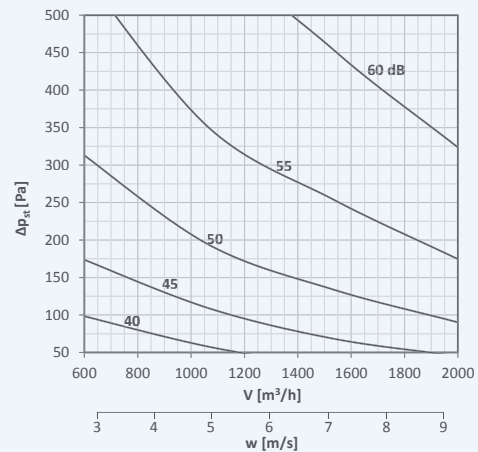

SERIE RPMC-K

DATOS TÉCNICOS



Nivel de potencia sonora L_{wa} (dB (A)) en el interior de la conducción - sin aislamiento

300x250

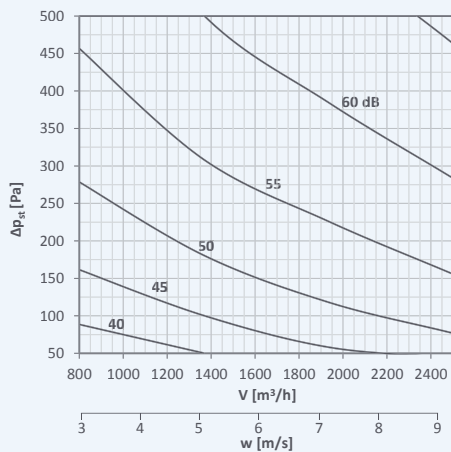

300x300

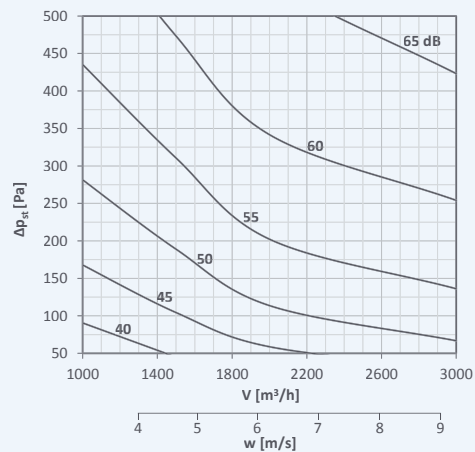

400x200

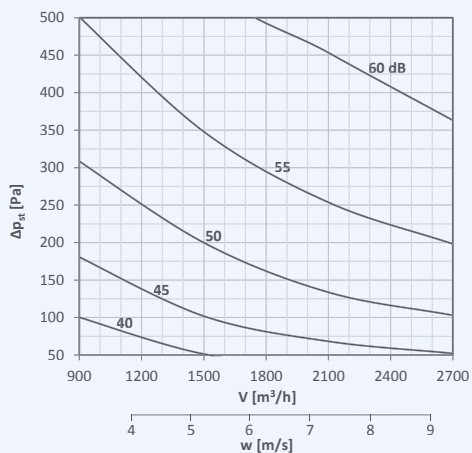

400x250

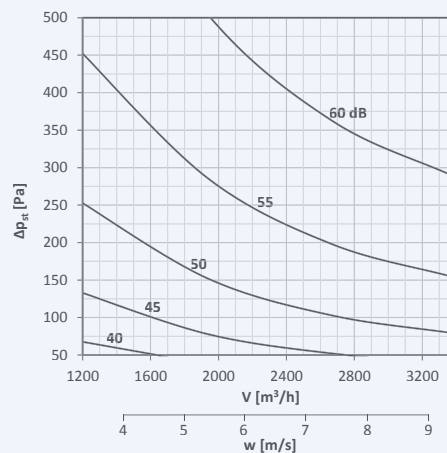

400x300

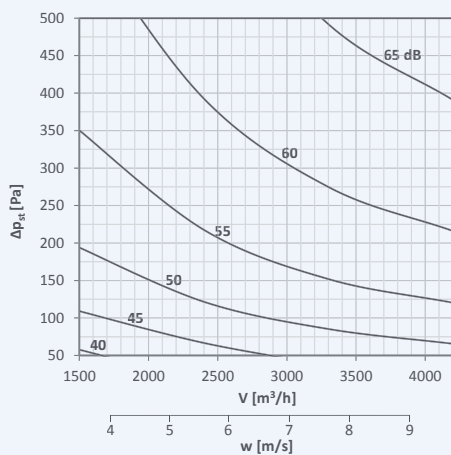

400x400

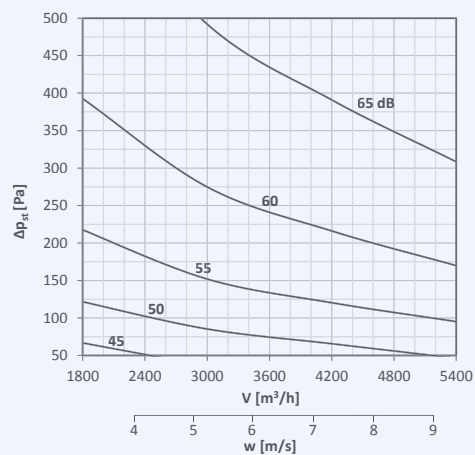

SERIE RPMC-K

DATOS TÉCNICOS



Nivel de potencia sonora L_{wa} (dB (A)) en el interior de la conducción- sin aislamiento

500x200

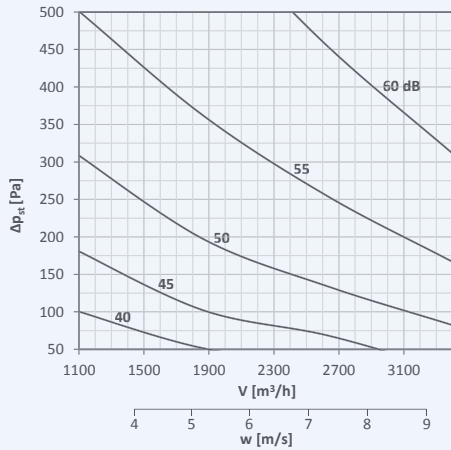

500x250

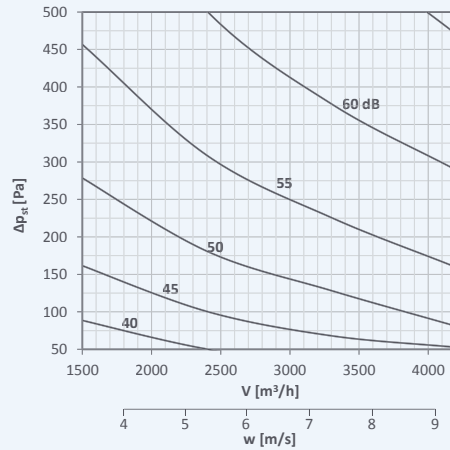

500x300

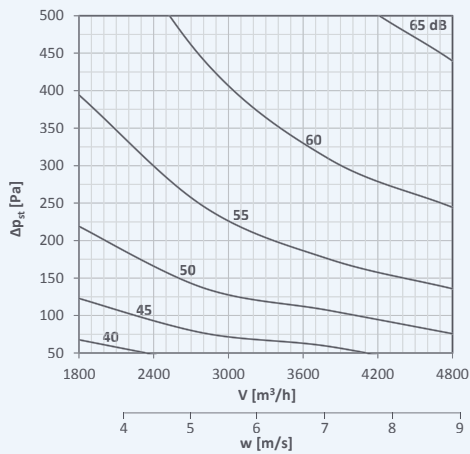

500x400

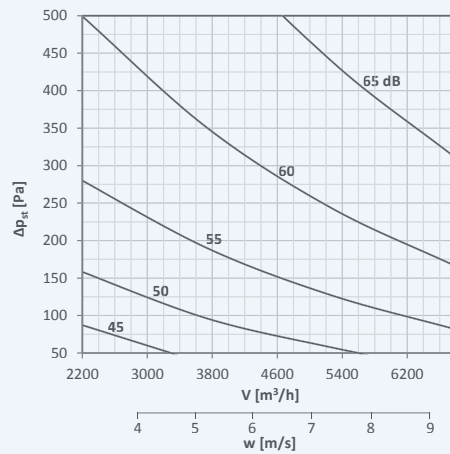

500x500

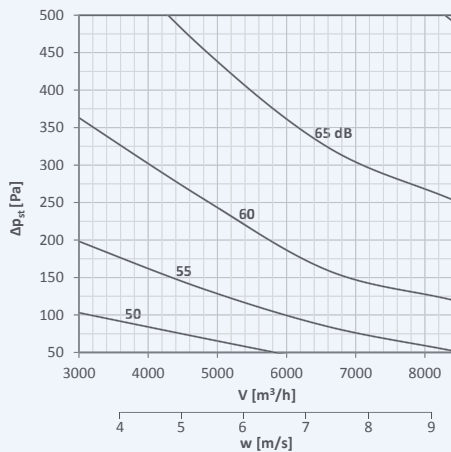

600x200

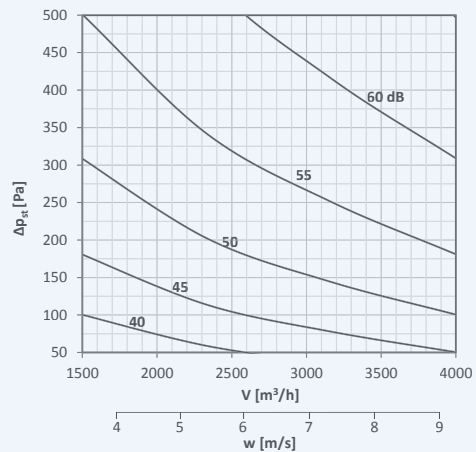

SERIE RPMC-K

DATOS TÉCNICOS



Nivel de potencia sonora L_{wa} (dB (A)) en el interior de la conducción - sin aislamiento

600x250

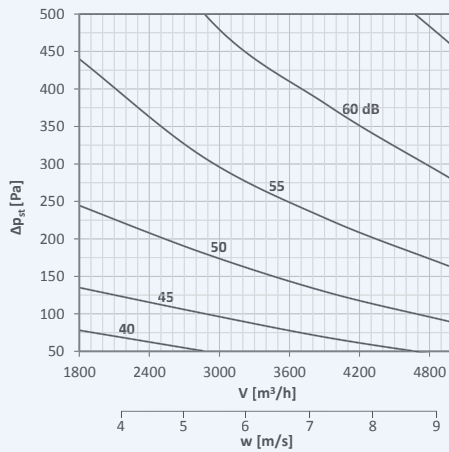

600x300

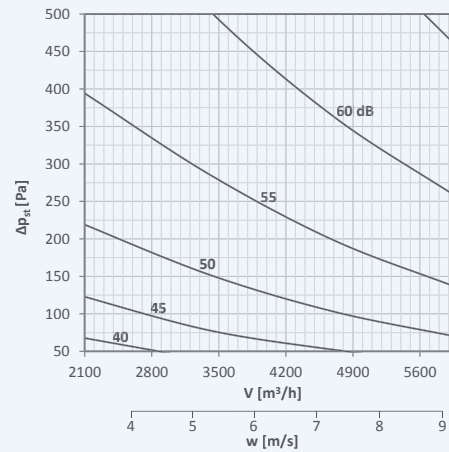

600x400

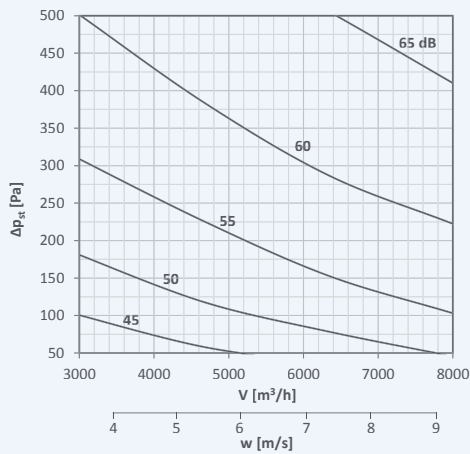

600x500

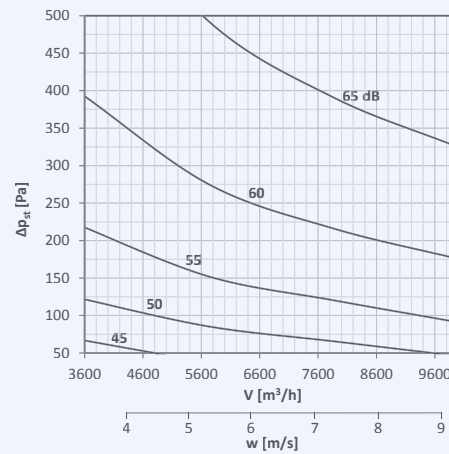

600x600

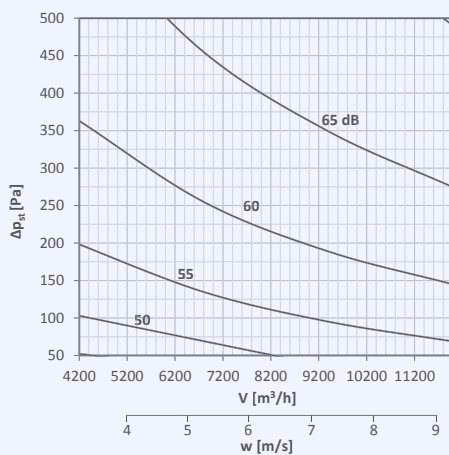

SERIE

RDR



REGULADOR DE CAUDAL

Modelo **RDR**. El regulador de caudal RDR es un elemento que se coloca en el interior del conducto para obtener un caudal constante dentro de un rango de presión de 50 a 250 pascales y se utiliza en sistemas de climatización o ventilación tanto en modo de extracción como de impulsión.

Características:

- Autoajustable en el rango de presión de 50 a 250 Pa
- Fácil ajuste
- El caudal de aire deseado se fija con un destornillador "torx nº10".
- Fabricado en material plástico (clasificado M1) y en acero galvanizado para manguitos de $\varnothing 150$ a $\varnothing 250$ mm
- Utilización con una temperatura máxima de 60°C.

Presentación:

- El regulador de caudal autoajustable RDR puede ajustarse in situ en función del caudal de aire deseado.
- Las marcas en los lados de la abertura indican los ajustes.

Ajuste:

- Antes de hacer funcionar el regulador, hay que calibrar el caudal:
- Afloje el tornillo de bloqueo del módulo de ajuste con un destornillador "torx nº 10".
- Ajuste la marca del módulo (situada a la izquierda o a la derecha) al caudal deseado.

Apriete el tornillo de bloqueo del módulo de ajuste.

- Los caudales distintos a los indicados en el regulador se pueden conseguir colocando la marca del módulo de ajuste en una posición intermedia

Modelos:

$\varnothing 80$ a $\varnothing 250$ mm.

SERIE

RDR



RDR
ø80 a ø125

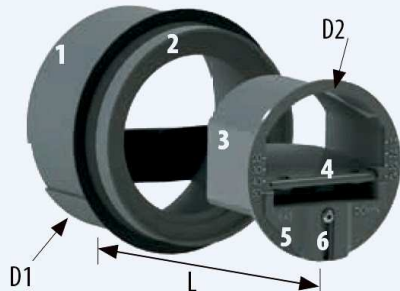

RDR
ø160 a ø250

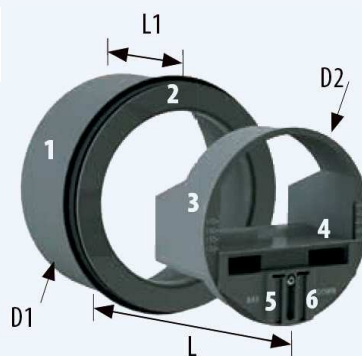

Tamaño	ØD1	ØD2	L
ø80	76	76	57
ø100	96	93	68
ø125	120	117	86 (68*)
ø160	148	148	85
ø200	195	195	91
ø250	244	245	120

* para caudales de 15 a 100 m³/h

Componentes y dimensiones:

1. Manguito con junta hermética
2. Espaciador (en función del caudal de aire)
3. Carcasa del regulador
4. Pieza de regulación
5. Ajuste del caudal de aire
6. Tornillo para fijar el caudal de aire

SERIE RDR

DATOS TÉCNICOS



Flujo de aire

Ø	Rango de caudal ajustable en (m3/h)	Caudales preestablecidos de fábrica (m3/h)*
80	15 à 50	15/25/30/45/50
100	15 à 50	15/25/30/45/50
100	50 à 100	60/75/90/100
125	15 à 50	15/25/30/45/50
125	50 à 100	60/75/90/100
125	100 à 180	120/150/180
160	15 à 50	50
160	50 à 100	100
160	180 à 300	120/150/180
160	180 à 300	210/240/250/270/300
200	100 à 180	180
200	180 à 300	210/240/250/270/300
200	300 à 500	350/400/450/500
250	180 à 300	300
250	300 à 500	350/400/450/500
250	450 à 800	550/600/650/700

Potencia sonora

Los controladores se caracterizan por sus niveles de potencia sonora Lw expresados en dB(A)

Ø (mm)	Caudal (m ³ /h)	Lw en dB (A)			
		50 Pa	100 Pa	150 Pa	200 Pa
80	15	24	30	33	35
	30	27	33	39	43
	45	27	33	39	42
	50	28	34	38	42
100	15	24	26	30	33
	30	27	33	37	42
	45	29	36	40	42
	60	31	37	41	44
	75	31	38	42	45
	90	33	39	43	46
125	100	33	39	43	46
	15	25	29	32	34
	30	27	32	37	42
	45	28	33	37	41
	60	30	35	39	43
	75	31	35	39	43
	90	32	35	39	43
	100	35	40	44	48
160	120	35	41	45	47
	150	36	42	45	47
	180	38	42	45	47
	100	38	44	46	49
	120	39	44	47	49
	150	40	45	49	51
	180	38	43	46	49
200	210	39	45	48	50
	240	40	44	47	49
	270	39	45	48	50
	300	41	46	49	51
	350	41	47	50	52
	400	41	47	51	53
	450	41	47	51	53
	500	42	48	52	54