



REGULACIÓN CAUDAL VARIABLE

SERIES RPM-V - RPMC-V

Los reguladores de volumen de aire están pensados para sistemas con un volumen de aire variable que se utiliza para la entrada o salida de aire. La cantidad de aire necesaria que se introduce en las distintas salas o zonas de trabajo es variable con respecto al tiempo y puede cambiarse según la necesidad momentánea cuando los controladores están instalados. La potencia total del sistema de aire acondicionado puede ser menos. Esta variable permite un funcionamiento más económico de los sistemas de aire acondicionado y al mismo tiempo garantizan el bienestar individual en la configuración de los locales.

REGULACIÓN CAUDAL VARIABLE

SERIES RPM-V - RPMC-V

RPM-V Regulador de caudal de aire, con flujo variable. Circular

RPMC-V Regulador de caudal de aire, con flujo variable. Cuadrado



RPM-V

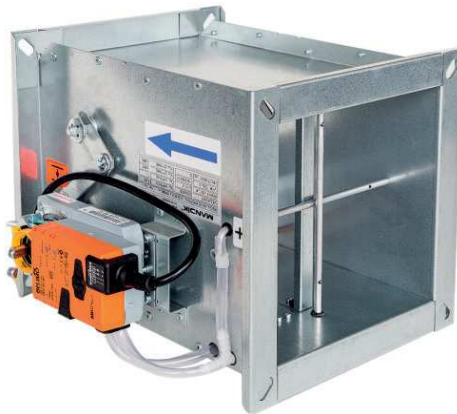

RPMC-V

SERIE

RPM-V



COMPUERTA CAUDAL VARIABLE

Modelo **RPM-V**. Los reguladores de volumen de aire están pensados para sistemas con un volumen de aire variable que se utiliza para la entrada o salida de aire. La cantidad de aire necesaria que se introduce en las distintas salas o zonas de trabajo es variable con respecto al tiempo y puede cambiarse según la necesidad momentánea cuando los controladores están instalados. La potencia total del sistema de aire acondicionado puede ser menor. Esta variable permiten un funcionamiento más económico de los sistemas de aire acondicionado y al mismo tiempo garantizan el bienestar individual en la configuración de los locales.

El controlador consiste en el cuerpo del controlador con una hoja de control y sondas de presión para determinar el flujo de aire. En el cuerpo del regulador se encuentra un regulador compacto para controlar la la hoja de control.

Características:

- Tipo de regulación:
control del caudal de aire
control de la presión en el conducto
control de la presión en el local
- Tamaño nominal: DIM 80 a DIM 630
- Longitud L = 450 / 600 mm según el tamaño nominal
- Estanqueidad según la norma EN 1751 Estanqueidad exterior de la carcasa clase C Estanqueidad a través de la hoja de la compuerta: clase 4
- Volumen de flujo de aire 18 ÷ 7 900 m³/h (para 12m/s es un volumen def lujo de aire máximo de 13 500 m³/h)
- Precisión ± 8 % para velocidad hasta 3 m/s y ± 5 % para velocidad superior.
- Velocidad del aire La configuración estándar está en el rango de min. 1 m/s a 7 m/s por Belimo.

Condiciones de trabajo:

- El funcionamiento correcto de los reguladores está garantizado en las siguientes condiciones a) velocidad máxima del flujo de aire 7 m/s
b) presión máxima en el conducto 1000 Pa
c) la circulación de aire en toda la sección del regulador debe estar asegurada como constante en toda superficie
- Los reguladores están diseñados para zonas macroclimáticas con clima suave según la norma EN 60 721-3-3.
- Los reguladores son adecuados para sistemas sin partículas abrasivas, químicas y adhesivas. La temperatura en el lugar de instalación puede oscilar entre 0°C y +50°C.
- Los reguladores se suministran sin aislamiento o con un diseño aislado. El grosor del aislamiento es de 50 mm.

Modelos:

- RPM-V.01** Para control con señal 0(2)...10 V o protocolo MP-BUS.
- RPM-V.02** Para control con la señal 0(2)...10 V o utilizando el protocolo Modbus RTU, BACnet o MP-BUS

Opcionales:

- RPM-V.75**
RPM-V.78
RPM-V.91
RPM-V.92

* ver descripción de modelos en tabla.

* Flujo de aire		solución compacta (sensor, controlador y actuador en una sola caja)		Dinámico	Analog MPBus (5 N.m, NMV-D3-MP 10 N.m, SMV-D3-MP 20 N.m)	LMV-D3-MP	0...500Pa	.01
Presión		sensor, controller and actuador all in separate boxes		Estática	MODBUS BACnet MPBus (5 N.m, NMV-D3-MOD 10 N.m, SMV-D3-MOD 20 N.m)	LMV-D3-MOD	0...500Pa	.02
Presión en la sala		sensor, controller and actuador all in separate boxes		Estática	Analog MP-Bus (5 N.m., NM24A-VST 10 N.m, SM24A-VST 20 N.m)	Controlador VRU-M1-BAC (STP) + LM24A-VST	0...600 Pa	.75
					ModBus (5 N.m., NM24A-VST 10 N.m, SM24A-VST 20 N.m)	Controlador VRU-M1-BAC (STP) + LM24A-VST	0...600 Pa	.78
					BACnet (5 N.m., NM24A-VST 10 N.m, SM24A-VST 20 N.m)	Controlador VRU-M1R-BAC (STP) + LM24A-VST	-75...+75	.91
					ModBus BACnet (5 N.m., NM24A-VST 10 N.m, SM24A-VST 20 N.m)	Controlador VRU-M1R-BAC (STP) + LM24A-VST	-75...+75	.92

SERIE RPM-V



RPM-V

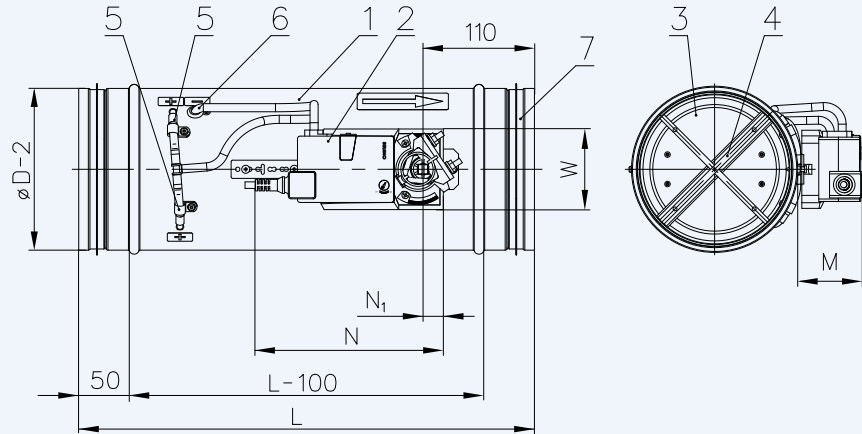

1. Cuerpo del regulador
2. Controlador
3. Hoja del controlador
4. Pestaña
5. Muestreo de presión -p1
6. Muestreo de presión -p2
7. Junta de goma

RPM-V

Control de flujo de aire

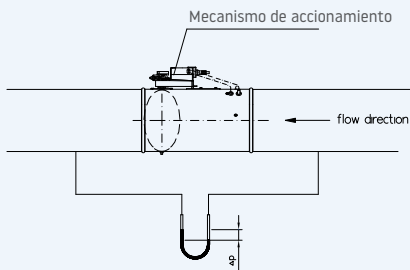

Δp [Pa] pérdida de presión del controlador

RPM-V

Control de la presión del conducto

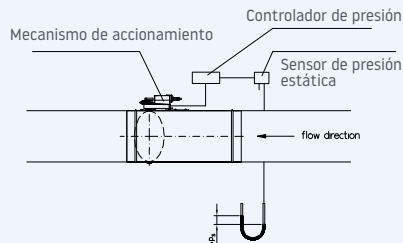

Δp_s [Pa] Diferencia de presión estática entre el conducto y el entorno

RPM-V

Control de la presión de la sala

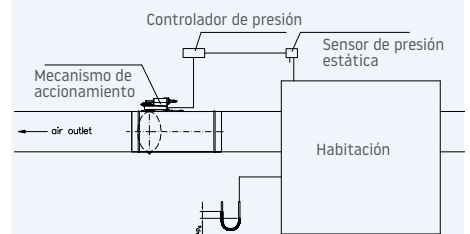

Δp_s [Pa] Diferencia de presión estática entre la sala y el entorno

RPM-V

Distancia recomendada con respecto a la unión de la rama doble

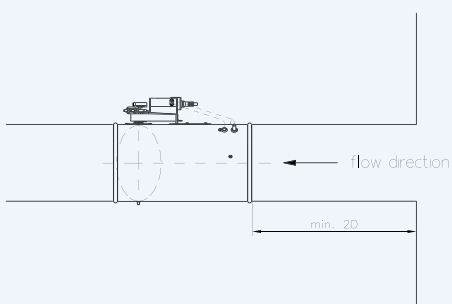

RPM-V

Distancia recomendada de la curva

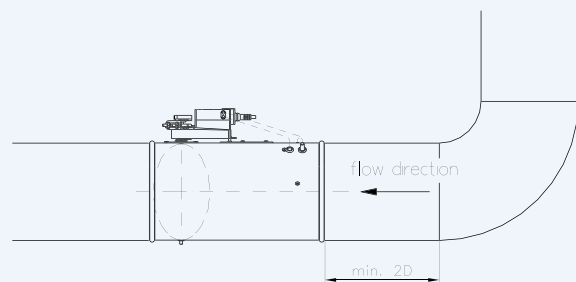

SERIE RPM-V

DATOS TÉCNICOS



Volumen de aire

Dimensiones AxB [mm]	Volumen de aire [m³/h]					
	Valores estándar*			Valores máximos		
	Mínimo (w ≈ 1m/s)	Máximo (w ≈ 7m/s)	V _{nom}	Mínimo (w ≈ 1m/s)	Máximo (w ≈ 12m/s)	V _{nom}
80	18	125	125	18	220	220
100	30	200	200	30	350	350
125	45	310	310	45	550	550
140	55	400	400	55	700	700
160	70	500	500	70	900	900
180	90	650	650	90	1200	1200
200	115	800	800	115	1400	1400
225	145	1000	1000	145	1800	1800
250	180	1250	1250	180	2200	2200
280	220	1550	1550	220	2800	2800
315	280	2000	2000	280	3500	3500
355	355	2500	2500	355	4500	4500
400	455	3200	3200	455	5800	5800
500	710	5000	5000	710	8500	8500
630	1120	7900	7900	1120	13500	13500

*Configuración por defecto del controlador

SERIE RPM-V

DATOS TÉCNICOS



Determinación del volumen de aire efectivo

El valor del volumen de aire se determina mediante el cálculo a partir del valor medido U_5

Ejemplo: Modo de funcionamiento 2...10V

$$\dot{V} = \frac{U_5 - 2,0}{8} \cdot \dot{V}_{nom}$$

Ejemplo: Modo de funcionamiento 0...10V

$$\dot{V} = \frac{U_5 \cdot \dot{V}_{nom}}{10}$$

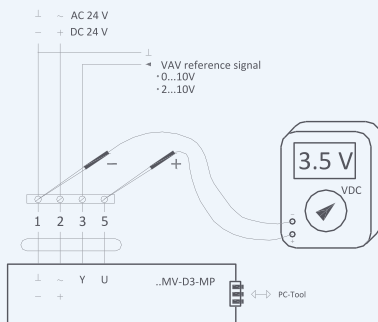

Búsqueda para: volumen de aire efectivo

Tensión medida en U_5 : 3,5 V

$$\dot{V}_{nom} = 2800 \text{ m}^3 \cdot \text{h}^{-1}$$

$$\dot{V} = \frac{3,5 - 2,0}{8} \cdot 2800 = 525$$

El volumen de aire actual es 525 $\text{m}^3 \cdot \text{h}^{-1}$.

Búsqueda para: volumen de aire efectivo

Tensión medida en U_5 : 3,5 V

$$\dot{V}_{nom} = 2200 \text{ m}^3 \cdot \text{h}^{-1}$$

$$\dot{V} = \frac{3,5 \cdot 2200}{10} = 770$$

El volumen de aire actual es 770 $\text{m}^3 \cdot \text{h}^{-1}$.

Pérdida de presión

Pérdidas de presión (los valores son válidos cuando la compuerta del regulador está completamente abierta)

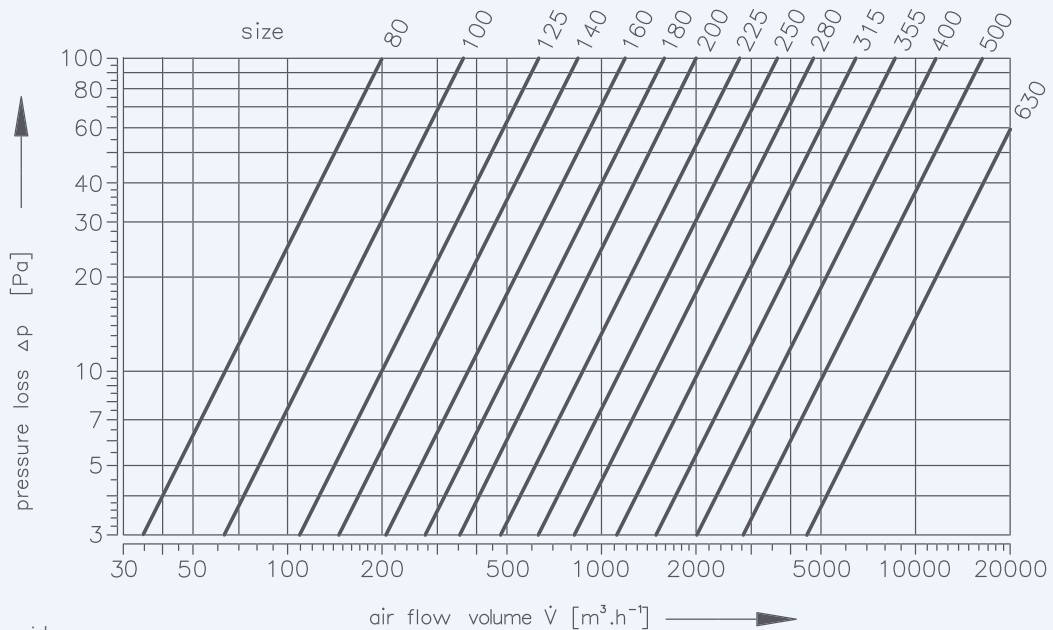

Información de ruido
Ruido regenerado por el aire

El ruido producido por el flujo del regulador de volumen de aire se indica en las siguientes tablas

V [$\text{m}^3 \cdot \text{h}^{-1}$] - volumen de flujo de aire

Δp [Pa] - presión diferencial

L_w [dB/Okt.] - nivel de potencia acústica en la banda de octava

L_{WA} [dB(A)] - nivel total de potencia acústica corregido por el filtro A

f_m [Hz] - frecuencias medias en las bandas de octava

SERIE

RPM-V

DATOS TÉCNICOS



REGULACIÓN

Nivel de potencia sonora en el interior de la tubería con una diferencia de presión de 50 Pa

$\Delta P_{st} = 50 \text{ Pa}$

Dimensión [mm]	V [m³/h]	L_w [dB/Okt]								L_{WA} [dB(A)]
		f_m [Hz]								
		63	125	250	500	1000	2000	4000	8000	
80	18	40	31	31	25	28	24	18	7	32
	88	54	44	38	38	41	37	29	18	44
	154	59	49	43	43	46	43	35	23	49
	220	63	53	47	47	50	46	38	27	53
100	30	42	33	27	27	31	26	20	9	34
	140	58	49	45	45	43	39	39	22	48
	245	65	58	54	54	49	50	41	29	56
	350	69	63	59	59	51	53	42	31	60
125	45	44	34	28	28	31	28	20	10	34
	220	59	50	46	43	44	41	34	24	48
	385	64	56	52	48	47	43	40	28	52
	550	71	63	59	54	51	43	44	34	57
140	55	45	36	30	30	33	29	21	11	36
	280	61	52	49	45	43	40	36	25	49
	490	64	57	53	49	48	44	40	28	53
	700	72	64	60	55	52	48	45	35	58
160	70	48	39	32	32	36	32	23	14	39
	360	60	51	47	44	46	41	34	24	49
	630	66	58	54	50	49	45	41	30	54
	900	72	65	60	57	54	49	46	35	59
180	90	48	38	33	33	36	32	24	13	39
	480	60	51	47	45	45	42	35	24	49
	840	66	58	55	51	50	46	42	30	55
	1200	74	66	62	57	54	50	47	37	60
200	115	47	36	31	31	35	33	24	13	39
	560	60	51	47	45	46	42	35	24	49
	980	68	60	56	52	51	47	43	31	56
	1400	75	67	63	58	55	51	38	38	61
225	145	49	39	33	33	36	32	25	13	39
	720	60	51	47	45	46	42	35	24	49
	1260	68	60	56	52	51	47	43	32	56
	1800	75	67	63	59	56	52	49	38	61
250	180	48	36	32	32	34	31	23	12	38
	880	61	53	49	46	47	43	36	26	51
	1540	68	61	57	53	52	48	44	32	57
	2200	74	66	63	58	55	51	48	37	61
280	220	50	40	34	34	36	33	27	15	40
	1120	64	56	52	49	50	46	39	28	54
	1960	69	62	58	54	53	49	45	33	58
	2800	77	69	65	60	57	50	50	39	63
315	280	49	55	34	34	37	33	25	15	42
	1400	63	55	51	48	49	45	38	27	53
	2450	70	62	58	54	53	49	45	34	58
	3500	78	70	66	61	58	54	51	40	64
355	355	51	41	36	36	39	37	28	17	43
	1800	63	54	50	47	48	44	38	27	52
	3150	70	62	58	54	53	49	45	34	58
	4500	77	69	65	60	57	53	50	40	63
400	455	53	44	38	38	41	37	29	18	44
	2320	63	54	50	47	48	44	38	27	52
	4060	70	62	58	54	53	49	45	34	58
	5800	76	68	64	59	57	53	50	39	63
500	710	49	40	34	34	37	33	25	15	40
	4200	64	55	51	48	49	45	39	28	53
	6300	71	63	59	55	54	50	46	35	59
	8500	77	69	65	60	58	54	51	40	63
630	1120	52	44	38	38	41	37	30	20	44
	6700	66	57	53	50	51	47	40	30	55
	10000	73	65	61	57	56	52	48	37	61
	13500	78	70	66	62	60	56	53	42	65

SERIE

RPM-V

DATOS TÉCNICOS



Nivel de potencia sonora en el interior de la tubería con una diferencia de presión de 100 Pa

$\Delta P_{st} = 100 \text{ Pa}$

Dimensión [mm]	V [m³/h]	L_w [dB/Okt]								L_{WA} [dB(A)]
		f_m [Hz]								
		63	125	250	500	1000	2000	4000	8000	
80	18	46	36	30	30	34	29	21	9	37
	88	59	49	43	43	46	42	34	22	49
	154	64	54	48	48	51	47	39	27	54
	220	68	58	52	52	55	51	43	31	58
100	30	48	38	32	32	35	31	23	12	38
	140	63	54	50	50	48	44	37	26	52
	245	70	62	59	59	53	49	45	33	60
	350	73	66	64	64	55	51	47	35	64
125	45	49	39	33	33	37	32	24	13	40
	220	65	56	52	50	49	45	39	28	53
	385	69	61	57	53	52	48	44	32	57
	550	76	68	64	59	56	52	49	38	62
140	55	51	41	35	35	38	34	26	14	41
	280	65	56	52	49	50	46	39	28	54
	490	70	62	58	54	53	49	45	33	58
	700	77	69	65	60	57	53	50	39	63
160	70	54	44	38	38	41	37	30	17	44
	360	65	56	52	49	50	46	39	28	54
	630	71	63	59	55	54	50	46	34	59
	900	78	70	66	61	58	54	51	40	64
180	90	54	44	38	38	41	37	29	17	44
	480	66	57	53	50	51	47	40	29	55
	840	72	64	60	56	55	51	47	35	60
	1200	79	71	67	62	59	55	52	41	65
200	115	54	44	38	38	42	37	29	18	45
	560	66	57	53	50	51	47	40	29	55
	980	73	65	61	57	56	52	48	36	61
	1400	80	72	68	63	60	56	53	42	66
225	145	55	45	39	39	43	38	29	18	46
	720	66	57	53	50	51	47	40	29	55
	1260	73	65	61	57	56	52	48	36	61
	1800	80	72	68	63	60	56	53	42	66
250	180	52	43	37	37	41	36	28	16	44
	880	67	58	54	51	52	48	41	30	56
	1540	73	65	61	57	56	52	48	36	61
	2200	79	71	67	62	59	55	52	41	65
280	220	55	45	39	39	43	39	31	19	46
	1120	70	61	57	54	55	51	44	33	59
	1960	74	66	62	58	57	53	49	37	62
	2800	81	73	69	64	61	57	54	43	67
315	280	56	46	41	41	44	41	32	20	47
	1400	69	60	56	53	54	50	43	32	58
	2450	75	67	63	59	58	54	50	38	63
	3500	82	74	70	65	62	58	55	44	68
355	355	58	48	42	42	46	41	33	31	49
	1800	69	60	56	53	54	50	43	32	58
	3150	75	67	63	59	58	55	51	39	63
	4500	82	74	70	65	62	58	55	44	68
400	455	58	49	42	42	46	42	34	22	49
	2320	69	60	56	53	54	50	43	32	58
	4060	76	68	64	60	59	55	51	39	64
	5800	82	74	70	65	62	58	55	44	68
500	710	56	46	40	40	43	39	31	21	46
	4200	69	60	56	53	54	51	44	33	58
	6300	77	69	65	61	60	56	52	40	65
	8500	82	74	70	65	62	59	56	45	68
630	1120	60	49	44	44	45	43	35	23	49
	6700	72	63	59	56	57	53	46	35	61
	10000	79	71	67	63	62	58	54	42	67
	13500	85	77	73	68	65	61	58	47	71

SERIE

RPM-V

DATOS TÉCNICOS



REGULACIÓN

Nivel de potencia sonora en el interior de la tubería con una diferencia de presión de 250 Pa

$\Delta P_{st} = 250 \text{ Pa}$

Dimensión [mm]	V [m³/h]	L_w [dB/Okt]								L_{WA} [dB(A)]
		f_m [Hz]								
		63	125	250	500	1000	2000	4000	8000	
80	18	54	44	38	38	41	37	29	17	44
	88	67	57	51	51	54	50	42	30	57
	154	72	62	56	56	59	55	47	35	62
	220	76	66	60	60	63	59	51	39	66
100	30	56	46	41	41	43	40	32	20	47
	140	70	61	57	57	55	52	44	33	60
	245	77	69	65	66	61	55	52	40	67
	350	83	75	71	72	63	59	56	45	72
125	45	58	48	42	42	45	41	33	21	48
	220	70	61	58	55	56	51	45	34	60
	385	77	69	65	61	60	55	51	39	65
	550	83	75	71	65	62	58	55	44	69
140	55	60	50	44	44	48	44	35	23	51
	280	72	63	59	56	57	53	46	35	61
	490	77	69	65	61	60	56	52	40	65
	700	83	75	71	66	63	59	56	45	69
160	70	61	51	45	45	49	44	36	24	52
	360	73	64	60	57	58	54	47	36	62
	630	78	70	66	62	61	57	53	41	66
	900	84	76	72	67	64	60	57	46	70
180	90	63	53	47	47	50	45	37	25	53
	480	73	65	62	59	58	55	47	36	63
	840	78	71	67	63	62	57	53	41	67
	1200	84	77	74	69	65	61	57	46	72
200	115	63	53	47	47	51	46	38	26	54
	560	74	65	61	58	59	55	48	37	63
	980	79	72	68	64	63	58	54	42	68
	1400	85	77	73	69	65	61	58	47	72
225	145	64	54	48	48	51	49	40	28	55
	720	74	65	61	58	59	55	48	37	63
	1260	80	72	68	64	63	59	55	43	68
	1800	86	78	74	69	66	62	59	48	72
250	180	64	55	48	48	50	47	40	27	54
	880	74	65	61	58	59	55	48	37	63
	1540	80	72	68	64	63	59	55	43	68
	2200	86	78	74	69	66	62	59	48	72
280	220	65	55	49	49	53	48	41	29	56
	1120	76	67	63	60	61	56	49	38	65
	1960	81	73	69	65	64	60	56	44	69
	2800	87	79	75	70	67	63	60	49	73
315	280	66	57	50	50	53	51	43	30	57
	1400	76	67	63	60	61	57	50	39	65
	2450	82	74	70	66	65	61	57	45	70
	3500	88	80	76	71	68	64	61	50	74
355	355	67	57	51	51	54	52	43	31	58
	1800	77	68	64	61	62	58	51	40	66
	3150	82	75	71	67	67	62	57	45	71
	4500	88	80	76	71	68	64	61	50	74
400	455	70	60	54	54	58	53	45	33	61
	2320	77	69	65	62	63	59	51	40	67
	4060	82	75	71	67	66	62	57	45	71
	5800	88	80	76	71	68	64	61	50	74
500	710	66	56	50	50	53	49	42	30	56
	4200	79	70	66	63	64	60	53	42	68
	6300	84	76	73	69	68	63	59	47	73
	8500	90	82	78	73	70	66	63	52	76
630	1120	68	58	50	50	52	50	43	31	56
	6700	81	72	68	65	66	62	55	44	70
	10000	86	79	75	71	70	65	61	49	75
	13500	92	84	80	75	72	68	65	54	78

SERIE

RPM-V

DATOS TÉCNICOS



Nivel de potencia sonora en el interior de la tubería con una diferencia de presión de 500 Pa

$\Delta P_{st} = 500 \text{ Pa}$

Dimensión [mm]	V [m³/h]	L_w [dB/Okt]								L_{WA} [dB(A)]
		f_m [Hz]								
		63	125	250	500	1000	2000	4000	8000	
80	18	61	51	45	45	48	46	37	25	52
	88	74	64	58	58	61	58	50	38	64
	154	79	70	63	63	66	62	54	42	69
	220	83	73	67	68	70	67	59	47	73
100	30	64	54	48	48	51	47	39	27	54
	140	77	68	64	64	62	58	51	40	66
	245	84	76	72	72	67	63	59	47	73
	350	90	82	78	78	70	66	63	52	78
125	45	66	54	50	50	54	50	41	29	57
	220	78	69	65	61	63	58	51	40	66
	385	83	75	71	67	66	63	59	47	71
	550	89	81	77	72	69	66	63	52	75
140	55	67	57	51	51	54	50	42	30	57
	280	79	70	66	63	64	60	53	42	68
	490	81	76	72	68	67	63	59	47	72
	700	89	81	77	72	69	65	62	51	75
160	70	69	59	53	53	56	52	44	32	59
	360	81	72	68	65	66	62	55	44	70
	630	86	78	74	70	69	65	61	49	74
	900	91	83	79	74	71	67	64	53	77
180	90	70	60	54	54	58	53	45	33	61
	480	81	72	68	65	66	62	55	44	70
	840	86	78	74	70	69	65	61	49	74
	1200	92	84	80	75	72	68	65	54	78
200	115	71	61	55	55	59	54	46	34	62
	560	81	72	68	65	66	62	55	44	70
	980	86	78	74	70	69	65	61	49	74
	1400	92	84	80	75	72	68	65	54	78
225	145	72	62	56	56	60	55	47	35	63
	720	81	72	68	65	66	62	55	44	70
	1260	86	78	74	70	69	65	61	49	74
	1800	91	83	79	74	71	67	64	53	77
250	180	72	62	56	56	59	55	47	35	62
	880	80	71	67	64	65	61	54	43	69
	1540	85	77	73	69	68	64	60	48	73
	2200	91	83	79	74	71	67	64	53	77
280	220	73	64	58	58	60	57	49	37	64
	1120	82	73	68	67	66	63	56	45	71
	1960	86	78	74	70	69	65	61	49	74
	2800	92	84	80	75	72	68	65	54	78
315	280	75	65	59	59	63	58	50	38	66
	1400	83	74	70	67	68	65	58	47	72
	2450	87	80	76	72	71	66	63	50	76
	3500	93	85	81	76	73	69	66	55	79
355	355	77	67	61	61	65	60	52	50	68
	1800	85	76	72	69	70	66	59	48	74
	3150	90	82	78	74	73	69	65	53	78
	4500	94	86	82	77	74	70	67	56	80
400	455	79	69	63	63	66	61	53	41	69
	2320	86	77	73	70	71	67	60	49	75
	4060	90	82	78	74	73	69	65	53	78
	5800	94	86	82	77	74	70	67	56	80
500	710	78	67	60	60	63	60	53	41	66
	4200	88	79	75	72	73	69	62	51	77
	6300	92	84	80	76	75	71	67	55	80
	8500	96	88	84	79	76	72	69	58	82
630	1120	80	70	65	65	68	63	55	43	71
	6700	90	81	77	74	75	71	64	53	79
	10000	94	86	82	78	77	73	69	57	82
	13500	98	90	86	81	78	74	71	60	84

SERIE

RPM-V

DATOS TÉCNICOS



Nivel de potencia sonora L_{wa} (dB (A)) en el interior de la conducción

Ø 80

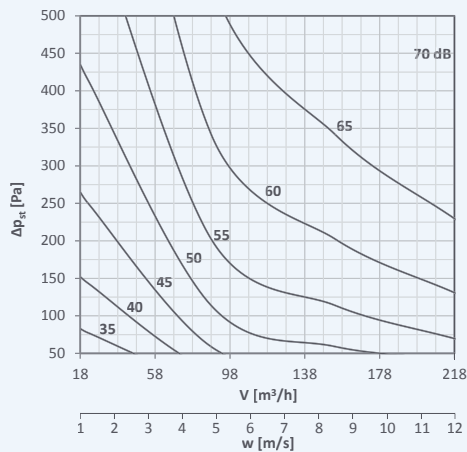

Ø 100

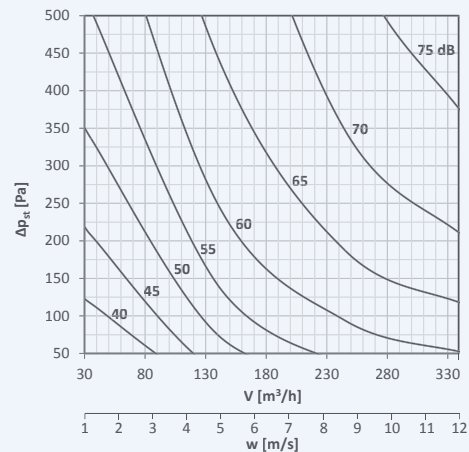

Ø 125

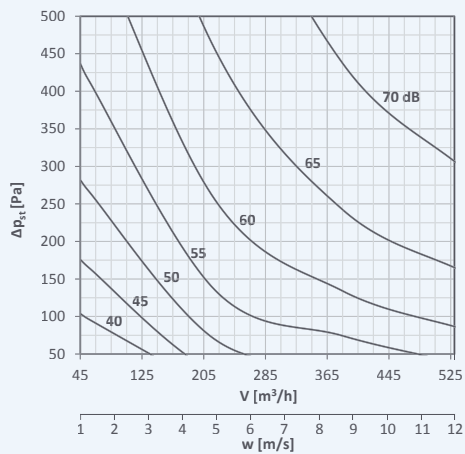

Ø 160

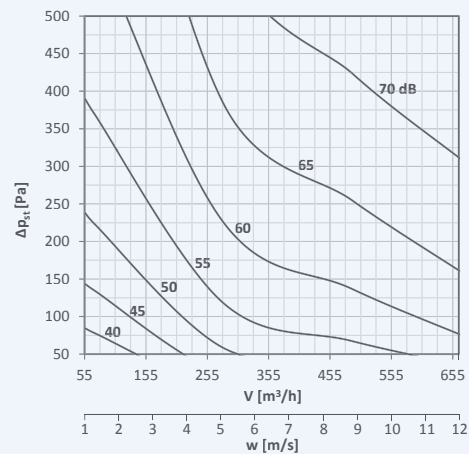

Ø 200

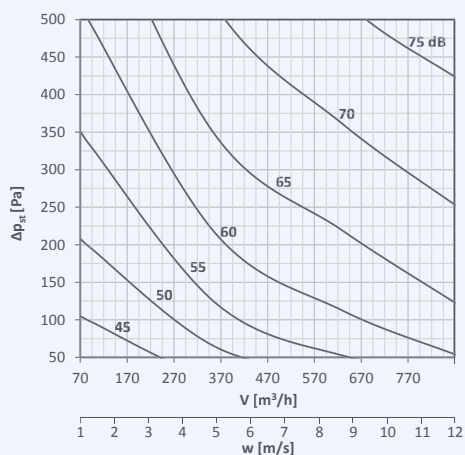

Ø 250

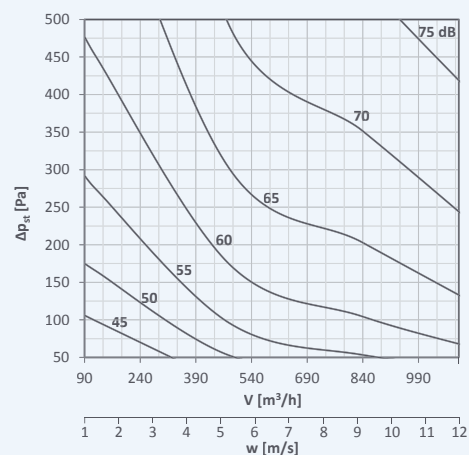

SERIE

RPM-V

DATOS TÉCNICOS



Nivel de potencia sonora L_{wa} (dB (A)) en el interior de la conducción

Ø 200

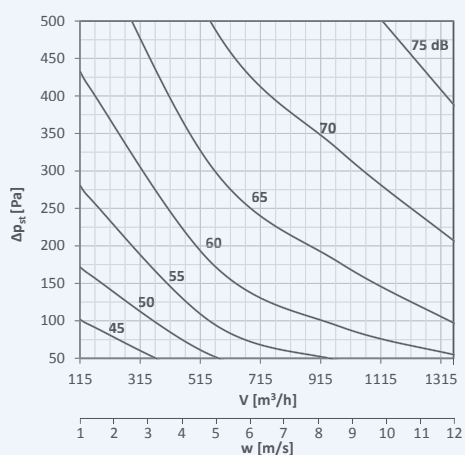

Ø 225

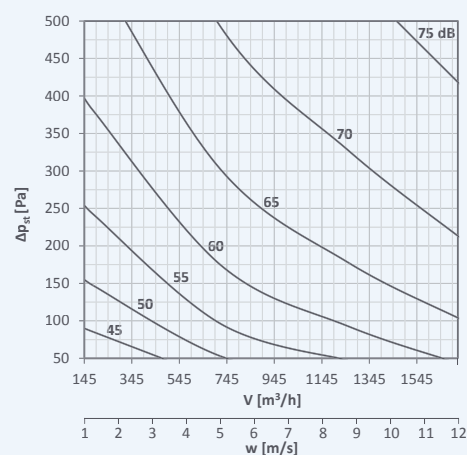

Ø 250

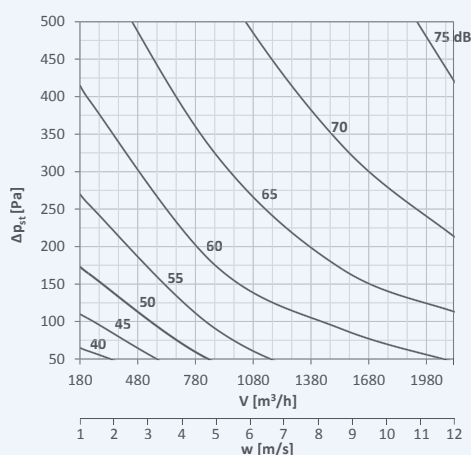

Ø 280

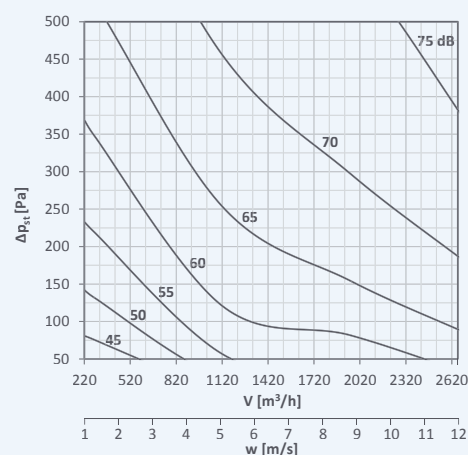

Ø 315

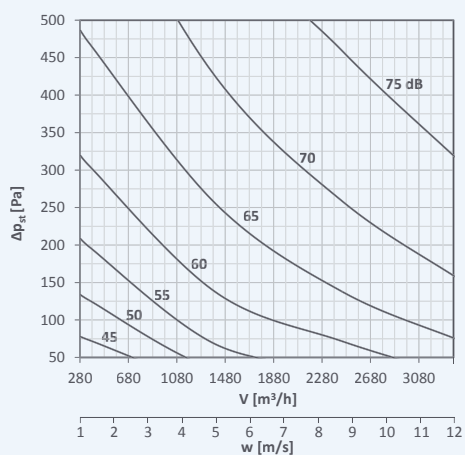

Ø 355

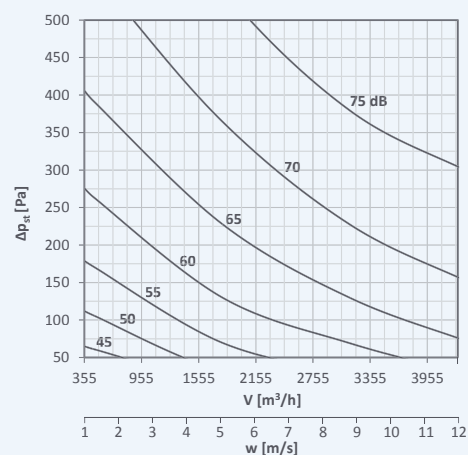

SERIE

RPM-V

DATOS TÉCNICOS



REGULACIÓN

Nivel de potencia sonora L_{wa} (dB (A)) en el interior de la conducción

Ø 400

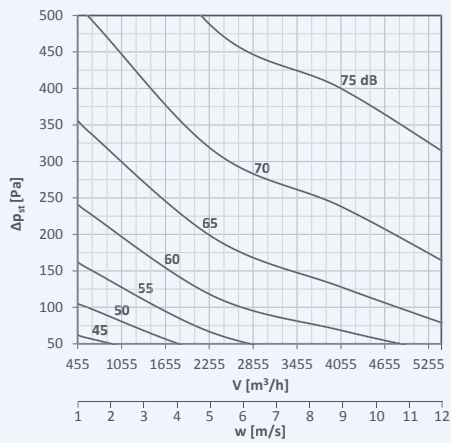

Ø 500

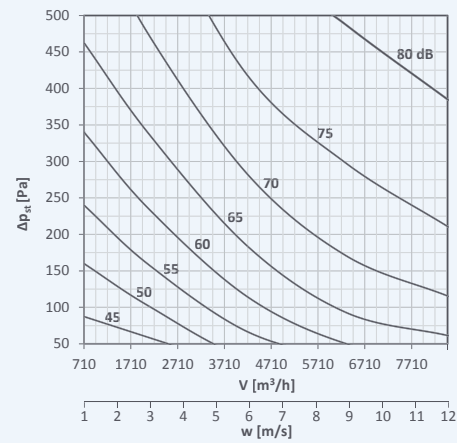

Ø 630

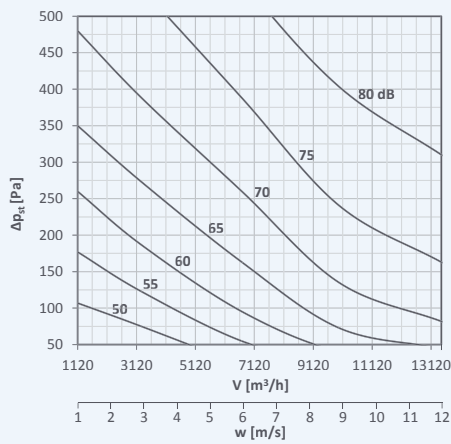

SERIE

RPM-V

DATOS TÉCNICOS



Nivel de potencia acústica radiada en el exterior de la tubería - sin aislamiento

El ruido radiado del controlador de volumen de aire se indica a continuación

V [m³h⁻¹] - volumen de flujo de aire
 ΔP_{st} [Pa] - presión diferencial

L_{WA} [dB(A)] - nivel total de potencia acústica
 corregido por el filtro A

Dimensión [mm]	V [m ³ /h]	L _{WA} [dB(A)]	L _{WA} [dB(A)]	L _{WA} [dB(A)]	L _{WA} [dB(A)]
		$\Delta P_{st}= 50$ Pa	$\Delta P_{st}= 100$ Pa	$\Delta P_{st}= 250$ Pa	$\Delta P_{st}= 500$ Pa
80	18	12	16	24	33
	88	24	29	38	47
	154	30	34	42	50
	220	35	39	47	54
100	30	14	18	27	37
	140	26	31	39	47
	245	33	38	45	52
	350	36	41	48	55
125	45	15	19	28	38
	220	27	33	41	49
	385	33	38	45	52
	550	37	42	49	56
140	55	18	23	31	39
	280	29	34	42	50
	490	34	39	46	53
	700	39	44	50	56
160	70	21	26	33	42
	360	30	35	43	51
	630	34	39	47	54
	900	39	44	51	57
180	90	21	25	33	42
	480	31	36	44	52
	840	35	40	48	56
	1200	40	45	52	59
200	115	22	27	34	43
	560	31	36	44	52
	980	35	40	48	55
	1400	41	45	52	58
225	145	23	28	38	46
	720	33	38	46	53
	1260	37	42	49	56
	1800	42	46	53	59
250	180	25	30	39	47
	880	36	40	47	53
	1540	40	44	51	57
	2200	44	48	54	60
280	220	28	33	43	51
	1120	37	42	50	56
	1960	42	46	54	60
	2800	45	50	57	63
315	280	30	34	44	53
	1400	39	44	52	59
	2450	44	48	56	62
	3500	47	51	59	65
355	355	29	34	44	54
	1800	39	44	52	60
	3150	44	49	56	63
	4500	48	53	60	66
400	455	30	36	46	54
	2320	38	44	53	61
	4060	44	49	57	64
	5800	50	54	61	67
500	710	31	36	47	55
	4200	45	50	59	66
	6300	51	56	64	70
	8400	55	60	67	73
630	1120	40	44	52	60
	6700	52	57	64	70
	10000	56	61	68	74
	13300	59	64	71	77

SERIE

RPM-V

DATOS TÉCNICOS



Nivel de potencia sonora L_{wa} (dB (A)) en el interior de la conducción - sin aislamiento

Ø 80

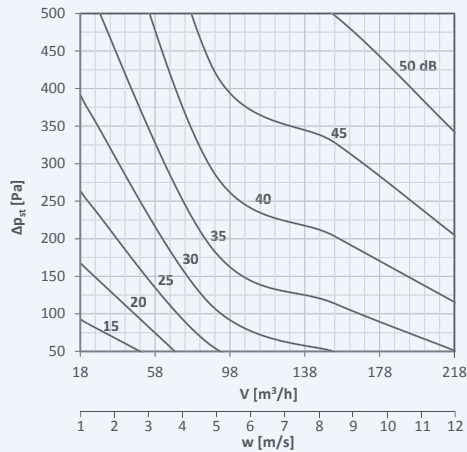

Ø 100

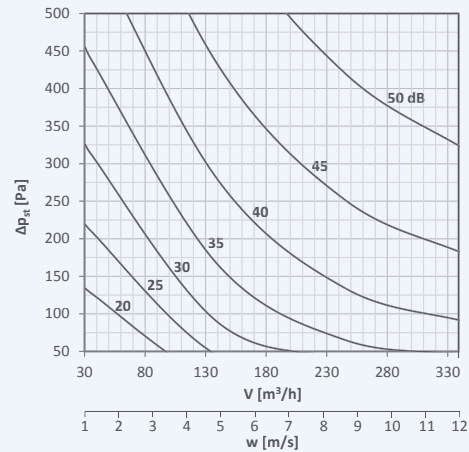

Ø 125

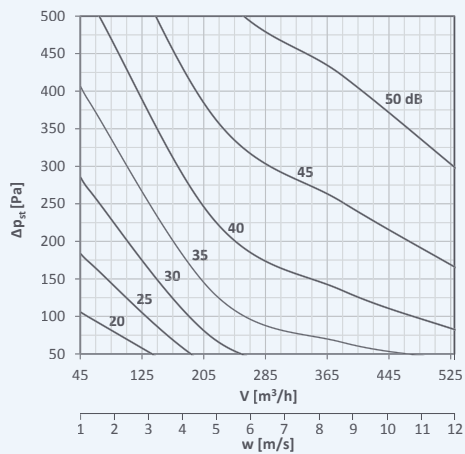

Ø 160

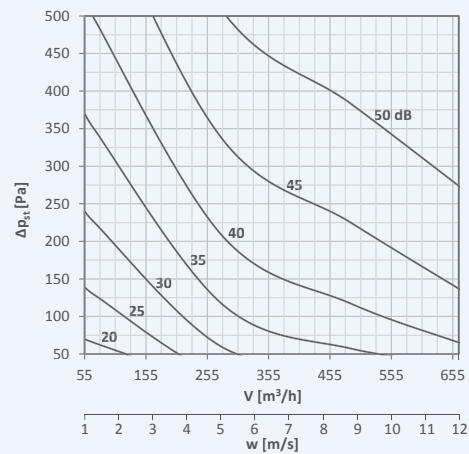

Ø 200

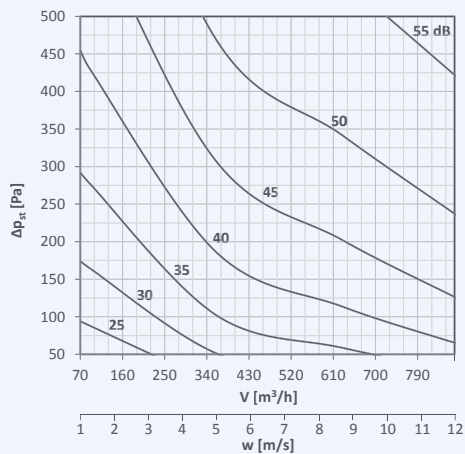

Ø 250

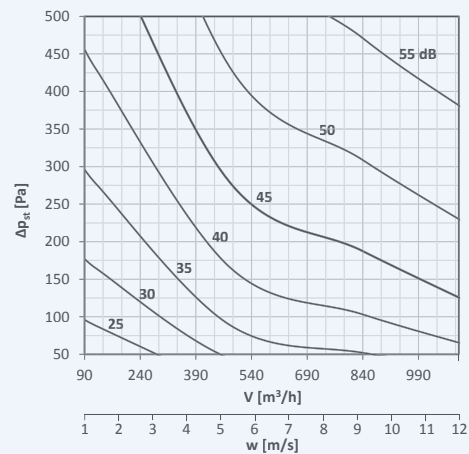

SERIE

RPM-V

DATOS TÉCNICOS



Nivel de potencia sonora L_{wa} (dB (A)) en el interior de la conducción - sin aislamiento

Ø 200

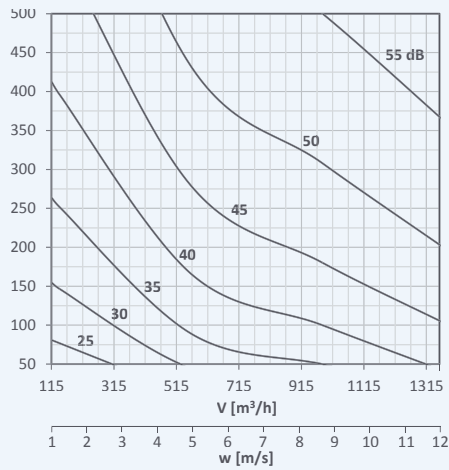

Ø 225

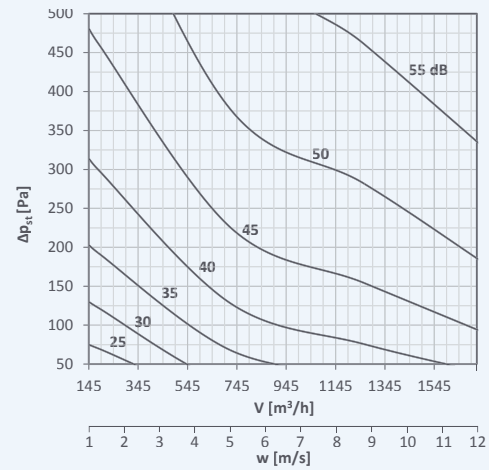

Ø 250

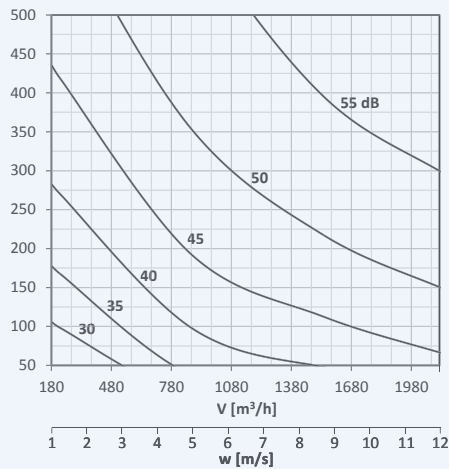

Ø 280

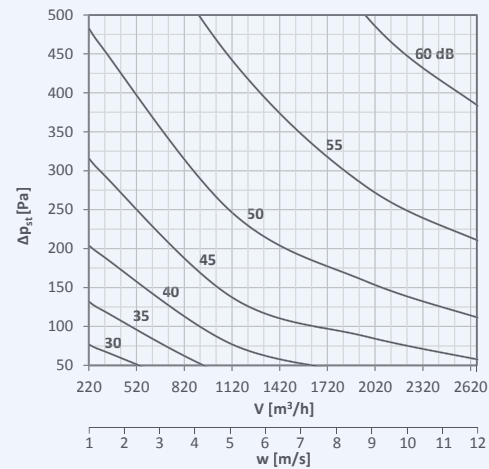

Ø 315

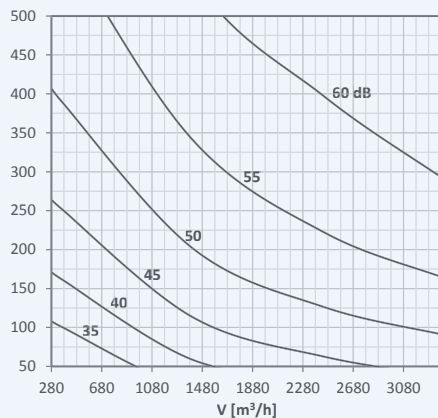

Ø 355

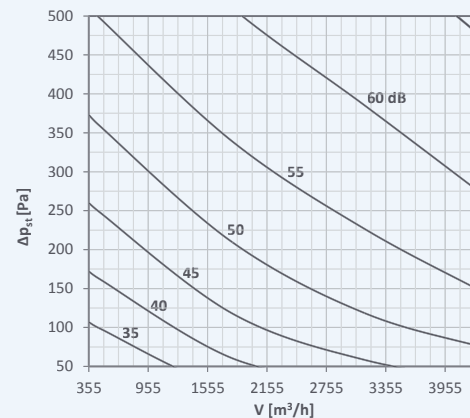

SERIE

RPM-V

DATOS TÉCNICOS



REGULACIÓN

Nivel de potencia sonora L_{wa} (dB (A)) en el interior de la conducción - sin aislamiento

Ø 400

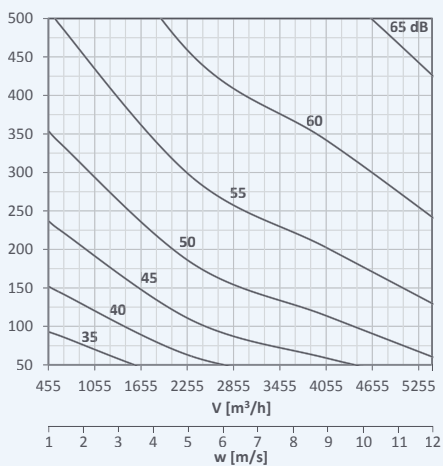

Ø 500

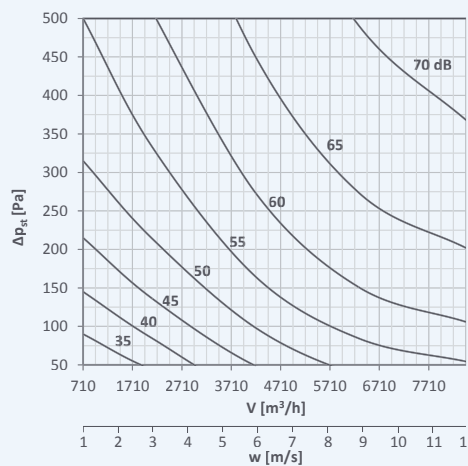

Ø 630

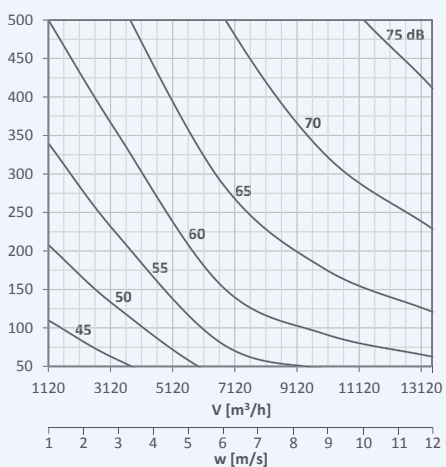

SERIE RPMC-V



COMPUERTA CAUDAL VARIABLE

Modelo **RPMC-V**. Los reguladores de volumen de aire están pensados para sistemas con un volumen de aire variable que se utiliza para la entrada o salida de aire. La cantidad de aire necesaria que se introduce en las distintas salas o zonas de trabajo es variable con respecto al tiempo y puede cambiarse según la necesidad momentánea cuando los controladores están instalados. La potencia total del sistema de aire acondicionado puede ser menor. Esta variable permiten un funcionamiento más económico de los sistemas de aire acondicionado y al mismo tiempo garantizan el bienestar individual en la configuración de los locales.

El controlador consiste en el cuerpo del controlador con un control de cuchillas y sondas de presión para determinar el flujo de aire. En el cuerpo del regulador se encuentra un regulador compacto para controlar las palas de control.

Características:

- Tipo de regulación: control del caudal de aire control de la presión en el conducto control de la presión en el local
- Tamaño nominal 200x100 ÷ 1000x1000
- Longitud L = 300 mm
- Estanqueidad según EN 1751 Clase de fuga externa de la carcasa C
- Fugas internas clase 3
- Volumen de flujo de aire 70 ÷ 26 000 m³/h (para 12m/s es un volumen de flujo de aire máximo de 43 000 m³/h*)
- Precisión ± 8 % para velocidad hasta 3 m/s y ± 5 % para velocidad superior.
- La velocidad del aire La configuración estándar está en el rango de min. 1 m/s a 7 m/s por Belimo.

Condiciones de trabajo:

- El funcionamiento correcto de los reguladores está garantizado en las siguientes condiciones a) velocidad máxima del flujo de aire 7 m/s b) presión máxima en el conducto 1000 Pa c) la circulación de aire en toda la sección del regulador debe estar asegurada como constante en toda la superficie
- Los reguladores están diseñados para zonas macroclimáticas con clima suave según la norma EN 60721-3-3.
- Los reguladores son adecuados para sistemas sin partículas abrasivas, químicas y adhesivas. La temperatura en el lugar de instalación puede oscilar entre 0°C y +50°C.
- Los reguladores se suministran sin aislamiento o con un diseño aislado. El grosor del aislamiento es de 40 mm.

Modelos:

RPMC-V.01 Para control con señal 0(2)...10 V o protocolo MP-BUS.

RPMC-V.02 Para control con la señal 0(2)...10 V o utilizando el protocolo Modbus RTU, BACnet o MP-BUS

Opcionales:

RPMC-V.75

RPMC-V.78

RPMC-V.91

RPMC-V.92

* ver descripción de modelos en tabla.

* Flujo de aire		solución compacta (sensor, controlador y actuador en una sola caja)		Dinámico	Analog MPBus (5 N.m, NMV-D3-MP 10 N.m, SMV-D3-MP 20 N.m)	LMV-D3-MP (5 N.m, NMV-D3-MP 10 N.m, SMV-D3-MP 20 N.m)	0...500Pa	.01
Flujo de aire		solución compacta (sensor, controlador y actuador en una sola caja)		Dinámico	MODBUS BACnet MPBus (5 N.m, NMV-D3-MOD 10 N.m, SMV-D3-MOD 20 N.m)	LMV-D3-MOD (5 N.m, NMV-D3-MOD 10 N.m, SMV-D3-MOD 20 N.m)	0...500Pa	.02
Presión	Presión	sensor, controller and actuador all in separate boxes		Estática	Analog MP-Bus (5 N.m., NM24A-VST 10 N.m, SM24A-VST 20 N.m)	Controlador VRU-M1-BAC (STP) + LM24A-VST (5 N.m., NM24A-VST 10 N.m, SM24A-VST 20 N.m)	0...600 Pa	.75
		sensor, controller and actuador all in separate boxes			ModBus (5 N.m., NM24A-VST 10 N.m, SM24A-VST 20 N.m)	Controlador VRU-M1-BAC (STP) + LM24A-VST (5 N.m., NM24A-VST 10 N.m, SM24A-VST 20 N.m)	0...600 Pa	.78
Presión en la sala	Presión en la sala	sensor, controller and actuador all in separate boxes		Estática	BACnet (5 N.m., NM24A-VST 10 N.m, SM24A-VST 20 N.m)	Controlador VRU-M1R-BAC (STP) + LM24A-VST (5 N.m., NM24A-VST 10 N.m, SM24A-VST 20 N.m)	-75...+75	.91
		sensor, controller and actuador all in separate boxes			ModBus BACnet (5 N.m., NM24A-VST 10 N.m, SM24A-VST 20 N.m)	Controlador VRU-M1R-BAC (STP) + LM24A-VST (5 N.m., NM24A-VST 10 N.m, SM24A-VST 20 N.m)	-75...+75	.92

SERIE

RPMC-V



Volumen de aire Belimo

Dimensiones AxB [mm]	Volumen de aire [m³/h]					
	Valores estándar*			Valores máximos		
	Mínimo (w ≈ 1m/s)	Máximo (w ≈ 7m/s)	V _{nom}	Mínimo (w ≈ 1m/s)	Máximo (w ≈ 12m/s)	V _{nom}
200x100	70	500	500	70	900	900
x200	145	1000	1000	145	1800	1800
300x100	110	750	750	110	1300	1300
x200	215	1500	1500	215	2600	2600
x300	325	2300	2300	325	3900	3900
400x100	145	1000	1000	145	1800	1800
x200	290	2000	2000	290	3500	3500
x300	430	3100	3100	430	5200	5200
x400	580	4100	4100	580	7000	7000
500x100	180	1250	1250	180	2200	2200
x200	360	2500	2500	360	4400	4400
x300	540	3800	3800	540	6500	6500
x400	720	5100	5100	720	8700	8700
x500	900	6400	6400	900	11000	11000
600x100	215	1500	1500	215	2600	2600
x200	430	3100	3100	430	5200	5200
x300	650	4600	4600	650	7800	7800
x400	865	6200	6200	865	10500	10500
x500	1080	7700	7700	1080	13000	13000
x600	1300	9200	9200	1300	16000	16000
700x200	500	3600	3600	500	6000	6000
x300	800	5400	5400	800	9000	9000
x400	1000	7200	7200	1000	12000	12000
x500	1250	9000	9000	1250	15000	15000
800x200	580	4100	4100	580	7000	7000
x300	870	6200	6200	870	10500	10500
x400	1150	8200	8200	1150	14000	14000
x500	1450	10500	10500	1450	17500	17500
x600	1730	12500	12500	1730	21000	21000
x800	2300	16500	16500	2300	28000	28000
900x300	980	6900	6900	980	12000	12000
x400	1300	9200	9200	1300	16000	16000
x500	1620	12000	12000	1620	20000	20000
1000x300	1080	7700	7700	1080	13000	13000
x400	1440	10500	10500	1440	17500	17500
x500	1800	13000	13000	1800	22000	22000
x600	2160	15500	15500	2160	26000	26000
x800	2880	21000	21000	2880	35000	35000
x1000	3600	26000	26000	3600	43000	43000

*Configuración por defecto del controlador

SERIE RPMC-V

DATOS TÉCNICOS



Determinación del volumen de aire efectivo

El valor del volumen de aire se determina mediante el cálculo a partir del valor medido U_5

Ejemplo: Modo de funcionamiento 2...10V

$$\dot{V} = \frac{U_5 - 2,0}{8} \cdot \dot{V}_{nom}$$

Ejemplo: Modo de funcionamiento 0...10V

$$\dot{V} = \frac{U_5 \cdot \dot{V}_{nom}}{10}$$

Búsqueda para: volumen de aire efectivo

Tensión medida en U_5 : 3,5 V

$$\dot{V}_{nom} = 2800 \text{ m}^3 \cdot \text{h}^{-1}$$

$$\dot{V} = \frac{3,5 - 2,0}{8} \cdot 2800 = 525$$

El volumen de aire actual es 525 $\text{m}^3 \cdot \text{h}^{-1}$.

Búsqueda para: volumen de aire efectivo

Tensión medida en U_5 : 3,5 V

$$\dot{V}_{nom} = 2200 \text{ m}^3 \cdot \text{h}^{-1}$$

$$\dot{V} = \frac{3,5 \cdot 2200}{10} = 770$$

El volumen de aire actual es 770 $\text{m}^3 \cdot \text{h}^{-1}$.

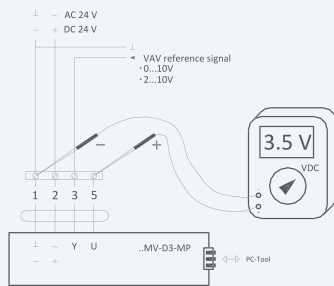

Pérdida de presión

Determinación de pérdida de presión usando diagrama $\rho=1,2\text{kg}\cdot\text{m}^3$

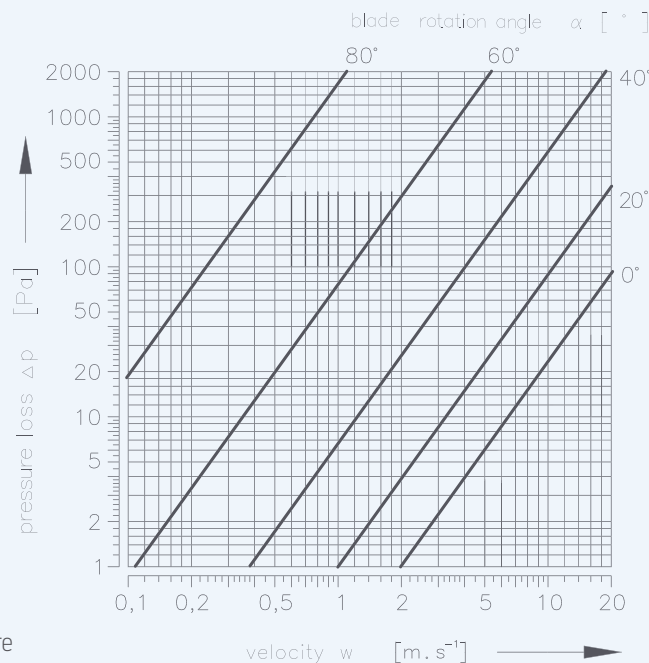

Ruido regenerado por el aire

El ruido producido por el flujo del regulador de volumen de aire se indica en las siguientes tablas

V [$\text{m}^3 \cdot \text{h}^{-1}$] - volumen de flujo de aire

Δst [Pa] - presión diferencial

L_w [dB/Okt.] - nivel de potencia acústica en la banda de octava

L_{WA} [dB(A)] - nivel total de potencia acústica

corregido por el filtro A

f_m [Hz] - frecuencias medias en las bandas de octava

SERIE

RPMC-V

DATOS TÉCNICOS



Nivel de potencia sonora en el interior de la tubería con una diferencia de presión de 50 Pa

Dimensión [mm]	V [m³/h]	$\Delta P_{st} = 50 \text{ Pa}$								$L_{WA} \text{ [dB(A)]}$
		$L_w \text{ [dB/Okt]}$								
		$f_m \text{ [Hz]}$								
		63	125	250	500	1000	2000	4000	8000	
200x100	90	44	43	39	39	39	40	43	37	47
	360	44	43	41	40	34	41	43	38	48
	630	45	47	48	47	47	45	47	39	52
	900	51	50	51	52	52	51	50	44	57
200x200	180	47	47	42	42	42	43	43	40	50
	720	46	45	43	42	41	43	43	40	50
	1260	46	48	49	48	48	46	46	40	53
	1800	51	50	51	52	52	51	51	43	57
300x100	130	44	43	39	39	39	40	40	38	47
	520	45	45	43	42	42	43	43	40	49
	910	45	47	48	47	47	45	45	40	52
	1300	50	49	50	51	51	50	50	43	56
300x200	260	46	45	41	41	42	42	42	39	49
	1040	46	45	44	43	43	44	44	41	50
	1820	48	50	51	50	50	48	48	42	58
	2600	52	51	52	53	53	52	52	44	58
300x300	390	46	45	41	41	41	42	42	39	49
	1560	46	45	43	42	41	43	43	40	49
	2730	47	49	50	49	51	47	47	41	54
	3900	53	52	53	54	54	53	53	45	59
400x100	180	45	44	40	40	40	41	41	38	48
	720	46	45	43	42	41	43	43	40	49
	1260	46	48	49	48	48	46	46	40	53
	1800	52	51	52	53	53	52	52	44	58
400x200	350	46	45	41	41	41	42	42	39	49
	1400	47	46	44	43	42	44	44	41	50
	2450	48	50	51	50	50	48	48	42	55
	3500	52	51	52	53	53	52	52	44	58
400x300	520	45	44	40	46	40	41	41	38	47
	2080	47	46	44	43	42	44	44	41	51
	3640	48	50	51	50	50	48	48	42	55
	5200	54	53	54	55	55	54	54	46	60
400x400	700	50	49	45	45	45	46	46	43	53
	2800	52	51	49	48	47	49	49	46	56
	4900	53	55	56	55	55	53	53	47	60
	7000	60	59	61	61	61	60	60	52	66
500x100	220	47	46	42	42	42	43	43	40	50
	880	47	46	44	43	42	44	44	51	51
	1540	47	49	60	49	49	47	47	41	54
	2200	52	51	52	53	53	52	52	44	58
500x200	440	45	44	41	41	41	42	42	39	48
	1760	47	46	44	43	42	44	44	41	51
	3080	48	50	51	50	50	48	48	42	55
	4400	54	53	54	55	55	54	54	46	60
500x300	650	54	44	40	40	40	41	41	38	48
	2600	46	45	43	42	42	43	43	40	50
	4550	47	48	48	47	47	47	47	42	53
	6500	54	53	53	53	53	53	53	47	59
500x400	870	46	45	42	41	41	42	42	39	49
	3480	47	46	44	43	42	44	44	41	51
	6090	47	49	50	49	49	47	47	41	54
	8700	55	54	55	56	56	55	55	47	61

SERIE RPMC-V

DATOS TÉCNICOS



REGULACIÓN

Nivel de potencia sonora en el interior de la tubería con una diferencia de presión de 50 Pa

		$\Delta P_{st} = 50 \text{ Pa}$								
Dimensión [mm]	V [m³/h]	L_w [dB/Okt]								L_{wA} [dB(A)]
		f_m [Hz]								
		63	125	250	500	1000	2000	4000	8000	
500x500	1100	47	46	42	42	42	43	43	40	50
	4400	49	48	46	45	44	46	46	43	53
	7700	50	52	51	51	51	50	50	45	57
	11000	58	58	57	57	57	57	57	51	63
600x100	260	46	45	41	41	41	42	42	39	49
	1040	46	45	44	43	42	44	44	41	50
	1820	48	50	51	50	50	48	48	42	55
	2600	52	51	52	53	53	52	52	44	58
600x200	520	46	45	41	41	41	42	42	39	49
	2080	47	47	45	44	43	45	45	42	51
	3640	48	50	52	51	51	48	48	41	55
	5200	54	53	54	55	55	55	54	46	60
600x300	780	46	45	42	42	42	43	43	40	49
	3120	48	47	46	45	44	46	46	43	52
	5460	49	51	52	51	51	49	49	43	56
	7800	55	54	55	56	56	55	55	47	61
600x400	1050	46	45	41	41	41	42	42	39	49
	4200	48	47	45	44	43	45	45	42	52
	7350	48	50	51	50	50	48	48	43	55
	10500	55	54	55	56	56	55	55	47	61
600x500	1300	50	49	45	45	45	46	46	43	53
	5200	54	53	51	39	49	51	51	48	58
	9100	54	56	57	56	56	54	54	48	60
	13000	61	60	61	62	62	61	61	53	67
600x600	160	51	50	46	46	46	47	47	44	54
	5440	53	52	50	49	48	50	50	47	57
	10720	58	58	58	57	57	55	55	49	62
	16000	62	61	62	63	62	62	62	54	68
700x200	600	45	44	40	40	40	41	41	38	48
	2400	48	47	46	45	44	46	46	43	52
	4200	49	51	52	51	51	49	49	43	56
	6000	55	54	55	56	56	55	55	47	60
700x300	900	46	45	41	41	41	42	42	39	49
	3600	48	47	47	44	43	45	45	42	52
	6300	49	50	51	50	50	49	49	43	55
	9000	55	54	55	56	56	55	55	47	61
700x400	1200	46	45	41	41	40	42	42	39	49
	4800	49	48	47	46	44	47	47	44	53
	8400	49	51	52	51	51	49	49	44	56
	12000	57	56	57	58	58	57	57	49	62
700x500	1500	51	50	46	46	45	47	47	44	54
	6000	55	54	52	51	49	52	52	49	59
	10500	55	57	58	57	57	55	55	49	62
	15000	63	62	63	64	64	63	63	55	69
800x200	700	49	48	44	44	44	45	45	42	52
	2800	52	51	49	48	46	49	49	46	56
	4900	53	55	55	54	54	53	53	47	60
	7000	59	58	58	58	58	58	58	51	64
800x300	1050	46	45	41	41	41	42	42	39	49
	4200	48	48	46	45	43	46	46	43	52
	7350	48	50	52	51	50	48	48	42	55
	10500	55	54	55	56	56	56	56	46	61

SERIE

RPMC-V

DATOS TÉCNICOS



Nivel de potencia sonora en el interior de la tubería con una diferencia de presión de 50 Pa

		$\Delta P_{st} = 50 \text{ Pa}$								
Dimensión [mm]	V [m³/h]	L_w [dB/Okt]								L_{wA} [dB(A)]
		f_m [Hz]								
		63	125	250	500	1000	2000	4000	8000	
800x400	1400	46	45	41	41	40	42	42	39	49
	5600	49	48	46	45	43	46	46	43	53
	9800	50	52	53	52	52	50	50	45	57
	14000	57	56	57	58	57	57	57	49	63
800x500	1750	51	50	46	46	46	47	47	44	54
	7000	55	54	52	51	50	52	52	49	59
	12250	56	58	59	58	58	56	56	50	62
	17500	63	62	63	64	64	63	63	55	69
800x600	2100	51	50	47	47	47	48	48	45	54
	8400	56	55	53	52	51	53	53	50	60
	14700	56	58	59	58	58	56	56	50	63
	21000	64	63	64	65	65	64	64	56	70
800x800	2800	52	51	47	47	47	48	48	45	55
	11200	57	56	54	53	52	54	54	51	60
	19600	58	57	60	59	59	58	58	52	64
	28000	66	65	66	67	67	66	66	58	72
900x300	1200	51	50	46	46	46	47	47	44	54
	4800	54	53	51	50	49	51	51	48	58
	8400	55	57	57	57	57	55	55	49	61
	12000	61	60	61	62	62	61	61	53	67
900x400	1600	52	51	47	47	47	48	48	45	55
	6400	55	54	52	51	50	52	52	49	59
	11200	56	57	58	57	57	56	56	50	62
	16000	62	61	62	63	63	62	62	54	68
900x500	2000	52	51	47	47	47	48	48	45	55
	8000	56	55	53	52	51	53	53	50	60
	14000	57	58	59	58	58	57	57	51	63
	20000	64	63	64	65	65	64	64	56	70
1000x300	1300	51	50	46	46	46	47	47	44	54
	5200	54	53	51	50	49	51	51	48	58
	9100	54	56	57	56	56	54	54	48	61
	13000	62	61	62	63	63	62	62	54	68
1000x400	1750	52	51	47	47	47	48	48	45	55
	7000	54	53	51	50	49	51	51	48	58
	12250	56	58	59	58	58	56	56	50	63
	17500	63	62	63	64	64	63	63	55	69
1000x500	2200	50	49	45	45	45	46	46	43	53
	8800	56	55	53	52	51	53	53	50	60
	15400	57	59	60	59	59	57	57	51	63
	22000	64	63	64	65	65	64	64	56	70
1000x600	2600	53	52	48	48	48	49	49	46	56
	10400	57	56	54	53	52	54	54	51	60
	18200	57	59	60	59	59	57	57	51	63
	26000	65	64	65	66	66	65	65	57	71
1000x800	3500	54	53	49	49	49	50	50	47	57
	14000	58	57	55	54	53	55	55	52	61
	24500	59	60	61	60	60	59	59	53	65
	35000	67	66	67	68	68	67	67	59	73
1000x1000	4300	54	53	49	49	49	50	50	47	57
	17200	59	58	56	55	54	56	56	53	62
	30100	59	61	62	61	61	59	59	53	66
	43000	67	66	67	68	68	67	67	59	73

SERIE RPMC-V

DATOS TÉCNICOS



Nivel de potencia sonora en el interior de la tubería con una diferencia de presión de 100 Pa

		$\Delta P_{st} = 100 \text{ Pa}$								
Dimensión [mm]	V [m³/h]	L_w [dB/Okt]								L_{WA} [dB(A)]
		f_m [Hz]								
		63	125	250	500	1000	2000	4000	8000	
200x100	90	48	47	43	43	43	44	47	41	51
	360	49	48	46	45	44	46	48	43	53
	630	50	52	53	52	52	50	52	44	57
	900	56	55	56	57	57	56	55	48	62
200x200	180	50	49	45	45	45	46	46	43	53
	720	51	50	48	47	46	48	48	45	55
	1260	51	53	54	53	53	51	51	45	58
	1800	56	55	56	57	57	56	56	48	62
300x100	130	49	48	44	44	44	45	45	42	52
	520	51	50	48	47	46	48	48	45	55
	910	51	53	54	53	53	51	51	45	58
	1300	56	55	56	57	57	56	56	48	62
300x200	260	50	49	45	45	45	46	46	43	53
	1040	52	51	49	48	47	49	49	46	56
	1820	53	55	56	55	55	53	53	47	60
	2600	57	56	57	58	58	57	57	49	63
300x300	390	50	49	45	45	45	46	46	43	53
	1560	51	50	48	47	46	48	48	45	55
	2730	52	54	55	54	54	52	52	46	59
	3900	58	57	58	59	59	58	58	50	64
400x100	180	49	48	44	44	44	45	45	42	52
	720	51	50	48	47	46	48	48	45	55
	1260	51	53	54	53	53	51	51	45	58
	1800	56	55	56	57	57	56	56	48	62
400x200	350	50	49	45	45	45	46	46	43	53
	1400	52	51	49	48	47	49	49	46	56
	2450	53	55	56	55	55	53	53	47	60
	3500	59	58	59	60	60	59	59	51	65
400x300	520	50	49	45	45	45	46	46	43	53
	2080	53	52	50	49	48	50	50	47	57
	3640	53	55	56	55	55	53	53	47	60
	5200	59	58	59	60	60	59	59	51	65
400x400	700	55	54	50	50	50	51	51	48	58
	2800	58	57	55	54	53	55	55	52	62
	4900	59	61	62	61	61	59	59	53	66
	7000	65	64	65	66	66	65	65	57	71
500x100	220	49	48	44	44	44	45	45	42	52
	880	51	50	48	47	46	48	48	45	55
	1540	51	53	54	53	53	51	51	45	58
	2200	56	55	56	57	57	56	56	48	62
500x200	440	49	48	44	44	44	45	45	42	52
	1760	52	51	49	48	47	49	49	46	56
	3080	53	55	56	55	55	53	53	47	60
	4400	59	58	59	60	60	59	59	51	65
500x300	650	49	48	44	44	44	45	45	42	52
	2600	52	51	49	48	47	49	49	46	56
	4550	52	54	55	54	54	52	52	46	59
	6500	59	58	59	60	60	59	59	51	65
500x400	870	51	50	46	46	46	47	47	44	54
	3480	53	52	50	49	48	50	50	47	57
	6090	53	55	56	55	55	53	53	47	60
	8700	60	59	60	61	61	60	60	52	66

SERIE

RPMC-V

DATOS TÉCNICOS



Nivel de potencia sonora en el interior de la tubería con una diferencia de presión de 100 Pa

$\Delta P_{st} = 100 \text{ Pa}$										
Dimensión [mm]	V [m³/h]	L_w [dB/Okt]								L_{WA} [dB(A)]
		f_m [Hz]								
		63	125	250	500	1000	2000	4000	8000	
500x500	1100	51	50	46	46	46	47	47	44	54
	4400	54	53	51	50	49	51	51	48	58
	7700	55	57	58	57	57	55	55	49	62
	11000	63	62	63	64	64	63	63	55	69
600x100	260	50	49	45	45	45	46	46	43	53
	1040	52	51	49	48	47	49	49	46	56
	1820	53	55	56	55	55	53	53	47	60
	2600	57	56	57	58	58	57	57	49	63
600x200	520	50	49	45	45	45	46	46	43	53
	2080	53	52	50	49	48	50	50	47	57
	3640	53	55	56	55	55	53	53	47	60
	5200	59	58	59	60	60	59	59	51	65
600x300	780	51	50	46	46	46	47	47	44	54
	3120	54	53	51	50	49	51	51	48	58
	5460	54	56	57	56	56	54	54	48	61
	7800	61	60	61	62	62	61	61	53	67
600x400	1050	51	50	46	46	46	47	47	44	54
	4200	54	53	51	50	49	51	51	48	58
	7350	54	56	57	56	56	54	54	48	61
	10500	61	60	61	62	62	61	61	53	67
600x500	1300	55	54	50	50	50	51	51	48	58
	5200	59	58	56	55	54	56	56	53	63
	9100	59	61	62	61	61	59	59	53	66
	13000	67	66	67	68	68	67	67	59	73
600x600	160	56	55	51	51	51	52	52	49	59
	5440	59	58	56	55	54	56	56	53	63
	10720	60	62	63	62	62	60	60	54	67
	16000	68	67	68	69	69	68	68	60	74
700x200	600	50	49	45	45	45	46	46	43	53
	2400	54	53	51	50	49	51	51	48	58
	4200	54	56	57	56	56	54	54	48	61
	6000	60	59	60	61	61	60	60	52	66
700x300	900	51	50	46	46	46	47	47	44	54
	3600	53	52	50	49	48	50	50	47	57
	6300	54	56	57	56	56	54	54	48	61
	9000	60	59	60	61	61	60	60	52	66
700x400	1200	51	50	46	46	46	47	47	44	54
	4800	55	54	52	51	50	52	52	49	59
	8400	55	57	58	57	57	55	55	49	62
	12000	62	61	62	63	63	62	62	54	68
700x500	1500	56	55	51	51	51	52	52	49	59
	6000	60	59	57	56	55	57	57	54	64
	10500	60	62	63	62	62	60	60	54	67
	15000	68	67	68	69	69	68	68	60	74
800x200	700	55	54	50	50	50	51	51	48	58
	2800	58	57	55	54	53	55	55	52	62
	4900	59	61	62	61	61	59	59	53	66
	7000	65	64	65	66	66	65	65	57	71
800x300	1050	51	50	46	46	46	47	47	44	54
	4200	54	53	51	50	49	51	51	48	58
	7350	54	56	57	56	56	54	54	48	61
	10500	61	60	61	62	62	61	61	53	67

SERIE RPMC-V

DATOS TÉCNICOS



Nivel de potencia sonora en el interior de la tubería con una diferencia de presión de 100 Pa

		$\Delta P_{st} = 100 \text{ Pa}$								
Dimensión [mm]	V [m³/h]	L_w [dB(Okt)]								L_{WA} [dB(A)]
		f_m [Hz]								
		63	125	250	500	1000	2000	4000	8000	
800x400	1400	51	50	46	46	46	47	47	44	54
	5600	55	54	52	51	50	52	52	49	59
	9800	55	57	58	57	57	55	55	49	62
	14000	63	62	63	64	64	63	63	55	69
800x500	1750	56	55	51	51	51	52	52	49	59
	7000	60	59	57	56	55	57	57	54	64
	12250	61	63	64	63	63	61	61	55	68
	17500	69	68	69	70	70	69	69	61	75
800x600	2100	57	56	52	52	52	53	53	50	60
	8400	61	60	58	57	56	58	58	55	65
	14700	62	64	65	64	64	62	62	56	69
	21000	70	69	70	71	71	70	70	62	76
800x800	2800	58	57	53	53	53	54	54	51	61
	11200	62	61	59	58	57	59	59	56	66
	19600	63	65	66	65	65	63	63	57	70
	28000	72	71	72	73	73	72	72	64	78
900x300	1200	56	55	51	51	51	52	52	49	59
	4800	59	58	56	55	54	56	56	53	63
	8400	60	62	63	62	62	60	60	54	67
	12000	67	66	67	68	68	67	67	59	73
900x400	1600	57	56	52	52	52	53	53	50	60
	6400	60	59	57	56	55	57	57	54	64
	11200	61	63	64	63	63	61	61	55	68
	16000	68	67	68	69	69	68	68	60	74
900x500	2000	57	56	52	52	52	53	53	50	60
	8000	61	60	58	57	56	58	58	55	65
	14000	62	64	65	64	64	62	62	56	69
	20000	70	69	70	71	71	70	70	62	76
1000x300	1300	56	55	51	51	51	52	52	49	59
	5200	59	58	56	55	54	56	56	53	63
	9100	59	61	62	61	61	59	59	53	66
	13000	67	66	67	68	68	67	67	59	73
1000x400	1750	57	56	52	52	52	53	53	50	60
	7000	60	59	57	56	55	57	57	54	64
	12250	61	63	64	63	63	61	61	55	68
	17500	69	68	69	70	70	69	69	61	75
1000x500	2200	57	56	52	52	52	53	53	50	60
	8800	61	60	58	57	56	58	58	55	65
	15400	62	64	65	64	64	62	62	56	69
	22000	70	69	70	71	71	70	70	62	76
1000x600	2600	58	57	53	53	53	54	54	51	61
	10400	62	61	59	58	57	59	59	56	66
	18200	62	64	65	64	64	62	62	56	69
	26000	71	70	71	72	72	71	71	63	77
1000x800	3500	59	58	54	54	54	55	55	52	62
	14000	63	62	60	59	58	60	60	57	67
	24500	64	66	67	66	66	64	64	58	71
	35000	73	72	73	74	74	73	73	65	79
1000x1000	4300	59	58	54	54	54	55	55	52	62
	17200	64	63	61	60	59	61	61	58	68
	30100	65	67	68	67	67	65	65	59	72
	43000	73	72	73	74	74	73	73	65	79

SERIE

RPMC-V

DATOS TÉCNICOS



Nivel de potencia sonora en el interior de la tubería con una diferencia de presión de 250 Pa

		$\Delta P_{st} = 250 \text{ Pa}$								
Dimensión [mm]	V [m³/h]	L_w [dB/Okt]								L_{wA} [dB(A)]
		f_m [Hz]								
		63	125	250	500	1000	2000	4000	8000	
200x100	90	54	53	49	49	49	50	53	47	57
	360	58	57	55	54	53	55	57	52	62
	630	58	60	61	60	60	58	60	52	65
	900	65	64	65	66	66	65	64	57	71
200x200	180	58	57	53	53	53	54	54	51	61
	720	60	59	57	56	55	57	57	54	64
	1260	59	61	62	61	61	59	59	53	66
	1800	64	63	64	65	65	64	64	56	70
300x100	130	54	53	49	49	49	50	50	47	57
	520	58	57	55	54	53	55	55	52	62
	910	58	60	61	60	60	58	58	52	65
	1300	62	61	62	63	63	62	62	54	68
300x200	260	57	56	52	52	52	54	53	50	60
	1040	59	58	56	55	54	56	56	53	63
	1820	60	62	63	62	62	60	60	54	67
	2600	65	64	65	66	66	65	65	57	71
300x300	390	58	57	53	53	53	54	54	51	61
	1560	60	59	57	56	55	57	57	54	64
	2730	61	63	64	63	63	61	61	55	68
	3900	66	65	66	67	67	66	66	58	72
400x100	180	57	56	52	52	52	53	53	50	60
	720	59	58	56	55	54	56	56	53	63
	1260	59	61	62	61	61	59	59	53	66
	1800	66	65	66	67	67	66	66	58	72
400x200	350	58	57	53	53	53	54	54	51	61
	1400	60	59	57	56	55	57	57	54	64
	2450	61	63	64	63	63	61	61	55	68
	3500	65	64	65	66	66	65	65	57	71
400x300	520	58	57	53	53	53	54	54	51	61
	2080	61	60	58	57	56	58	58	55	65
	3640	62	64	65	64	64	62	62	56	69
	5200	67	66	67	68	68	67	67	59	73
400x400	700	59	58	54	54	54	55	55	52	62
	2800	62	61	59	58	57	59	59	56	66
	4900	62	64	65	64	64	62	62	56	69
	7000	68	67	68	69	69	68	68	60	74
500x100	220	57	56	52	52	52	53	53	50	60
	880	60	59	57	56	55	57	57	54	64
	1540	60	62	63	62	62	60	60	54	67
	2200	63	62	63	64	64	63	63	55	69
500x200	440	58	57	53	53	53	54	54	51	61
	1760	61	60	58	57	56	58	58	55	65
	3080	62	64	65	64	64	62	62	56	69
	4400	65	64	65	66	66	65	65	57	71
500x300	650	58	57	53	53	53	54	54	51	61
	2600	61	60	58	57	57	58	58	55	65
	4550	61	63	61	60	60	61	61	58	68
	6500	65	66	64	63	63	64	64	61	71
500x400	870	60	58	56	55	55	56	56	53	63
	3480	62	61	59	58	57	59	59	56	66
	6090	62	64	65	64	64	62	62	56	69
	8700	68	67	68	69	69	68	68	60	74

SERIE RPMC-V

DATOS TÉCNICOS



REGULACIÓN

Nivel de potencia sonora en el interior de la tubería con una diferencia de presión de 250 Pa

		$\Delta P_{st} = 250 \text{ Pa}$								
Dimensión [mm]	V [m³/h]	L_w [dB/Okt]								L_{wA} [dB(A)]
		f_m [Hz]								
		63	125	250	500	1000	2000	4000	8000	
500x500	1100	64	63	59	59	59	60	60	57	67
	4400	66	66	62	62	62	63	63	60	70
	7700	66	69	65	65	65	66	66	63	73
	11000	71	73	69	69	69	70	70	67	77
600x100	260	57	56	52	52	52	53	53	50	60
	1040	59	58	56	55	54	56	56	53	63
	1820	60	62	63	62	62	60	60	54	67
	2600	64	63	64	65	65	64	64	56	70
600x200	520	59	58	54	54	54	55	55	52	62
	2080	61	60	58	57	56	58	58	55	65
	3640	62	64	65	64	64	62	62	56	69
	5200	66	65	66	67	67	66	66	58	72
600x300	780	59	58	54	54	54	55	55	52	62
	3120	62	61	59	58	57	59	59	56	66
	5460	63	65	66	65	65	63	63	57	70
	7800	67	66	67	68	68	67	67	59	73
600x400	1050	60	59	55	55	55	56	56	53	63
	4200	63	62	60	59	58	60	60	57	67
	7350	63	65	66	65	65	63	63	57	70
	10500	68	67	68	69	69	68	68	60	74
600x500	1300	64	63	59	59	59	60	60	57	67
	5200	67	66	64	63	62	64	64	61	71
	9100	66	68	69	68	68	66	66	60	73
	13000	71	70	71	72	72	71	71	63	77
600x600	160	63	62	58	58	58	59	59	56	66
	5440	66	65	63	62	61	63	63	60	70
	10720	67	69	70	69	69	67	67	61	74
	16000	72	71	72	73	73	72	72	64	78
700x200	600	59	58	54	54	54	55	55	52	62
	2400	62	61	59	58	57	59	59	56	66
	4200	62	64	65	64	64	62	62	56	69
	6000	66	65	66	67	67	66	66	58	72
700x300	900	60	59	55	55	55	56	56	53	63
	3600	63	62	60	59	58	60	60	57	67
	6300	63	65	66	65	65	63	63	57	70
	9000	68	67	68	69	69	68	68	60	74
700x400	1200	61	60	56	56	56	57	57	54	64
	4800	64	63	61	60	59	61	61	58	68
	8400	64	66	67	66	66	64	64	58	71
	12000	70	69	70	71	71	70	70	62	76
700x500	1500	64	63	59	59	59	60	60	57	67
	6000	67	66	64	63	62	64	64	61	71
	10500	67	69	70	69	69	67	67	61	74
	15000	73	72	73	74	74	73	73	65	79
800x200	700	59	58	54	54	54	55	55	52	62
	2800	62	61	58	58	58	59	59	56	66
	4900	62	64	61	61	61	62	62	56	69
	7000	66	65	64	64	64	65	65	58	72
800x300	1050	61	60	56	56	56	57	57	54	64
	4200	63	62	60	59	58	60	60	57	67
	7350	63	65	66	65	65	63	63	57	70
	10500	68	67	68	69	69	68	68	60	74

SERIE

RPMC-V

DATOS TÉCNICOS



Nivel de potencia sonora en el interior de la tubería con una diferencia de presión de 250 Pa

		$\Delta P_{st} = 250 \text{ Pa}$								
Dimensión [mm]	V [m³/h]	L_w [dB/Okt]								L_{wA} [dB(A)]
		f_m [Hz]								
		63	125	250	500	1000	2000	4000	8000	
800x400	1400	61	60	56	56	56	57	57	54	64
	5600	64	63	61	60	59	61	61	58	68
	9800	67	69	70	69	69	67	67	61	74
	14000	70	69	70	71	71	70	70	62	76
800x500	1750	65	64	60	60	60	61	61	58	68
	7000	68	67	65	64	63	65	65	62	72
	12250	68	70	71	70	70	68	68	62	75
	17500	73	72	73	74	74	73	73	65	79
800x600	2100	66	65	61	61	61	62	62	59	69
	8400	69	68	66	65	64	66	66	63	73
	14700	68	70	71	70	70	68	68	62	75
	21000	74	73	74	75	75	74	74	66	80
800x800	2800	65	64	60	60	60	61	61	58	68
	11200	69	68	66	65	64	66	66	63	73
	19600	70	72	73	72	72	70	70	64	77
	28000	76	75	76	77	77	76	76	68	82
900x300	1200	63	62	58	58	58	59	59	56	66
	4800	66	65	63	62	61	63	63	60	70
	8400	66	68	69	68	68	66	66	60	73
	12000	70	69	70	71	71	70	70	62	76
900x400	1600	64	63	59	59	59	60	60	57	67
	6400	67	66	64	63	62	64	64	61	71
	11200	67	69	70	69	69	67	67	61	74
	16000	72	71	72	73	73	72	72	64	78
900x500	2000	65	64	60	60	60	61	61	58	68
	8000	68	67	65	64	63	65	65	62	72
	14000	68	70	71	70	70	68	68	62	75
	20000	74	73	74	75	75	74	74	66	80
1000x300	1300	64	63	59	59	59	60	60	57	67
	5200	67	66	64	63	62	64	64	61	71
	9100	67	69	70	69	69	67	67	61	74
	13000	72	71	72	73	73	72	72	64	78
1000x400	1750	64	63	59	59	59	60	60	57	67
	7000	67	66	64	63	62	64	64	61	71
	12250	68	70	71	70	70	68	68	62	75
	17500	73	72	73	74	74	73	73	65	79
1000x500	2200	60	59	55	55	55	56	56	53	63
	8800	68	67	65	64	63	65	65	62	72
	15400	69	71	72	71	71	69	69	63	76
	22000	74	73	74	75	75	74	74	66	80
1000x600	2600	65	64	60	60	60	61	61	58	68
	10400	69	68	66	65	64	66	66	63	73
	18200	69	71	72	71	71	69	69	63	76
	26000	75	74	75	76	76	75	75	67	81
1000x800	3500	66	65	61	61	61	62	62	59	69
	14000	70	69	67	66	65	67	67	64	74
	24500	71	73	74	73	73	71	71	65	78
	35000	77	76	77	78	78	77	77	69	83
1000x1000	4300	67	66	62	62	62	63	63	60	70
	17200	71	70	68	67	66	68	68	65	75
	30100	71	73	74	73	73	71	71	65	78
	43000	77	76	77	78	78	77	77	69	83

SERIE RPMC-V

DATOS TÉCNICOS



Nivel de potencia sonora en el interior de la tubería con una diferencia de presión de 500 Pa

		$\Delta P_{st} = 500 \text{ Pa}$								
Dimensión [mm]	V [m³/h]	L_w [dB/Okt]								L_{WA} [dB(A)]
		f_m [Hz]								
		63	125	250	500	1000	2000	4000	8000	
200x100	90	61	60	56	56	56	57	60	54	64
	360	65	64	62	61	60	62	64	59	69
	630	64	66	67	66	66	64	66	58	71
	900	72	71	72	73	73	72	71	64	78
200x200	180	61	60	56	56	56	57	57	54	64
	720	66	65	63	62	61	63	63	60	70
	1260	66	68	69	68	68	66	66	60	73
	1800	70	69	70	71	71	70	70	62	76
300x100	130	61	60	56	56	56	57	57	54	64
	520	65	64	62	61	60	62	62	59	69
	910	65	67	68	67	67	65	65	59	72
	1300	69	68	69	70	70	69	69	61	75
300x200	260	62	61	57	57	57	58	58	55	65
	1040	67	66	64	63	62	64	64	61	71
	1820	67	69	70	69	69	67	67	61	74
	2600	71	70	71	72	72	71	71	63	77
300x300	390	63	62	58	58	58	59	59	56	66
	1560	67	66	64	63	62	64	64	61	71
	2730	68	70	71	70	70	68	68	62	75
	3900	72	71	72	73	73	72	72	64	78
400x100	180	62	61	57	57	57	58	58	55	65
	720	66	65	63	62	61	63	63	60	70
	1260	66	68	69	68	68	66	66	60	73
	1800	70	69	70	71	71	70	70	62	76
400x200	350	63	62	58	58	58	59	59	56	66
	1400	68	67	65	64	63	65	65	62	72
	2450	68	70	71	70	70	68	68	62	75
	3500	72	71	72	73	73	72	72	64	78
400x300	520	65	64	60	60	60	61	61	58	68
	2080	69	68	66	65	64	66	66	63	73
	3640	69	71	72	71	71	69	69	63	76
	5200	73	72	73	74	74	73	73	65	79
400x400	700	66	65	61	61	61	62	62	59	69
	2800	70	69	67	66	65	67	67	64	74
	4900	69	71	72	71	71	69	69	63	76
	7000	75	74	75	76	76	75	75	67	81
500x100	220	63	62	58	58	58	59	59	56	66
	880	67	66	64	63	62	64	64	61	71
	1540	67	69	70	69	69	67	67	61	74
	2200	70	69	70	71	71	70	70	62	76
500x200	440	63	62	58	58	58	59	59	56	66
	1760	68	67	65	64	63	65	65	62	72
	3080	69	71	72	71	71	69	69	63	76
	4400	72	71	72	73	73	72	72	64	78
500x300	650	65	64	60	60	60	61	61	58	68
	2600	70	69	67	66	65	67	67	64	74
	4550	69	71	72	71	71	69	69	63	76
	6500	74	73	74	75	75	74	74	66	80
500x400	870	67	66	62	62	62	63	63	60	70
	3480	71	70	68	67	66	68	68	65	75
	6090	70	72	73	72	72	70	70	64	77
	8700	76	75	76	77	77	76	76	68	82

SERIE

RPMC-V

DATOS TÉCNICOS



Nivel de potencia sonora en el interior de la tubería con una diferencia de presión de 500 Pa

		$\Delta P_{st} = 500 \text{ Pa}$								
Dimensión [mm]	V [m³/h]	L_w [dB/Okt]								L_{wA} [dB(A)]
		f_m [Hz]								
		63	125	250	500	1000	2000	4000	8000	
500x500	1100	70	69	65	65	65	66	66	63	73
	4400	73	72	70	69	68	70	70	67	77
	7700	73	75	76	75	75	73	73	67	80
	11000	79	78	79	80	80	79	79	71	85
600x100	260	63	62	58	58	58	59	59	56	66
	1040	67	66	64	63	62	64	64	61	71
	1820	67	69	70	69	69	67	67	61	74
	2600	71	70	71	72	72	71	71	63	77
600x200	520	65	64	60	60	60	61	61	58	68
	2080	69	68	66	65	64	66	66	63	73
	3640	69	71	72	71	71	69	69	63	76
	5200	74	73	74	75	75	74	74	66	80
600x300	780	66	65	61	61	61	62	62	59	69
	3120	70	69	67	66	65	67	67	64	74
	5460	70	72	73	72	72	70	70	64	77
	7800	75	74	75	76	76	75	75	67	81
600x400	1050	68	67	63	63	63	64	64	61	71
	4200	71	70	68	67	66	68	68	65	75
	7350	71	73	74	73	73	71	71	65	78
	10500	77	76	77	78	78	77	77	69	83
600x500	1300	71	70	66	66	66	67	67	64	74
	5200	74	73	71	70	69	71	71	68	78
	9100	74	76	77	76	76	74	74	68	81
	13000	80	79	80	81	81	80	80	72	86
600x600	160	70	69	65	65	65	66	66	63	73
	5440	74	73	71	70	69	71	71	68	78
	10720	74	76	77	76	76	74	74	68	81
	16000	81	80	81	82	82	81	81	73	87
700x200	600	66	65	61	61	61	62	62	59	69
	2400	70	69	67	66	65	67	67	64	74
	4200	69	71	72	71	71	69	69	63	76
	6000	74	73	74	75	75	74	74	66	80
700x300	900	67	66	62	62	62	63	63	60	70
	3600	70	69	66	66	66	67	67	64	74
	6300	70	72	73	72	72	70	70	64	77
	9000	76	75	76	77	77	76	76	68	82
700x400	1200	68	67	63	63	63	64	64	61	71
	4800	72	71	69	68	67	69	69	66	76
	8400	72	74	75	74	74	72	72	66	79
	12000	78	77	78	79	79	78	78	70	84
700x500	1500	71	70	66	66	66	67	67	64	74
	6000	75	74	72	71	70	72	72	69	79
	10500	74	76	77	76	76	74	74	68	81
	15000	81	80	81	82	82	81	81	73	87
800x200	700	67	66	62	62	62	63	63	60	70
	2800	70	69	67	66	65	67	67	64	74
	4900	70	72	73	72	72	70	70	64	77
	7000	75	74	75	76	76	75	75	67	81
800x300	1050	68	67	63	63	63	64	64	61	71
	4200	71	71	67	67	67	68	68	65	75
	7350	71	73	74	73	73	71	71	65	78
	10500	77	76	77	78	78	77	77	69	83

SERIE RPMC-V

DATOS TÉCNICOS



Nivel de potencia sonora en el interior de la tubería con una diferencia de presión de 500 Pa

Dimensión [mm]	V [m³/h]	$\Delta P_{st} = 500 \text{ Pa}$								$L_{WA} \text{ [dB(A)]}$
		$L_w \text{ [dB(Okt)]}$								
		$f_m \text{ [Hz]}$								
		63	125	250	500	1000	2000	4000	8000	
800x400	1400	68	67	63	63	63	64	64	61	71
	5600	72	71	69	68	67	69	69	66	76
	9800	72	74	72	71	70	72	72	69	79
	14000	79	78	79	80	80	79	79	71	85
800x500	1750	72	71	67	67	67	68	68	65	75
	7000	75	74	72	71	70	72	72	69	79
	12250	76	78	79	78	78	76	76	70	83
	17500	83	82	83	84	84	83	83	75	89
800x600	2100	72	71	67	67	67	68	68	65	75
	8400	76	75	73	72	71	73	73	70	80
	14700	77	79	80	79	79	77	77	71	84
	21000	84	83	84	85	85	84	84	76	90
800x800	2800	73	72	68	68	68	69	69	66	76
	11200	77	76	74	73	72	74	74	71	81
	19600	79	81	82	81	81	79	79	73	86
	28000	87	86	87	88	88	87	87	79	93
900x300	1200	70	69	65	65	65	66	66	63	73
	4800	74	73	71	70	69	71	71	68	78
	8400	74	76	77	76	76	74	74	68	81
	12000	80	79	80	81	81	80	80	72	86
900x400	1600	75	74	70	70	70	71	71	68	78
	6400	75	74	72	71	70	72	72	69	79
	11200	75	77	78	77	77	75	75	69	82
	16000	82	81	82	83	83	82	82	74	88
900x500	2000	72	71	67	67	67	68	68	65	75
	8000	76	75	73	72	71	73	73	70	80
	14000	76	78	79	78	78	76	76	70	83
	20000	83	82	83	84	84	83	83	75	89
1000x300	1300	70	69	65	65	65	66	66	63	73
	5200	74	73	71	70	69	71	71	68	78
	9100	73	75	76	75	75	73	73	67	80
	13000	79	78	79	80	80	79	79	71	85
1000x400	1750	71	70	66	66	66	67	67	64	74
	7000	75	74	72	71	70	72	72	69	79
	12250	75	77	78	77	77	75	75	69	82
	17500	82	81	82	83	83	82	82	74	88
1000x500	2200	72	71	67	67	67	68	68	65	75
	8800	76	75	73	72	71	73	73	70	80
	15400	77	79	80	79	79	77	77	71	84
	22000	84	83	84	85	85	84	84	76	90
1000x600	2600	73	72	68	68	68	69	69	66	76
	10400	77	76	74	73	72	74	74	71	81
	18200	77	79	80	79	79	77	77	71	84
	26000	85	84	85	86	86	85	85	77	91
1000x800	3500	74	73	69	69	69	70	70	67	77
	14000	78	77	75	74	73	75	75	72	82
	24500	80	82	83	82	82	80	80	74	87
	35000	88	87	88	89	89	88	88	80	94
1000x1000	4300	75	74	70	70	70	71	71	68	78
	17200	79	78	76	75	74	76	76	73	83
	30100	80	82	83	82	82	80	80	74	87
	43000	89	88	89	90	90	89	89	81	95

SERIE RPMC-V

DATOS TÉCNICOS



Ruido radiado

El ruido radiado del controlador de volumen de aire se indica a continuación

V [m^3h^{-1}] - volumen de flujo de aire
 ΔP_{st} [Pa] - presión diferencial

L_{WA} [dB(A)] - nivel total de potencia acústica
 corregido por el filtro A

Dimensión [mm]	V [m^3/h]	L_{WA} [dB(A)]	L_{WA} [dB(A)]	L_{WA} [dB(A)]	L_{WA} [dB(A)]
		$\Delta P_{st}= 50$ Pa	$\Delta P_{st}= 100$ Pa	$\Delta P_{st}= 250$ Pa	$\Delta P_{st}= 500$ Pa
200x100	90	35	39	43	48
	360	37	42	47	53
	630	42	47	52	58
	900	45	49	55	62
200x200	180	40	42	47	49
	720	40	44	49	54
	1260	44	48	52	57
	1800	48	52	55	61
300x100	130	37	40	46	50
	520	38	42	49	55
	910	43	47	54	59
	1300	48	52	58	63
300x200	260	38	41	47	52
	1040	39	44	51	57
	1820	44	49	56	61
	2600	49	53	60	64
300x300	390	39	42	49	54
	1560	40	45	52	58
	2730	45	50	57	63
	3900	52	56	63	68
400x100	180	39	42	47	50
	720	40	44	50	54
	1260	44	48	52	57
	1800	49	52	58	61
400x200	350	39	43	50	55
	1400	41	46	53	60
	2450	45	50	57	63
	3500	49	54	60	66
400x300	520	38	42	50	55
	2080	40	45	53	59
	3640	46	51	58	64
	5200	52	56	63	68
400x400	700	39	43	51	56
	2800	42	47	54	61
	4900	47	52	59	65
	7000	53	57	63	69
500x100	220	39	42	48	52
	880	39	44	51	57
	1540	44	49	55	61
	2200	48	52	58	63
500x200	440	40	43	50	55
	1760	41	46	53	59
	3080	46	51	57	64
	4400	50	55	60	66
500x300	650	41	44	52	57
	2600	43	47	55	61
	4550	47	52	59	65
	6500	52	56	62	69

SERIE RPMC-V

DATOS TÉCNICOS



Dimensión [mm]	V [m³/h]	L _{WA} [dB(A)]	L _{WA} [dB(A)]	L _{WA} [dB(A)]	L _{WA} [dB(A)]
		ΔP _{st} = 50 Pa	ΔP _{st} = 100 Pa	ΔP _{st} = 250 Pa	ΔP _{st} = 500 Pa
500x400	870	40	44	52	57
	3480	43	48	55	61
	6090	47	52	60	66
	8700	53	58	63	70
500x500	1100	42	46	54	58
	4400	46	51	57	64
	7700	51	56	62	70
	11000	57	62	67	76
600x100	260	38	41	47	51
	1040	39	44	51	55
	1820	44	49	56	58
	2600	48	53	59	61
600x200	520	39	42	50	55
	2080	40	45	53	60
	3640	46	51	58	64
	5200	52	56	62	69
600x300	780	39	43	51	57
	3120	41	46	54	60
	5460	46	51	59	65
	7800	52	57	63	70
600x400	1050	40	44	52	59
	4200	44	48	56	63
	7350	49	54	61	68
	10500	54	59	64	72
600x500	1300	41	45	53	59
	5200	45	50	58	65
	9100	53	58	63	71
	13000	62	67	68	78
600x600	160	42	46	53	59
	5440	47	52	58	65
	10720	53	58	64	72
	16000	62	68	68	79
700x200	600	37	42	47	56
	2400	41	46	53	60
	4200	46	51	58	65
	6000	52	56	62	68
700x300	900	40	44	51	57
	3600	42	47	55	61
	6300	47	52	60	66
	9000	52	57	63	70
700x400	1200	41	45	53	59
	4800	44	49	56	64
	8400	49	54	61	68
	12000	54	59	65	73
700x500	1500	42	46	53	60
	6000	47	52	59	66
	10500	53	58	64	72
	15000	63	68	71	79
800x200	700	39	43	51	57
	2800	42	47	54	61
	4900	47	52	59	66
	7000	52	57	62	70

SERIE

RPMC-V

DATOS TÉCNICOS



Dimensión [mm]	V [m³/h]	L _{WA} [dB(A)]	L _{WA} [dB(A)]	L _{WA} [dB(A)]	L _{WA} [dB(A)]
		ΔP _{st} = 50 Pa	ΔP _{st} = 100 Pa	ΔP _{st} = 250 Pa	ΔP _{st} = 500 Pa
800x300	1050	40	44	52	59
	4200	44	48	56	63
	7350	49	54	61	68
	10500	54	59	64	73
800x400	1400	39	44	53	60
	5600	44	49	57	64
	9800	49	54	62	69
	14000	53	60	63	74
800x500	1750	42	46	55	61
	7000	48	53	59	67
	12250	53	59	64	73
	17500	62	69	70	82
800x600	2100	43	47	56	62
	8400	49	54	60	68
	14700	54	60	65	75
	21000	64	70	72	84
800x800	2800	43	48	55	62
	11200	50	55	62	71
	19600	56	62	67	77
	28000	68	74	75	88
900x300	1200	43	47	53	59
	4800	47	52	58	65
	8400	53	58	63	71
	12000	62	66	71	78
900x400	1600	49	47	53	60
	6400	48	53	59	67
	11200	54	59	64	73
	16000	63	68	72	81
900x500	2000	43	48	54	62
	8000	49	54	60	69
	14000	54	60	65	74
	20000	65	70	74	83
1000x300	1300	43	47	53	59
	5200	47	52	58	65
	9100	52	57	63	70
	13000	63	67	70	77
1000x400	1750	42	47	53	60
	7000	48	53	59	67
	12250	55	60	65	73
	17500	65	70	73	80
1000x500	2200	42	47	54	61
	8800	49	54	61	68
	15400	55	60	66	74
	22000	66	71	76	84
1000x600	2600	43	48	54	62
	10400	50	55	61	69
	18200	55	61	66	75
	26000	67	72	76	86
1000x800	3500	44	49	56	63
	14000	51	56	63	72
	24500	57	63	68	78
	35000	69	75	78	89
1000x1000	4300	44	49	57	65
	17200	52	57	64	73
	30100	57	63	69	79
	43000	68	74	78	91