

SERIE

RPM-K



COMPUERTA CAUDAL CONSTANTE

Modelo **RPM-K**. Los reguladores de caudal de aire con flujo constante (CAV) están diseñados para regular el suministro o la salida de aire en los sistemas de ventilación. Pueden instalarse en posición horizontal, vertical o inclinada. Para garantizar un buen funcionamiento, el regulador (CAV) debe instalarse con la posición horizontal de su eje de las aspas. Las fuerzas aerodinámicas que actúan sobre la pala del regulador debido al flujo se equilibran por el dispositivo de control, que se ajusta en función del caudal requerido.

El ajuste del caudal requerido se realiza simplemente mediante una palanca con puntero y escala. Los reguladores mecánicos no necesitan estar conectados a ninguna fuente de energía externa.

El regulador se compone de la caja del regulador con una pala de control y el dispositivo de control.

El dispositivo de control se coloca dentro de la caja con la escala para el ajuste del flujo requerido. La precisión de la escala es de $\pm 5\%$.

Características:

- Tamaño nominal DN 80 a DN 400
- Longitud L = 450
- Espesor según EN 1751 Clase de estanqueidad externa de la carcasa C
- Volumen de flujo de aire 50 a 4 500 m³/h
- Precisión $\pm 15\text{-}20\%$ para velocidades de aire inferiores a 4m/s
- $\pm 10\%$ para velocidades de aire superiores a 4m/s
- Contaminación, deformación del cuerpo de la compuerta o circulación de aire no constante en toda la sección transversal de la compuerta puede traer mayor inexactitud.

Condiciones de trabajo:

- El funcionamiento impecable de los reguladores está garantizado en las siguientes condiciones:
 - a) velocidad máxima del flujo de aire 10 m/s b) presión máxima en el conducto 1000 Pa
 - c) la circulación de aire en toda la sección del controlador debe estar asegurada como constante en toda la superficie
- Los reguladores están diseñados para zonas macroclimáticas con clima suave según la norma EN 60 721-3-3.
- Los reguladores son adecuados para sistemas sin partículas abrasivas, químicas y adhesivas. La temperatura en el lugar de instalación puede oscilar entre 0°C y + 50°C.

Dimensiones:

ø80 a ø400

Modelos:

RPM-K.01
RPM-K.45
RPM-K.46
RPM-K.55
RPM-K.56
RPM-K.57

* ver descripción de modelos en tabla

*

Modelos:

- RPM-K.01** Accionamiento manual
- RPM-K.45** Mecanismo de accionamiento 230V, control de apertura y cierre
- RPM-K.46** Mecanismo de accionamiento 230V, control de apertura y cierre, con contacto final de carrera
- RPM-K.55** Mecanismo de accionamiento 24V, control de apertura y cierre
- RPM-K.56** Mecanismo de accionamiento 24V, control de apertura y cierre, con contacto final de carrera
- RPM-K.57** Mecanismo de accionamiento 24V SR, control proporcional

SERIE RPM-K



RPM-K.01

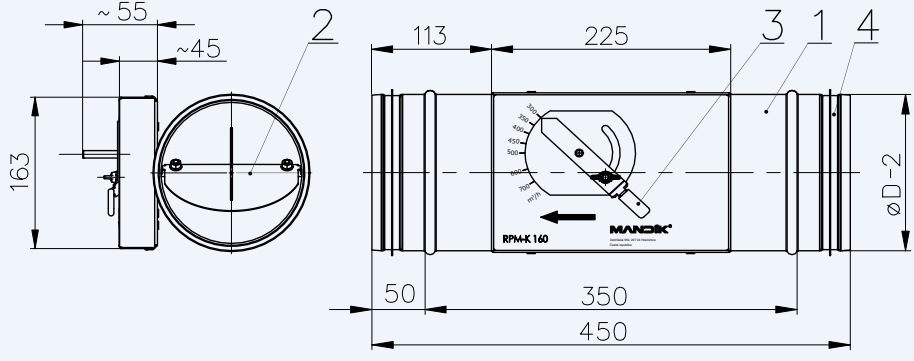

- 1. Tapa del regulador
- 2. Hoja del regulador
- 3. Palanca
- 4. Junta de goma
- 5. Mecanismo de accionamiento

RPM-K.45 / .55

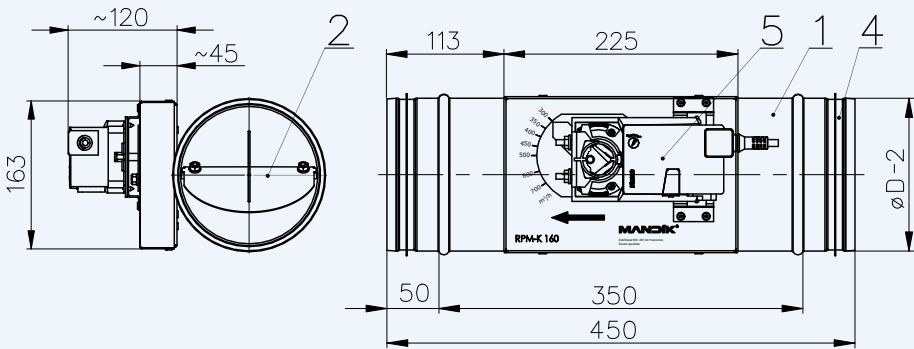

- 1. Tapa del regulador
- 2. Hoja del regulador
- 3. Palanca
- 4. Junta de goma
- 5. Mecanismo de accionamiento

RPM-K Distancia recomendada con respecto a la unión de la rama doble

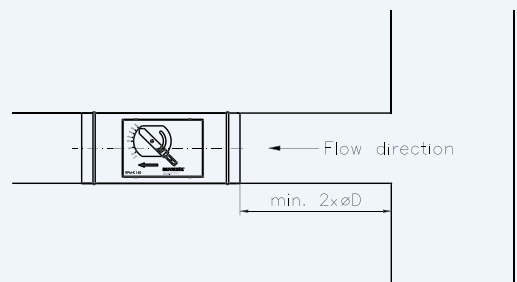

RPM-K Distancia recomendada de la curva

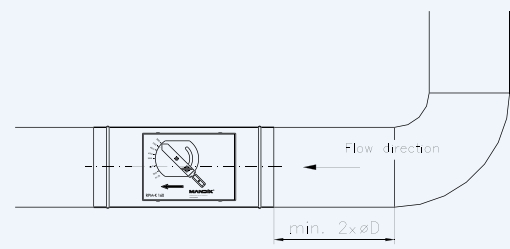

SERIE

RPM-K

DATOS TÉCNICOS



Pérdida de presión

Pérdidas de presión (los valores son válidos cuando la compuerta del regulador está completamente abierta).

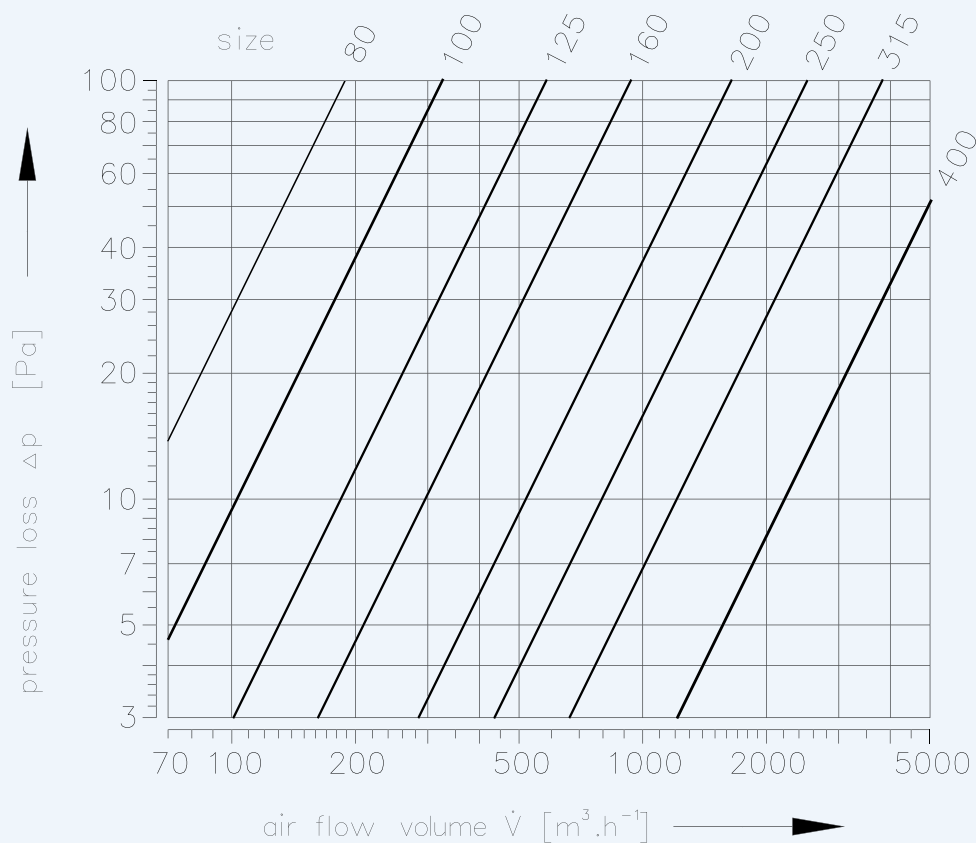

Información de ruido

Ruido regenerado por el aire

El ruido producido por el flujo del regulador de volumen de aire se indica en las siguientes tablas.

\dot{V} [$\text{m}^3 \cdot \text{h}^{-1}$] - volumen de flujo de aire

Δp [Pa] - presión diferencial

L_w [dB/Okt.] - nivel de potencia acústica en la banda de octava

L_{WA} [dB(A)] - nivel total de potencia acústica

corregido por el filtro A

f_m [Hz] - frecuencias medias en las bandas de octava

SERIE

RPM-K

DATOS TÉCNICOS



Nivel de potencia sonora en el interior de la tubería con una diferencia de presión de 50 Pa

$\Delta P_{st} = 50 \text{ Pa}$										
Dimensión [mm]	V [m³/h]	L_w [dB/Okt]								L_{WA} [dB(A)]
		f_m [Hz]								
		63	125	250	500	1000	2000	4000	8000	
80	50	48	38	32	32	35	31	23	<15	38
	100	54	45	41	38	39	34	28	18	43
	150	60	52	48	44	43	39	35	23	48
	200	66	58	54	49	46	42	39	28	52
100	80	49	39	33	33	36	32	24	<15	39
	155	56	47	43	40	41	37	30	20	45
	225	62	54	50	46	45	41	37	26	50
	300	67	59	56	51	48	44	41	30	54
125	125	50	40	34	34	37	33	26	<15	40
	250	58	49	46	43	44	40	33	22	47
	380	64	56	52	48	47	44	40	28	52
	500	70	62	58	53	50	46	43	32	56
160	200	54	44	38	38	41	37	29	18	44
	430	59	50	46	45	44	40	34	23	48
	650	65	57	53	49	48	44	40	28	53
	900	68	61	57	52	49	45	42	31	55
200	300	53	43	37	37	40	36	29	17	43
	630	60	51	47	44	45	41	35	24	49
	960	66	58	54	50	49	45	41	29	54
	1300	72	64	60	55	52	48	45	34	58
250	500	54	44	38	38	41	37	29	18	44
	1000	60	51	47	44	45	41	34	24	49
	1500	66	58	54	50	49	46	42	30	54
	2000	72	64	60	55	52	48	45	34	58
315	800	55	45	39	39	42	38	30	19	45
	1500	62	53	49	46	47	43	36	25	51
	2150	66	58	54	50	49	45	41	30	54
	2800	74	66	62	57	54	50	47	36	60
400	1200	38	28	22	22	25	21	<15	<15	28
	2300	41	32	28	25	26	22	15	<15	30
	3400	44	36	32	28	27	23	19	<15	32
	4500	47	39	35	30	27	23	20	<15	33

SERIE

RPM-K

DATOS TÉCNICOS



Nivel de potencia sonora en el interior de la tubería con una diferencia de presión de 100 Pa

$\Delta P_{st} = 100 \text{ Pa}$

Dimensión [mm]	V [m³/h]	L_w [dB/Okt]								L_{WA} [dB(A)]
		f_m [Hz]								
		63	125	250	500	1000	2000	4000	8000	
80	50	52	42	36	36	39	35	27	15	42
	100	58	49	45	42	43	39	32	21	47
	150	64	56	52	48	47	43	39	27	52
	200	70	62	58	53	50	46	43	32	56
100	80	53	43	37	37	40	36	28	16	43
	155	60	51	47	44	45	41	34	23	49
	225	66	58	54	50	49	45	41	29	54
	300	72	64	60	55	52	48	45	34	58
125	125	55	45	39	39	42	38	30	18	45
	250	63	54	50	47	48	44	37	26	52
	380	69	61	57	53	52	48	44	32	57
	500	74	66	62	57	55	50	47	36	61
160	200	58	48	42	42	45	41	33	21	48
	430	64	55	51	48	49	45	38	27	53
	650	69	61	57	53	52	48	44	32	57
	900	74	66	62	57	54	50	47	36	60
200	300	58	48	42	42	45	41	33	21	48
	630	65	56	52	49	50	46	39	28	54
	960	70	62	58	54	53	49	45	33	58
	1300	76	68	64	59	56	52	49	38	62
250	500	59	49	43	43	46	42	34	22	49
	1000	65	56	52	49	50	46	39	28	54
	1500	71	63	59	55	54	50	46	34	59
	2000	76	68	64	59	56	52	49	38	62
315	800	60	50	44	44	47	43	35	23	50
	1500	66	57	53	50	51	47	40	29	55
	2150	71	63	59	55	54	50	46	34	59
	2800	78	70	65	59	57	53	51	40	63
400	1200	67	58	54	51	52	48	41	30	56
	2300	70	62	58	54	55	51	45	33	59
	3400	73	65	60	57	58	53	49	36	62
	4500	76	68	64	60	59	55	51	39	64

SERIE

RPM-K

DATOS TÉCNICOS



Nivel de potencia sonora en el interior de la tubería con una diferencia de presión de 250 Pa

$\Delta P_{st} = 250 \text{ Pa}$										
Dimensión [mm]	V [m³/h]	L_w [dB/Okt]								L_{WA} [dB(A)]
		f_m [Hz]								
		63	125	250	500	1000	2000	4000	8000	
80	50	58	48	42	42	45	41	33	21	48
	100	64	55	51	48	49	45	38	27	53
	150	70	62	58	54	53	49	45	33	58
	200	76	68	64	59	56	52	49	38	62
100	80	59	49	43	43	46	42	34	22	49
	155	65	56	52	49	50	46	39	28	54
	225	73	65	61	56	55	52	48	36	60
	300	77	69	65	60	57	53	50	39	63
125	125	64	54	48	47	50	47	39	27	53
	250	69	60	56	53	54	50	43	32	58
	380	75	67	63	59	58	54	50	38	63
	500	81	73	69	64	61	58	55	44	67
160	200	66	56	50	50	53	49	41	29	56
	430	72	63	59	56	57	53	46	35	61
	650	77	69	65	61	60	56	52	40	65
	900	79	73	69	64	63	55	53	42	68
200	300	67	57	51	51	54	50	42	30	57
	630	72	63	59	56	57	53	46	35	61
	960	77	69	65	61	60	56	52	40	65
	1300	81	73	69	64	61	57	54	43	67
250	500	68	58	52	52	55	51	43	31	58
	1000	72	63	59	58	58	53	46	35	62
	1500	77	69	65	62	61	57	52	40	66
	2000	82	74	70	65	63	58	55	44	69
315	800	68	58	52	52	55	51	43	31	58
	1500	74	65	61	58	59	55	48	37	63
	2150	78	70	66	62	61	57	53	41	66
	2800	82	74	70	65	63	58	55	44	69
400	1200	73	64	58	58	60	57	50	37	64
	2300	75	67	63	61	62	58	50	38	66
	3400	77	69	66	63	65	59	51	41	68
	4500	81	74	70	66	65	61	56	44	70

SERIE RPM-K

DATOS TÉCNICOS



Nivel de potencia sonora en el interior de la tubería con una diferencia de presión de 500 Pa

$\Delta P_{st} = 500 \text{ Pa}$

Dimensión [mm]	V [m³/h]	L_w [dB/Okt]								L_{WA} [dB(A)]
		f_m [Hz]								
		63	125	250	500	1000	2000	4000	8000	
80	50	64	54	48	48	51	47	39	27	54
	100	70	61	57	54	55	51	44	33	59
	150	76	68	64	60	59	55	51	39	64
	200	82	74	70	65	62	58	55	44	68
100	80	65	55	49	49	52	48	40	28	55
	155	71	62	58	55	56	52	45	34	60
	225	78	70	66	62	61	57	53	41	66
	300	83	75	71	66	63	60	57	46	69
125	125	71	61	55	54	57	54	46	34	60
	250	76	67	63	60	61	57	50	39	65
	380	82	74	70	66	65	61	57	45	70
	500	87	79	75	70	67	63	60	49	73
160	200	72	62	56	56	59	55	47	35	62
	430	79	70	66	63	63	60	53	42	67
	650	83	75	71	67	66	62	58	46	71
	900	88	80	76	71	68	64	61	50	74
200	300	74	64	58	58	61	57	49	37	64
	630	79	70	66	63	64	60	53	42	68
	960	83	75	71	67	66	62	58	46	71
	1300	87	79	75	70	67	63	60	49	73
250	500	76	66	60	60	63	59	51	39	66
	1000	80	71	67	64	65	61	54	43	69
	1500	84	76	72	68	67	63	59	47	72
	2000	88	80	76	71	68	64	61	50	74
315	800	76	66	60	60	63	59	51	39	66
	1500	80	71	67	66	66	61	54	43	70
	2150	85	77	73	68	67	64	60	48	72
	2800	88	80	76	71	68	64	61	50	74
400	1200	79	70	65	66	68	62	53	42	71
	2300	83	74	70	68	69	65	58	47	73
	3400	86	76	73	70	71	66	59	48	75
	4500	88	81	77	73	72	68	64	51	77

SERIE RPM-K

DATOS TÉCNICOS



Nivel de potencia sonora L_{wa} (dB (A)) en el interior de la conducción

∅ 80

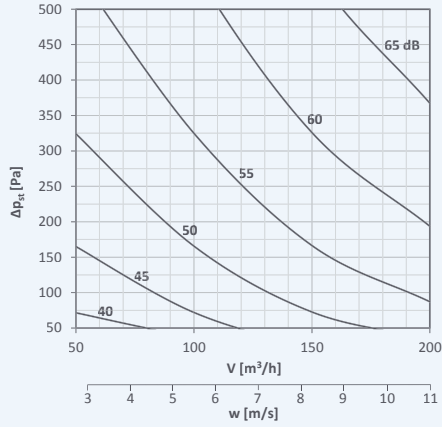

∅ 100

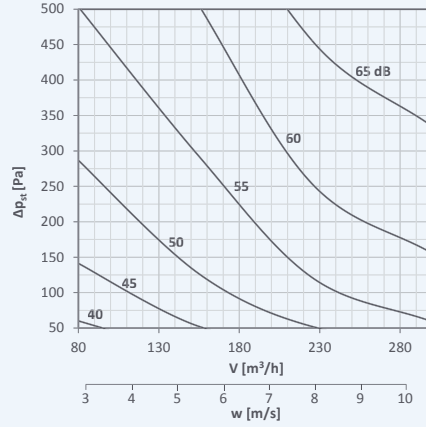

∅ 125

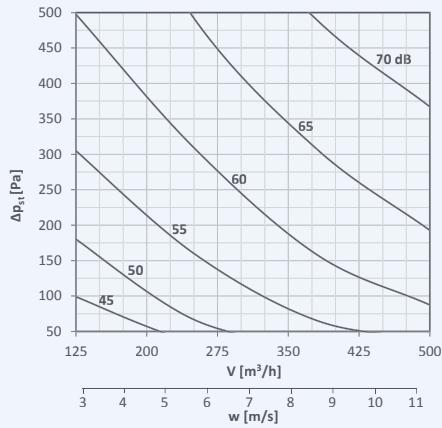

∅ 160

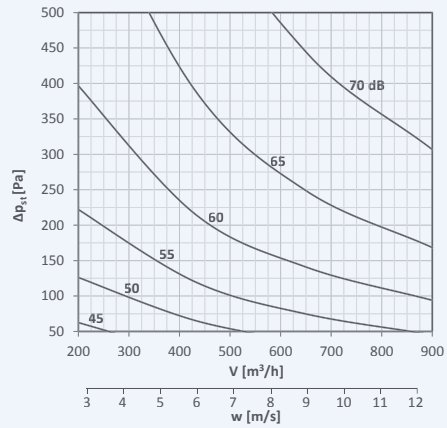

∅ 200

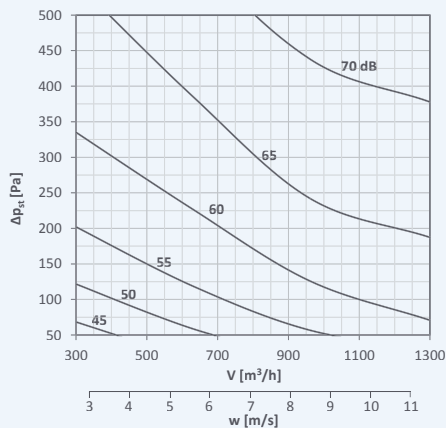

∅ 250

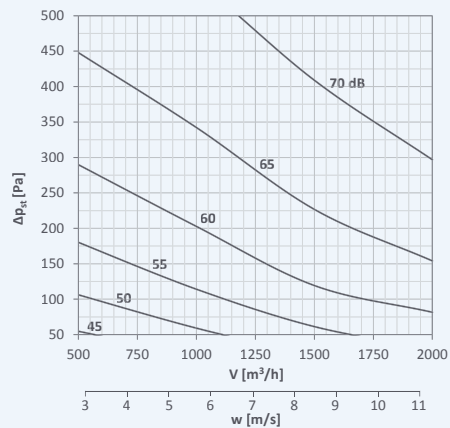

SERIE RPM-K

DATOS TÉCNICOS



REGULACIÓN

Nivel de potencia sonora L_{wa} (dB (A)) en el interior de la conducción

Ø 315

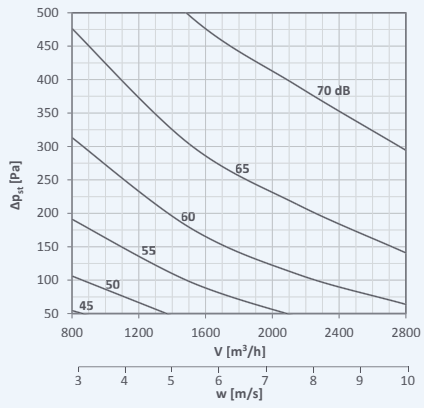

Ø 400

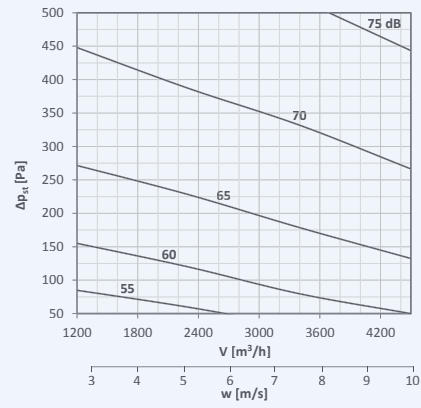

SERIE RPM-K

DATOS TÉCNICOS



Nivel de potencia acústica radiada en el exterior de la tubería - sin aislamiento

El ruido radiado del controlador de volumen de aire se indica a continuación

Ruido radiado

V [m³h⁻¹] - volumen de flujo de aire
 ΔP_{st} [Pa] - presión diferencial

L_{WA} [dB(A)] - nivel total de potencia acústica
 corregido por el filtro A

Dimensión [mm]	V [m ³ /h]	L _{WA} [dB(A)]	L _{WA} [dB(A)]	L _{WA} [dB(A)]	L _{WA} [dB(A)]
		$\Delta P_{st}= 50$ Pa	$\Delta P_{st}= 100$ Pa	$\Delta P_{st}= 250$ Pa	$\Delta P_{st}= 500$ Pa
80	100	<15	<15	<15	<15
	150	<15	<15	15	20
	200	<15	<15	17	22
100	80	<15	<15	<15	<15
	155	<15	<15	<15	15
	225	<15	<15	19	22
	300	<15	<15	20	25
125	125	<15	<15	<15	15
	250	<15	<15	15	20
	380	<15	17	24	28
	500	18	21	28	30
160	200	<15	<15	19	22
	430	<15	18	26	30
	650	20	23	32	35
	900	21	25	31	37
200	300	<15	15	20	22
	630	16	19	25	30
	960	22	26	34	38
	1300	25	29	36	40
250	500	<15	15	23	27
	1000	16	20	28	33
	1500	24	28	36	42
	2000	27	31	39	44
315	800	<15	16	22	27
	1500	18	22	28	34
	2150	25	29	35	41
	2800	29	33	38	45
400	1200	19	22	28	32
	2300	24	27	33	37
	3400	30	33	39	43
	4500	33	36	42	46

SERIE

RPM-K

DATOS TÉCNICOS



Nivel de potencia sonora L_{wa} (dB (A)) en el interior de la conducción - sin aislamiento

Ø 80

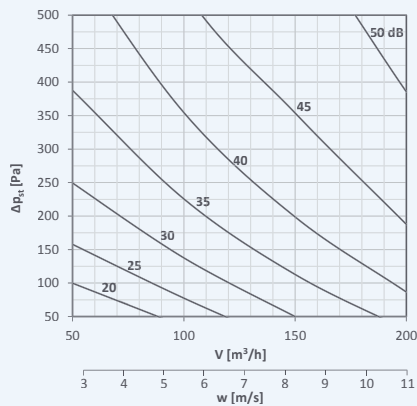

Ø 100

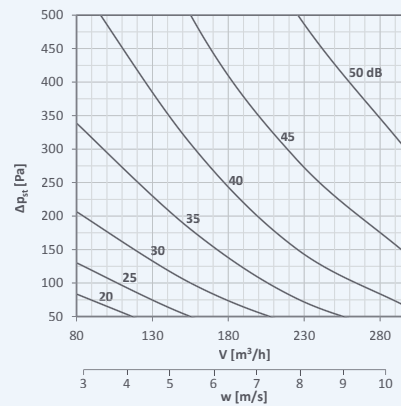

Ø 125

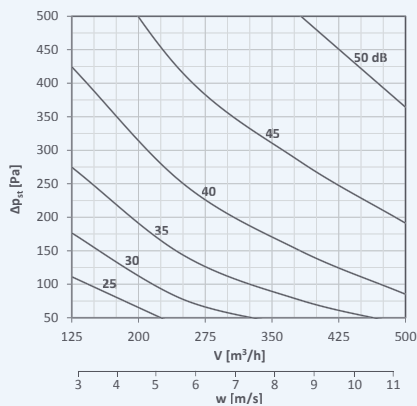

Ø 160

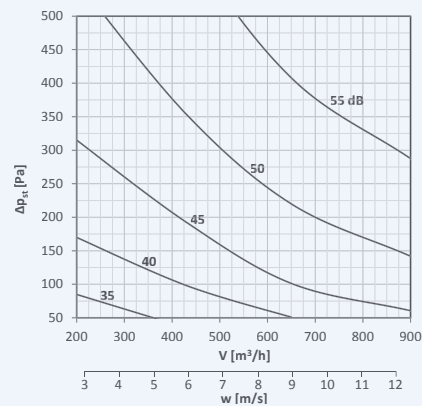

Ø 200

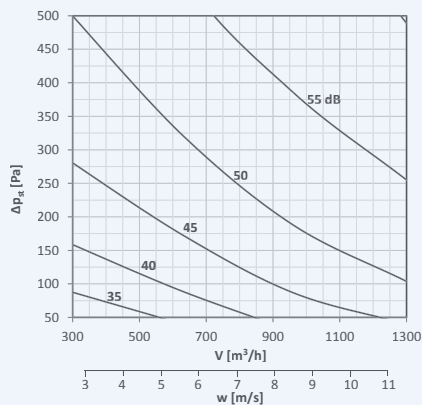

Ø 250

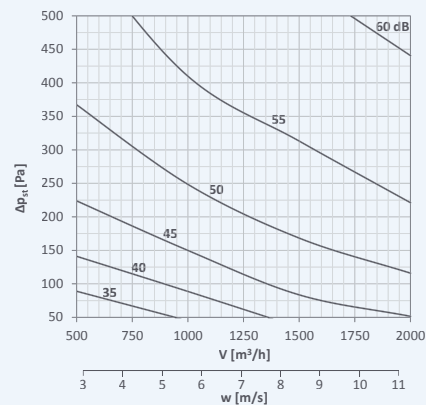

SERIE RPM-K

DATOS TÉCNICOS



Nivel de potencia sonora L_{wa} (dB (A)) en el interior de la conducción - sin aislamiento

Ø 315

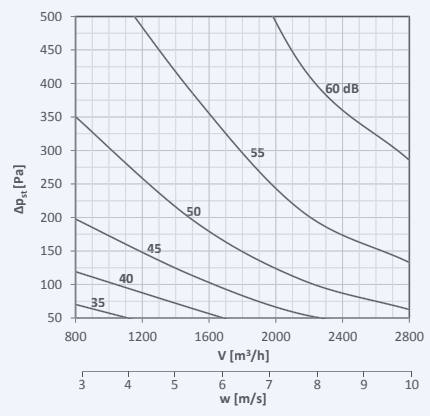

Ø 400

