

SERIE RPM-V



COMPUERTA CAUDAL VARIABLE

Modelo **RPM-V**. Los reguladores de volumen de aire están pensados para sistemas con un volumen de aire variable que se utiliza para la entrada o salida de aire. La cantidad de aire necesaria que se introduce en las distintas salas o zonas de trabajo es variable con respecto al tiempo y puede cambiarse según la necesidad momentánea cuando los controladores están instalados. La potencia total del sistema de aire acondicionado puede ser menor. Esta variable permiten un funcionamiento más económico de los sistemas de aire acondicionado y al mismo tiempo garantizan el bienestar individual en la configuración de los locales.

El controlador consiste en el cuerpo del controlador con una hoja de control y sondas de presión para determinar el flujo de aire. En el cuerpo del regulador se encuentra un regulador compacto para controlar la la hoja de control.

Características:

- Tipo de regulación:
control del caudal de aire
control de la presión en el conducto
control de la presión en el local
- Tamaño nominal: DIM 80 a DIM 630
- Longitud L = 450 / 600 mm según el tamaño nominal
- Estanqueidad según la norma EN 1751 Estanqueidad exterior de la carcasa clase C Estanqueidad a través de la hoja de la compuerta: clase 4
- Volumen de flujo de aire 18 ÷ 7 900 m³/h (para 12m/s es un volumen def lujo de aire máximo de 13 500 m³/h)
- Precisión ± 8 % para velocidad hasta 3 m/s y ± 5 % para velocidad superior.
- Velocidad del aire La configuración estándar está en el rango de min. 1 m/s a 7 m/s por Belimo.

Condiciones de trabajo:

- El funcionamiento correcto de los reguladores está garantizado en las siguientes condiciones a) velocidad máxima del flujo de aire 7 m/s
b) presión máxima en el conducto 1000 Pa
c) la circulación de aire en toda la sección del regulador debe estar asegurada como constante en toda superficie
- Los reguladores están diseñados para zonas macroclimáticas con clima suave según la norma EN 60 721-3-3.
- Los reguladores son adecuados para sistemas sin partículas abrasivas, químicas y adhesivas. La temperatura en el lugar de instalación puede oscilar entre 0°C y +50°C.
- Los reguladores se suministran sin aislamiento o con un diseño aislado. El grosor del aislamiento es de 50 mm.

Modelos:

RPM-V.01 Para control con señal 0(2)...10 V o protocolo MP-BUS.

RPM-V.02 Para control con la señal 0(2)...10 V o utilizando el protocolo Modbus RTU, BACnet o MP-BUS

Opcionales:

RPM-V.75

RPM-V.78

RPM-V.91

RPM-V.92

* ver descripción de modelos en tabla.

* Flujo de aire		solución compacta (sensor, controlador y actuador en una sola caja)		Dinámico	Analog MPBus (5 N.m, NMV-D3-MP 10 N.m, SMV-D3-MP 20 N.m)	LMV-D3-MP	0...500Pa	.01
Presión		sensor, controller and actuador all in separate boxes		Estática	MODBUS BACnet MPBus (5 N.m, NMV-D3-MOD 10 N.m, SMV-D3-MOD 20 N.m)	LMV-D3-MOD	0...500Pa	.02
Presión en la sala		sensor, controller and actuador all in separate boxes		Estática	Analog MP-Bus (5 N.m., NM24A-VST 10 N.m, SM24A-VST 20 N.m)	Controlador VRU-M1-BAC (STP) + LM24A-VST	0...600 Pa	.75
					ModBus (5 N.m., NM24A-VST 10 N.m, SM24A-VST 20 N.m)	Controlador VRU-M1-BAC (STP) + LM24A-VST	0...600 Pa	.78
					BACnet (5 N.m., NM24A-VST 10 N.m, SM24A-VST 20 N.m)	Controlador VRU-M1R-BAC (STP) + LM24A-VST	-75...+75	.91
					ModBus BACnet (5 N.m., NM24A-VST 10 N.m, SM24A-VST 20 N.m)	Controlador VRU-M1R-BAC (STP) + LM24A-VST	-75...+75	.92

SERIE RPM-V



RPM-V

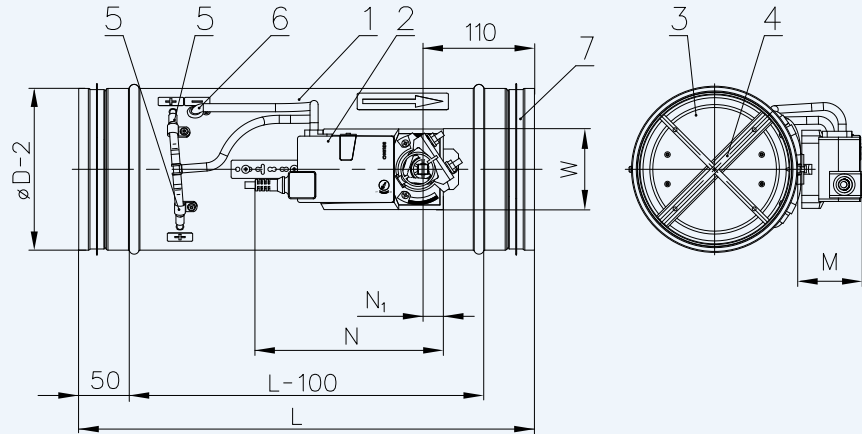

1. Cuerpo del regulador
2. Controlador
3. Hoja del controlador
4. Pestaña
5. Muestreo de presión -p1
6. Muestreo de presión -p2
7. Junta de goma

RPM-V

Control de flujo de aire

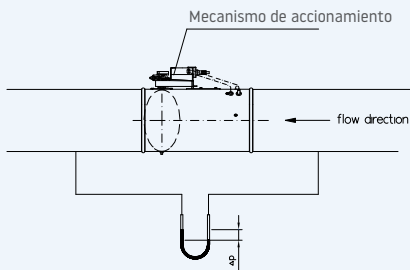

Δp [Pa] pérdida de presión del controlador

RPM-V

Control de la presión del conducto

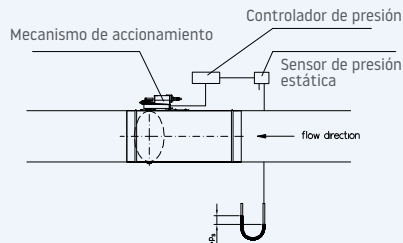

Δp_s [Pa] Diferencia de presión estática entre el conducto y el entorno

RPM-V

Control de la presión de la sala

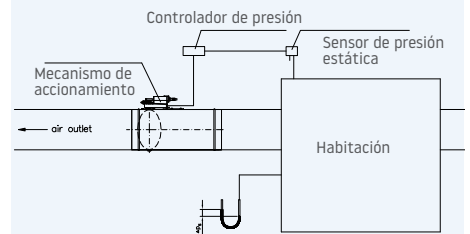

Δp_s [Pa] Diferencia de presión estática entre la sala y el entorno

RPM-V

Distancia recomendada con respecto a la unión de la rama doble

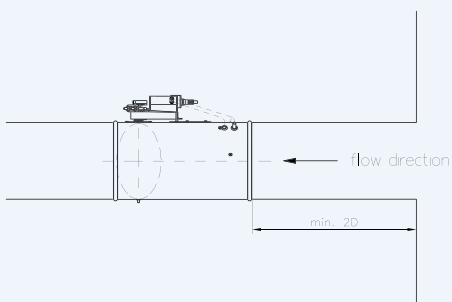

RPM-V

Distancia recomendada de la curva

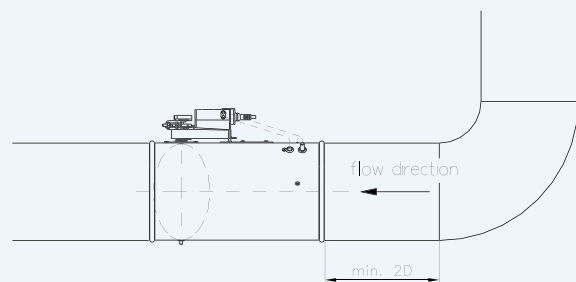

SERIE RPM-V

DATOS TÉCNICOS



Volumen de aire

Dimensiones AxB [mm]	Volumen de aire [m³/h]					
	Valores estándar*			Valores máximos		
	Mínimo (w ≈ 1m/s)	Máximo (w ≈ 7m/s)	V _{nom}	Mínimo (w ≈ 1m/s)	Máximo (w ≈ 12m/s)	V _{nom}
80	18	125	125	18	220	220
100	30	200	200	30	350	350
125	45	310	310	45	550	550
140	55	400	400	55	700	700
160	70	500	500	70	900	900
180	90	650	650	90	1200	1200
200	115	800	800	115	1400	1400
225	145	1000	1000	145	1800	1800
250	180	1250	1250	180	2200	2200
280	220	1550	1550	220	2800	2800
315	280	2000	2000	280	3500	3500
355	355	2500	2500	355	4500	4500
400	455	3200	3200	455	5800	5800
500	710	5000	5000	710	8500	8500
630	1120	7900	7900	1120	13500	13500

*Configuración por defecto del controlador

SERIE

RPM-V

DATOS TÉCNICOS



Determinación del volumen de aire efectivo

El valor del volumen de aire se determina mediante el cálculo a partir del valor medido U_5

Ejemplo: Modo de funcionamiento 2...10V

$$\dot{V} = \frac{U_5 - 2,0}{8} \cdot \dot{V}_{nom}$$

Ejemplo: Modo de funcionamiento 0...10V

$$\dot{V} = \frac{U_5 \cdot \dot{V}_{nom}}{10}$$

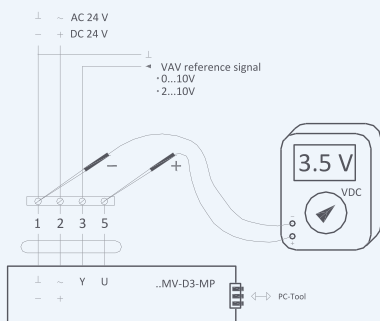

Búsqueda para: volumen de aire efectivo

Tensión medida en U_5 : 3,5 V

$$\dot{V}_{nom} = 2800 \text{ m}^3 \cdot \text{h}^{-1}$$

$$\dot{V} = \frac{3,5 - 2,0}{8} \cdot 2800 = 525$$

El volumen de aire actual es $525 \text{ m}^3 \cdot \text{h}^{-1}$.

Búsqueda para: volumen de aire efectivo

Tensión medida en U_5 : 3,5 V

$$\dot{V}_{nom} = 2200 \text{ m}^3 \cdot \text{h}^{-1}$$

$$\dot{V} = \frac{3,5 \cdot 2200}{10} = 770$$

El volumen de aire actual es $770 \text{ m}^3 \cdot \text{h}^{-1}$.

Pérdida de presión

Pérdidas de presión (los valores son válidos cuando la compuerta del regulador está completamente abierta)

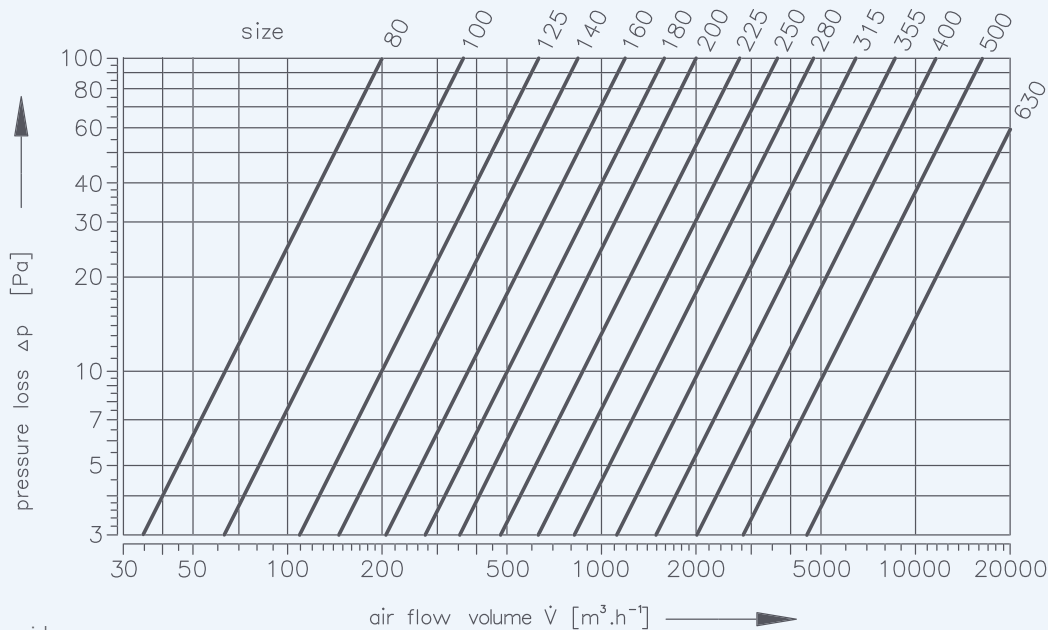

Información de ruido
Ruido regenerado por el aire

El ruido producido por el flujo del regulador de volumen de aire se indica en las siguientes tablas

V [$\text{m}^3 \cdot \text{h}^{-1}$] - volumen de flujo de aire

Δp [Pa] - presión diferencial

L_w [dB/Okt.] - nivel de potencia acústica en la banda de octava

L_{WA} [dB(A)] - nivel total de potencia acústica corregido por el filtro A

f_m [Hz] - frecuencias medias en las bandas de octava

SERIE

RPM-V

DATOS TÉCNICOS



REGULACIÓN

Nivel de potencia sonora en el interior de la tubería con una diferencia de presión de 50 Pa

$\Delta P_{st} = 50 \text{ Pa}$										
Dimensión [mm]	V [m³/h]	L_w [dB/Okt]								L_{WA} [dB(A)]
		f_m [Hz]								
		63	125	250	500	1000	2000	4000	8000	
80	18	40	31	31	25	28	24	18	7	32
	88	54	44	38	38	41	37	29	18	44
	154	59	49	43	43	46	43	35	23	49
	220	63	53	47	47	50	46	38	27	53
100	30	42	33	27	27	31	26	20	9	34
	140	58	49	45	45	43	39	39	22	48
	245	65	58	54	54	49	50	41	29	56
	350	69	63	59	59	51	53	42	31	60
125	45	44	34	28	28	31	28	20	10	34
	220	59	50	46	43	44	41	34	24	48
	385	64	56	52	48	47	43	40	28	52
	550	71	63	59	54	51	43	44	34	57
140	55	45	36	30	30	33	29	21	11	36
	280	61	52	49	45	43	40	36	25	49
	490	64	57	53	49	48	44	40	28	53
	700	72	64	60	55	52	48	45	35	58
160	70	48	39	32	32	36	32	23	14	39
	360	60	51	47	44	46	41	34	24	49
	630	66	58	54	50	49	45	41	30	54
	900	72	65	60	57	54	49	46	35	59
180	90	48	38	33	33	36	32	24	13	39
	480	60	51	47	45	45	42	35	24	49
	840	66	58	55	51	50	46	42	30	55
	1200	74	66	62	57	54	50	47	37	60
200	115	47	36	31	31	35	33	24	13	39
	560	60	51	47	45	46	42	35	24	49
	980	68	60	56	52	51	47	43	31	56
	1400	75	67	63	58	55	51	38	38	61
225	145	49	39	33	33	36	32	25	13	39
	720	60	51	47	45	46	42	35	24	49
	1260	68	60	56	52	51	47	43	32	56
	1800	75	67	63	59	56	52	49	38	61
250	180	48	36	32	32	34	31	23	12	38
	880	61	53	49	46	47	43	36	26	51
	1540	68	61	57	53	52	48	44	32	57
	2200	74	66	63	58	55	51	48	37	61
280	220	50	40	34	34	36	33	27	15	40
	1120	64	56	52	49	50	46	39	28	54
	1960	69	62	58	54	53	49	45	33	58
	2800	77	69	65	60	57	50	50	39	63
315	280	49	55	34	34	37	33	25	15	42
	1400	63	55	51	48	49	45	38	27	53
	2450	70	62	58	54	53	49	45	34	58
	3500	78	70	66	61	58	54	51	40	64
355	355	51	41	36	36	39	37	28	17	43
	1800	63	54	50	47	48	44	38	27	52
	3150	70	62	58	54	53	49	45	34	58
	4500	77	69	65	60	57	53	50	40	63
400	455	53	44	38	38	41	37	29	18	44
	2320	63	54	50	47	48	44	38	27	52
	4060	70	62	58	54	53	49	45	34	58
	5800	76	68	64	59	57	53	50	39	63
500	710	49	40	34	34	37	33	25	15	40
	4200	64	55	51	48	49	45	39	28	53
	6300	71	63	59	55	54	50	46	35	59
	8500	77	69	65	60	58	54	51	40	63
630	1120	52	44	38	38	41	37	30	20	44
	6700	66	57	53	50	51	47	40	30	55
	10000	73	65	61	57	56	52	48	37	61
	13500	78	70	66	62	60	56	53	42	65

SERIE

RPM-V

DATOS TÉCNICOS



Nivel de potencia sonora en el interior de la tubería con una diferencia de presión de 100 Pa

$\Delta P_{st} = 100 \text{ Pa}$

Dimensión [mm]	V [m³/h]	L_w [dB/Okt]								L_{WA} [dB(A)]
		f_m [Hz]								
		63	125	250	500	1000	2000	4000	8000	
80	18	46	36	30	30	34	29	21	9	37
	88	59	49	43	43	46	42	34	22	49
	154	64	54	48	48	51	47	39	27	54
	220	68	58	52	52	55	51	43	31	58
100	30	48	38	32	32	35	31	23	12	38
	140	63	54	50	50	48	44	37	26	52
	245	70	62	59	59	53	49	45	33	60
	350	73	66	64	64	55	51	47	35	64
125	45	49	39	33	33	37	32	24	13	40
	220	65	56	52	50	49	45	39	28	53
	385	69	61	57	53	52	48	44	32	57
	550	76	68	64	59	56	52	49	38	62
140	55	51	41	35	35	38	34	26	14	41
	280	65	56	52	49	50	46	39	28	54
	490	70	62	58	54	53	49	45	33	58
	700	77	69	65	60	57	53	50	39	63
160	70	54	44	38	38	41	37	30	17	44
	360	65	56	52	49	50	46	39	28	54
	630	71	63	59	55	54	50	46	34	59
	900	78	70	66	61	58	54	51	40	64
180	90	54	44	38	38	41	37	29	17	44
	480	66	57	53	50	51	47	40	29	55
	840	72	64	60	56	55	51	47	35	60
	1200	79	71	67	62	59	55	52	41	65
200	115	54	44	38	38	42	37	29	18	45
	560	66	57	53	50	51	47	40	29	55
	980	73	65	61	57	56	52	48	36	61
	1400	80	72	68	63	60	56	53	42	66
225	145	55	45	39	39	43	38	29	18	46
	720	66	57	53	50	51	47	40	29	55
	1260	73	65	61	57	56	52	48	36	61
	1800	80	72	68	63	60	56	53	42	66
250	180	52	43	37	37	41	36	28	16	44
	880	67	58	54	51	52	48	41	30	56
	1540	73	65	61	57	56	52	48	36	61
	2200	79	71	67	62	59	55	52	41	65
280	220	55	45	39	39	43	39	31	19	46
	1120	70	61	57	54	55	51	44	33	59
	1960	74	66	62	58	57	53	49	37	62
	2800	81	73	69	64	61	57	54	43	67
315	280	56	46	41	41	44	41	32	20	47
	1400	69	60	56	53	54	50	43	32	58
	2450	75	67	63	59	58	54	50	38	63
	3500	82	74	70	65	62	58	55	44	68
355	355	58	48	42	42	46	41	33	31	49
	1800	69	60	56	53	54	50	43	32	58
	3150	75	67	63	59	58	55	51	39	63
	4500	82	74	70	65	62	58	55	44	68
400	455	58	49	42	42	46	42	34	22	49
	2320	69	60	56	53	54	50	43	32	58
	4060	76	68	64	60	59	55	51	39	64
	5800	82	74	70	65	62	58	55	44	68
500	710	56	46	40	40	43	39	31	21	46
	4200	69	60	56	53	54	51	44	33	58
	6300	77	69	65	61	60	56	52	40	65
	8500	82	74	70	65	62	59	56	45	68
630	1120	60	49	44	44	45	43	35	23	49
	6700	72	63	59	56	57	53	46	35	61
	10000	79	71	67	63	62	58	54	42	67
	13500	85	77	73	68	65	61	58	47	71

SERIE

RPM-V

DATOS TÉCNICOS



REGULACIÓN

Nivel de potencia sonora en el interior de la tubería con una diferencia de presión de 250 Pa

$\Delta P_{st} = 250 \text{ Pa}$

Dimensión [mm]	V [m³/h]	L_w [dB/Okt]								L_{WA} [dB(A)]
		f_m [Hz]								
		63	125	250	500	1000	2000	4000	8000	
80	18	54	44	38	38	41	37	29	17	44
	88	67	57	51	51	54	50	42	30	57
	154	72	62	56	56	59	55	47	35	62
	220	76	66	60	60	63	59	51	39	66
100	30	56	46	41	41	43	40	32	20	47
	140	70	61	57	57	55	52	44	33	60
	245	77	69	65	66	61	55	52	40	67
	350	83	75	71	72	63	59	56	45	72
125	45	58	48	42	42	45	41	33	21	48
	220	70	61	58	55	56	51	45	34	60
	385	77	69	65	61	60	55	51	39	65
	550	83	75	71	65	62	58	55	44	69
140	55	60	50	44	44	48	44	35	23	51
	280	72	63	59	56	57	53	46	35	61
	490	77	69	65	61	60	56	52	40	65
	700	83	75	71	66	63	59	56	45	69
160	70	61	51	45	45	49	44	36	24	52
	360	73	64	60	57	58	54	47	36	62
	630	78	70	66	62	61	57	53	41	66
	900	84	76	72	67	64	60	57	46	70
180	90	63	53	47	47	50	45	37	25	53
	480	73	65	62	59	58	55	47	36	63
	840	78	71	67	63	62	57	53	41	67
	1200	84	77	74	69	65	61	57	46	72
200	115	63	53	47	47	51	46	38	26	54
	560	74	65	61	58	59	55	48	37	63
	980	79	72	68	64	63	58	54	42	68
	1400	85	77	73	69	65	61	58	47	72
225	145	64	54	48	48	51	49	40	28	55
	720	74	65	61	58	59	55	48	37	63
	1260	80	72	68	64	63	59	55	43	68
	1800	86	78	74	69	66	62	59	48	72
250	180	64	55	48	48	50	47	40	27	54
	880	74	65	61	58	59	55	48	37	63
	1540	80	72	68	64	63	59	55	43	68
	2200	86	78	74	69	66	62	59	48	72
280	220	65	55	49	49	53	48	41	29	56
	1120	76	67	63	60	61	56	49	38	65
	1960	81	73	69	65	64	60	56	44	69
	2800	87	79	75	70	67	63	60	49	73
315	280	66	57	50	50	53	51	43	30	57
	1400	76	67	63	60	61	57	50	39	65
	2450	82	74	70	66	65	61	57	45	70
	3500	88	80	76	71	68	64	61	50	74
355	355	67	57	51	51	54	52	43	31	58
	1800	77	68	64	61	62	58	51	40	66
	3150	82	75	71	67	67	62	57	45	71
	4500	88	80	76	71	68	64	61	50	74
400	455	70	60	54	54	58	53	45	33	61
	2320	77	69	65	62	63	59	51	40	67
	4060	82	75	71	67	66	62	57	45	71
	5800	88	80	76	71	68	64	61	50	74
500	710	66	56	50	50	53	49	42	30	56
	4200	79	70	66	63	64	60	53	42	68
	6300	84	76	73	69	68	63	59	47	73
	8500	90	82	78	73	70	66	63	52	76
630	1120	68	58	50	50	52	50	43	31	56
	6700	81	72	68	65	66	62	55	44	70
	10000	86	79	75	71	70	65	61	49	75
	13500	92	84	80	75	72	68	65	54	78

SERIE

RPM-V

DATOS TÉCNICOS



Nivel de potencia sonora en el interior de la tubería con una diferencia de presión de 500 Pa

$\Delta P_{st} = 500 \text{ Pa}$

Dimensión [mm]	V [m³/h]	L_w [dB/Okt]								L_{WA} [dB(A)]
		f_m [Hz]								
		63	125	250	500	1000	2000	4000	8000	
80	18	61	51	45	45	48	46	37	25	52
	88	74	64	58	58	61	58	50	38	64
	154	79	70	63	63	66	62	54	42	69
	220	83	73	67	68	70	67	59	47	73
100	30	64	54	48	48	51	47	39	27	54
	140	77	68	64	64	62	58	51	40	66
	245	84	76	72	72	67	63	59	47	73
	350	90	82	78	78	70	66	63	52	78
125	45	66	54	50	50	54	50	41	29	57
	220	78	69	65	61	63	58	51	40	66
	385	83	75	71	67	66	63	59	47	71
	550	89	81	77	72	69	66	63	52	75
140	55	67	57	51	51	54	50	42	30	57
	280	79	70	66	63	64	60	53	42	68
	490	81	76	72	68	67	63	59	47	72
	700	89	81	77	72	69	65	62	51	75
160	70	69	59	53	53	56	52	44	32	59
	360	81	72	68	65	66	62	55	44	70
	630	86	78	74	70	69	65	61	49	74
	900	91	83	79	74	71	67	64	53	77
180	90	70	60	54	54	58	53	45	33	61
	480	81	72	68	65	66	62	55	44	70
	840	86	78	74	70	69	65	61	49	74
	1200	92	84	80	75	72	68	65	54	78
200	115	71	61	55	55	59	54	46	34	62
	560	81	72	68	65	66	62	55	44	70
	980	86	78	74	70	69	65	61	49	74
	1400	92	84	80	75	72	68	65	54	78
225	145	72	62	56	56	60	55	47	35	63
	720	81	72	68	65	66	62	55	44	70
	1260	86	78	74	70	69	65	61	49	74
	1800	91	83	79	74	71	67	64	53	77
250	180	72	62	56	56	59	55	47	35	62
	880	80	71	67	64	65	61	54	43	69
	1540	85	77	73	69	68	64	60	48	73
	2200	91	83	79	74	71	67	64	53	77
280	220	73	64	58	58	60	57	49	37	64
	1120	82	73	68	67	66	63	56	45	71
	1960	86	78	74	70	69	65	61	49	74
	2800	92	84	80	75	72	68	65	54	78
315	280	75	65	59	59	63	58	50	38	66
	1400	83	74	70	67	68	65	58	47	72
	2450	87	80	76	72	71	66	63	50	76
	3500	93	85	81	76	73	69	66	55	79
355	355	77	67	61	61	65	60	52	50	68
	1800	85	76	72	69	70	66	59	48	74
	3150	90	82	78	74	73	69	65	53	78
	4500	94	86	82	77	74	70	67	56	80
400	455	79	69	63	63	66	61	53	41	69
	2320	86	77	73	70	71	67	60	49	75
	4060	90	82	78	74	73	69	65	53	78
	5800	94	86	82	77	74	70	67	56	80
500	710	78	67	60	60	63	60	53	41	66
	4200	88	79	75	72	73	69	62	51	77
	6300	92	84	80	76	75	71	67	55	80
	8500	96	88	84	79	76	72	69	58	82
630	1120	80	70	65	65	68	63	55	43	71
	6700	90	81	77	74	75	71	64	53	79
	10000	94	86	82	78	77	73	69	57	82
	13500	98	90	86	81	78	74	71	60	84

SERIE

RPM-V

DATOS TÉCNICOS



Nivel de potencia sonora L_{wa} (dB (A)) en el interior de la conducción

Ø 80

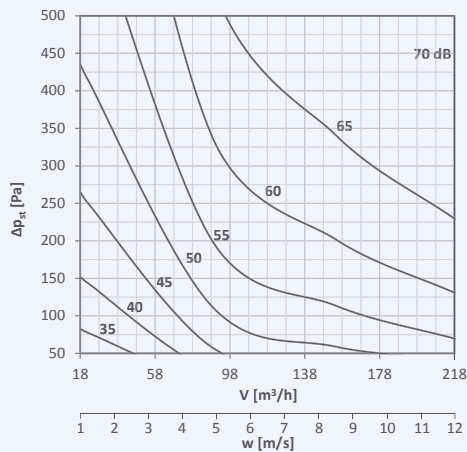

Ø 100

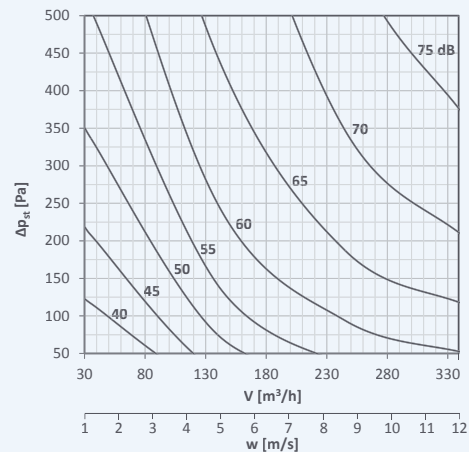

Ø 125

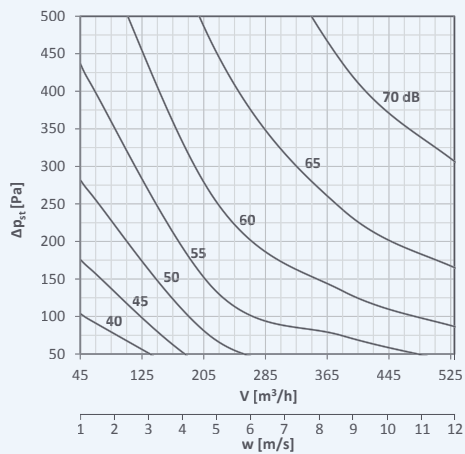

Ø 160

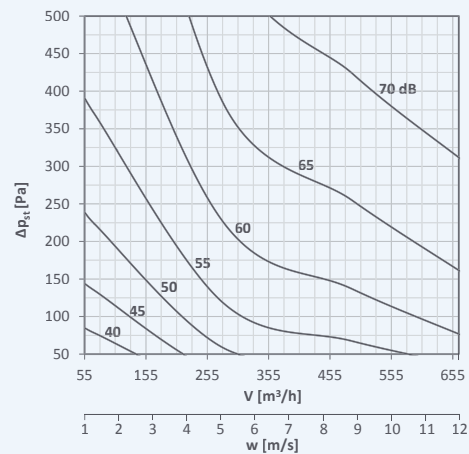

Ø 200

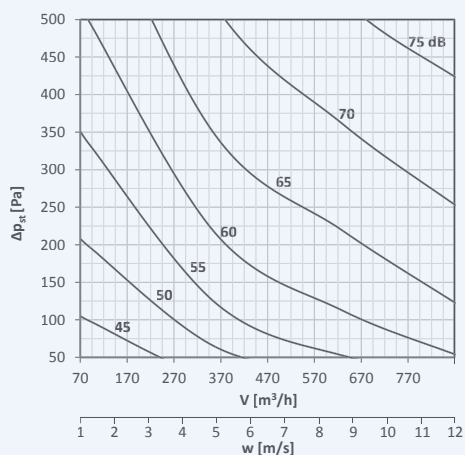

Ø 250

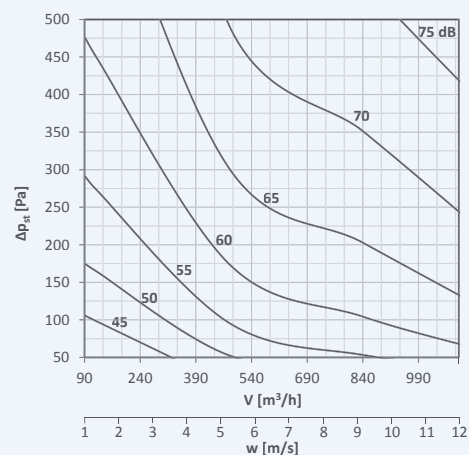

SERIE RPM-V

DATOS TÉCNICOS



Nivel de potencia sonora L_{wa} (dB (A)) en el interior de la conducción

Ø 200

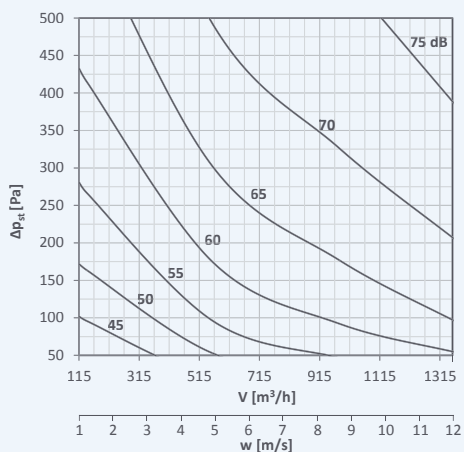

Ø 225

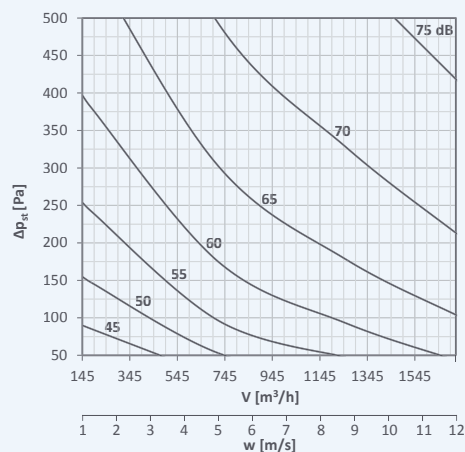

Ø 250

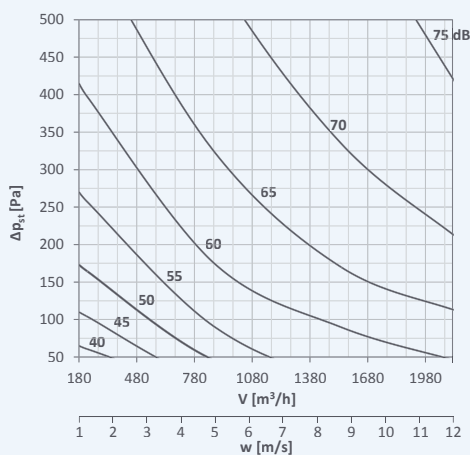

Ø 280

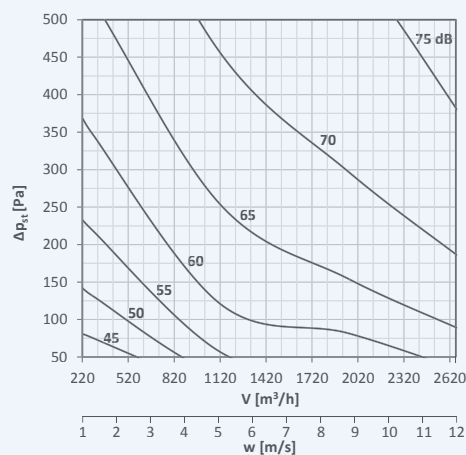

Ø 315

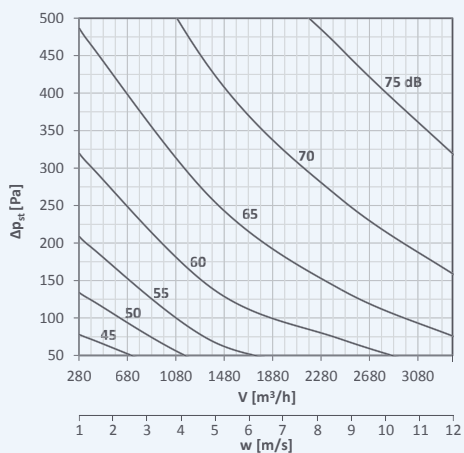

Ø 355

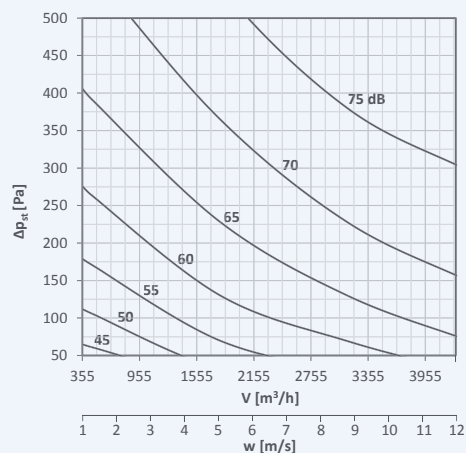

SERIE

RPM-V

DATOS TÉCNICOS



REGULACIÓN

Nivel de potencia sonora L_{wa} (dB (A)) en el interior de la conducción

Ø 400

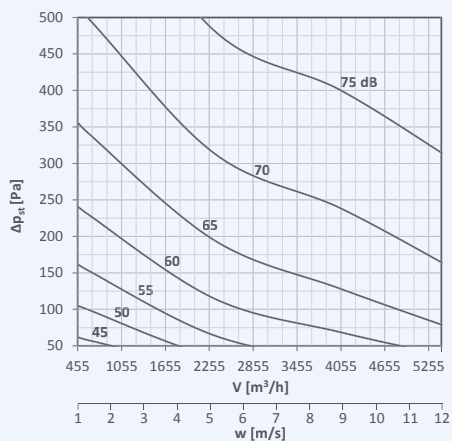

Ø 500

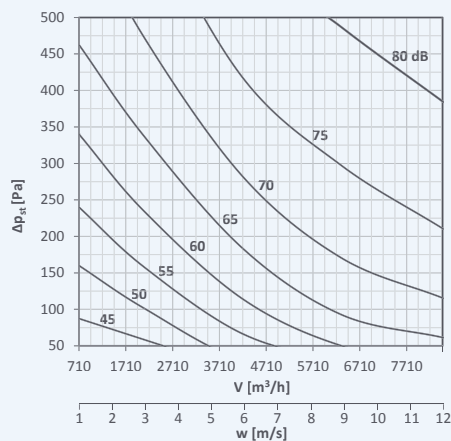

Ø 630

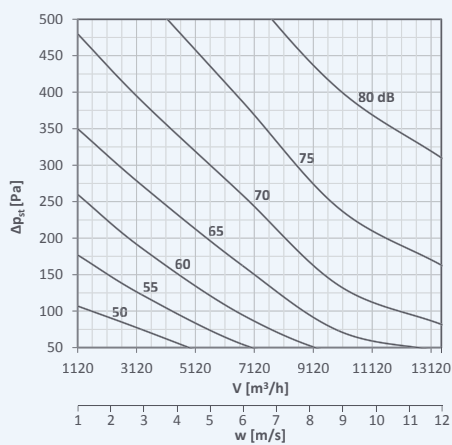

SERIE

RPM-V

DATOS TÉCNICOS



Nivel de potencia acústica radiada en el exterior de la tubería - sin aislamiento

El ruido radiado del controlador de volumen de aire se indica a continuación

V [m³h⁻¹] - volumen de flujo de aire
 ΔP_{st} [Pa] - presión diferencial

L_{WA} [dB(A)] - nivel total de potencia acústica
 corregido por el filtro A

Dimensión [mm]	V [m ³ /h]	L _{WA} [dB(A)]	L _{WA} [dB(A)]	L _{WA} [dB(A)]	L _{WA} [dB(A)]
		$\Delta P_{st}= 50$ Pa	$\Delta P_{st}= 100$ Pa	$\Delta P_{st}= 250$ Pa	$\Delta P_{st}= 500$ Pa
80	18	12	16	24	33
	88	24	29	38	47
	154	30	34	42	50
	220	35	39	47	54
100	30	14	18	27	37
	140	26	31	39	47
	245	33	38	45	52
	350	36	41	48	55
125	45	15	19	28	38
	220	27	33	41	49
	385	33	38	45	52
	550	37	42	49	56
140	55	18	23	31	39
	280	29	34	42	50
	490	34	39	46	53
	700	39	44	50	56
160	70	21	26	33	42
	360	30	35	43	51
	630	34	39	47	54
	900	39	44	51	57
180	90	21	25	33	42
	480	31	36	44	52
	840	35	40	48	56
	1200	40	45	52	59
200	115	22	27	34	43
	560	31	36	44	52
	980	35	40	48	55
	1400	41	45	52	58
225	145	23	28	38	46
	720	33	38	46	53
	1260	37	42	49	56
	1800	42	46	53	59
250	180	25	30	39	47
	880	36	40	47	53
	1540	40	44	51	57
	2200	44	48	54	60
280	220	28	33	43	51
	1120	37	42	50	56
	1960	42	46	54	60
	2800	45	50	57	63
315	280	30	34	44	53
	1400	39	44	52	59
	2450	44	48	56	62
	3500	47	51	59	65
355	355	29	34	44	54
	1800	39	44	52	60
	3150	44	49	56	63
	4500	48	53	60	66
400	455	30	36	46	54
	2320	38	44	53	61
	4060	44	49	57	64
	5800	50	54	61	67
500	710	31	36	47	55
	4200	45	50	59	66
	6300	51	56	64	70
	8400	55	60	67	73
630	1120	40	44	52	60
	6700	52	57	64	70
	10000	56	61	68	74
	13300	59	64	71	77

SERIE

RPM-V

DATOS TÉCNICOS



Nivel de potencia sonora L_{wa} (dB (A)) en el interior de la conducción - sin aislamiento

Ø 80

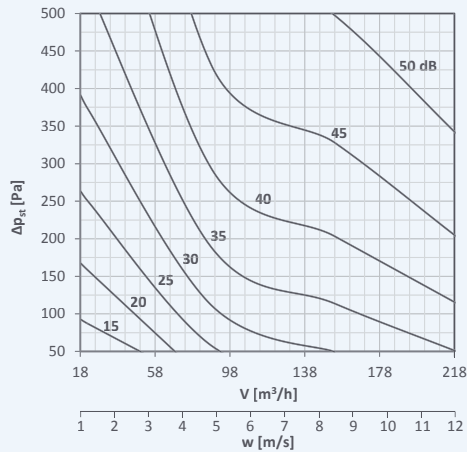

Ø 100

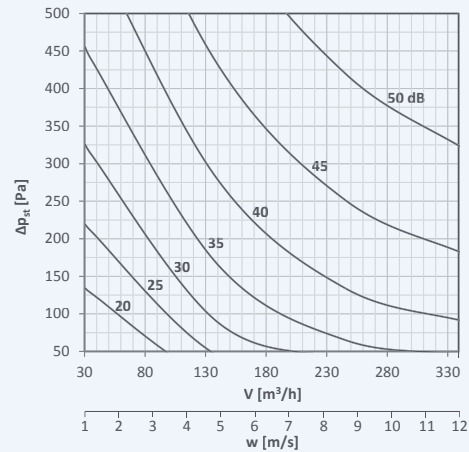

Ø 125

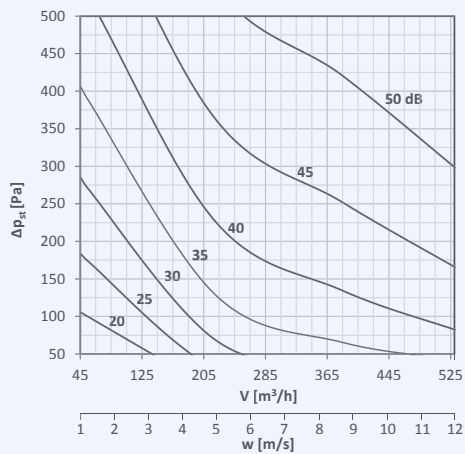

Ø 160

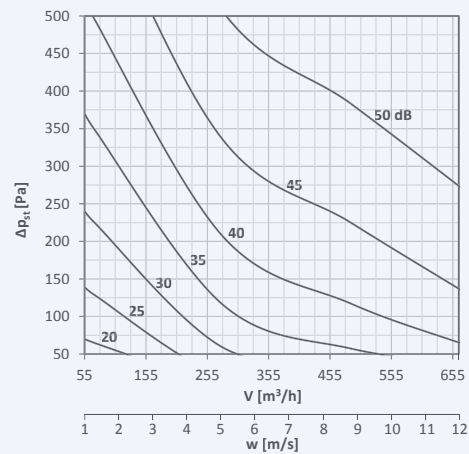

Ø 200

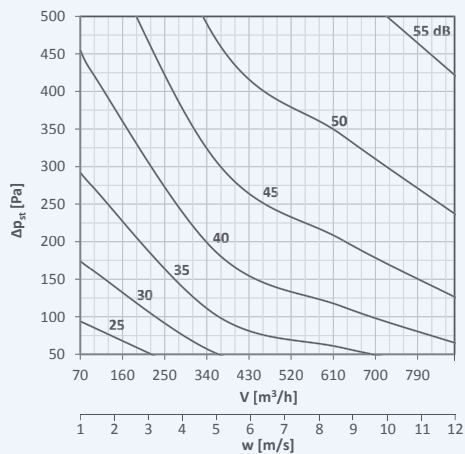

Ø 250

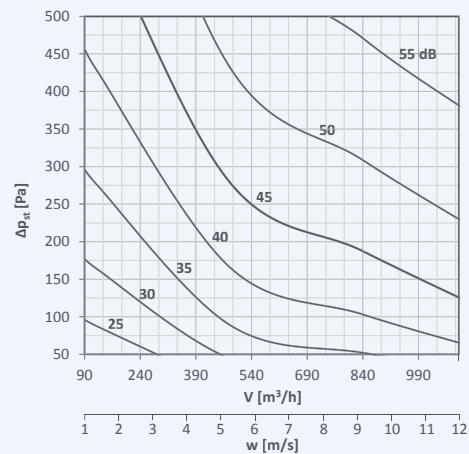

SERIE

RPM-V

DATOS TÉCNICOS



Nivel de potencia sonora L_{wa} (dB (A)) en el interior de la conducción - sin aislamiento

Ø 200

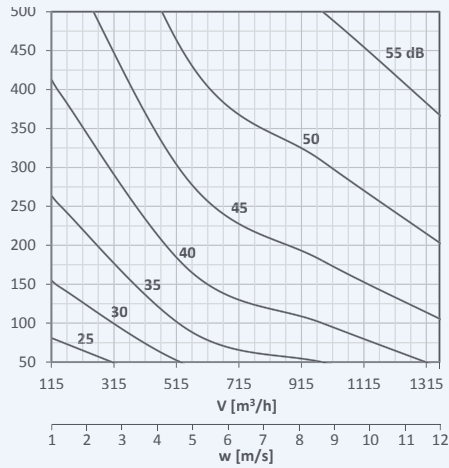

Ø 225

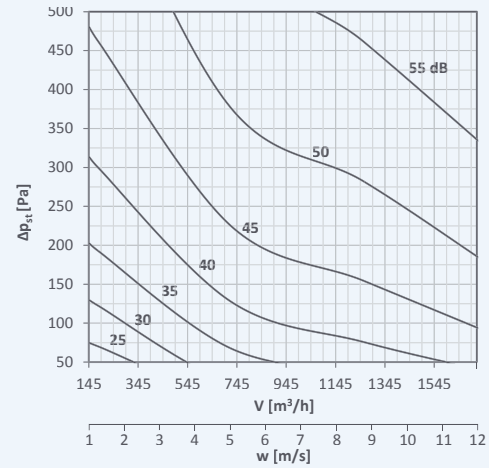

Ø 250

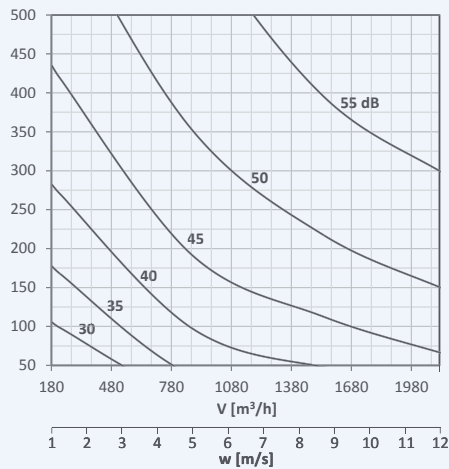

Ø 280

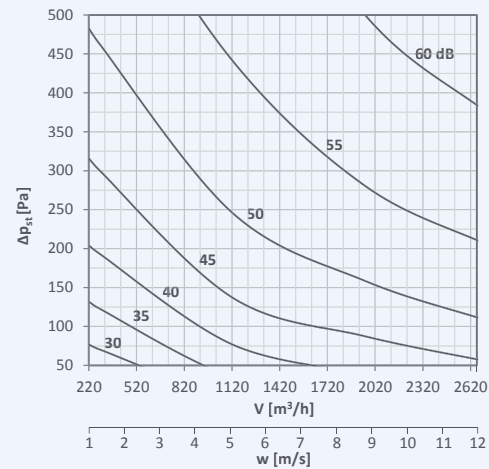

Ø 315

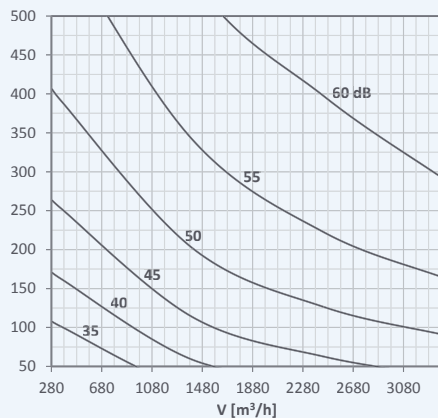

Ø 355

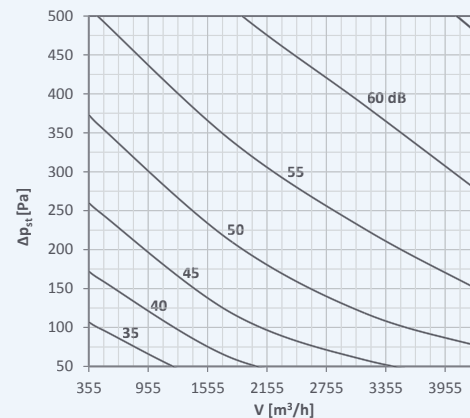

SERIE

RPM-V

DATOS TÉCNICOS



REGULACIÓN

Nivel de potencia sonora L_{wa} (dB (A)) en el interior de la conducción - sin aislamiento

Ø 400

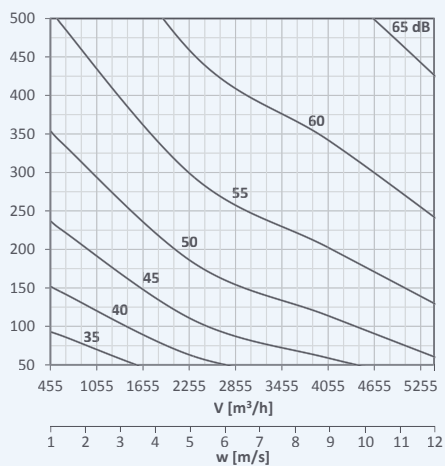

Ø 500

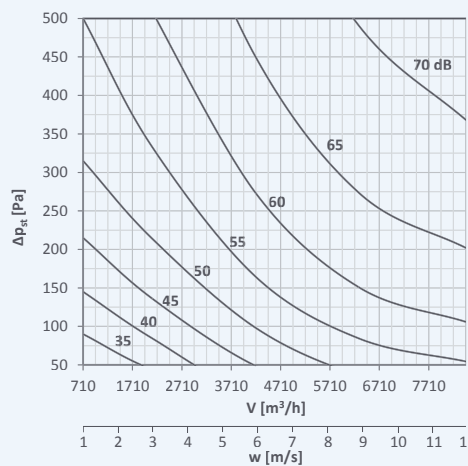

Ø 630

