

Contents

Safety Information	3
Safety Information	3
At a Glance	10
Indoor Unit Overview	10
Remote Control Overview	11
Basic Operation	13
Operation Modes	13
Advanced Operation	17
Setting the On or Off timer	17
Using the good'sleep Function	19
Using the Turbo Function	21
Using the Purity Function	22
Controlling Indoor Units	24
TDM (Time-Division Multi) Variables (TDM product Only)	25
Cleaning and Maintenance	26
Cleaning the Air Conditioner	26
Maintaining the Air Conditioner	29
Appendix	31
Troubleshooting	31
Operation Ranges	35
Technical specifications	36



***Correct Disposal of This Product
(Waste Electrical & Electronic Equipment)***

(Applicable in countries with separate collection systems)

This marking on the product, accessories or literature indicates that the product and its electronic accessories (e.g. charger, headset, USB cable) should not be disposed of with other household waste at the end of their working life. To prevent possible harm to the environment or human health from uncontrolled waste disposal, please separate these items from other types of waste and recycle them responsibly to promote the sustainable reuse of material resources.

Household users should contact either the retailer where they purchased this product, or their local government office, for details of where and how they can take these items for environmentally safe recycling.

Business users should contact their supplier and check the terms and conditions of the purchase contract. This product and its electronic accessories should not be mixed with other commercial wastes for disposal.

For information on Samsung's environmental commitments and product specific regulatory obligations e.g. REACH visit: samsung.com/uk/aboutsamsung/samsungelectronics/corporatecitizenship/data_corner.html

Safety Information

Before using your new air conditioner, please read this manual thoroughly to ensure that you know how to safely and efficiently operate the extensive features and functions of your new appliance.





Because the following operating instructions cover various models, the characteristics of your air conditioner may differ slightly from those described in this manual. If you have any questions, call your nearest contact centre or find help and information online at www.samsung.com.

WARNING

Hazards or unsafe practices that may result in severe personal injury or death.

CAUTION

Hazards or unsafe practices that may result in minor personal injury or property damage.

-  Follow directions.
-  Do NOT attempt.
-  Make sure the machine is grounded to prevent electric shock.
-  Cut-off the power supply.
-  Do NOT disassemble.

FOR INSTALLATION

WARNING

 **Use the power line with the power specifications of the product or higher and use the power line for this appliance only. In addition, do not use an extension line.**

- Extending the power line may result in electric shock or fire.
- Do not use an electric transformer. It may result in electric shock or fire.
- If the voltage/frequency/rated current condition is different, it may cause fire.

Safety Information

The installation of this appliance must be performed by a qualified technician or service company.

- Failing to do so may result in electric shock, fire, explosion, problems with the product, or injury.

Install a switch and circuit breaker dedicated to the air conditioner.

- Failing to do so may result in electric shock or fire.

Fix the outdoor unit firmly so that the electric part of the outdoor unit is not exposed.

- Failing to do so may result in electric shock or fire.

⊘ Do not install this appliance near a heater, inflammable material. Do not install this appliance in a humid, oily or dusty location, in a location exposed to direct sunlight and water (rain drops). Do not install this appliance in a location where gas may leak.

- This may result in electric shock or fire.

Never install the outdoor unit in a location such as on a high external wall where it could fall.

- If the outdoor unit falls, it may result in injury, death or property damage.

⚡ This appliance must be properly grounded. Do not ground the appliance to a gas pipe, plastic water pipe, or telephone line.

- Failure to do so may result in electric shock, fire, an explosion, or other problems with the product.
- Never plug the power cord into a socket that is not grounded correctly and make sure that it is in accordance with local and national codes.

⚠ CAUTION**❗ Install your appliance on a level and hard floor that can support its weight.**

- Failing to do so may result in abnormal vibrations, noise, or problems with the product.

Install the draining hose properly so that water is drained correctly.

- Failing to do so may result in water overflowing and property damage. Avoid adding drain to waste pipes as odours may arise in the future.

When installing the outdoor unit, make sure to connect the draining hose so that draining is performed correctly.

- The water generated during the heating operation by the outdoor unit may overflow and result in property damage. In particular, in winter, if a block of ice falls, it may result in injury, death or property damage.

FOR POWER SUPPLY

⚠ WARNING**❗ When the circuit breaker is damaged, contact your nearest service centre.**

- ⊘ **Do not pull or excessively bend the power line. Do not twist or tie the power line. Do not hook the power line over a metal object, place a heavy object on the power line, insert the power line between objects, or push the power line into the space behind the appliance.**

- This may result in electric shock or fire.

⚠ CAUTION**⚡ When not using the air conditioner for a long period of time or during a thunder/lightning storm, cut the power at the circuit breaker.**

- Failing to do so may result in electric shock or fire.

Safety Information

FOR USING

WARNING

! If the appliance is flooded, please contact your nearest service centre.

- Failing to do so may result in electric shock or fire.

If the appliance generates a strange noise, a burning smell or smoke, unplug the power plug immediately and contact your nearest service centre.

- Failing to do so may result in electric shock or fire.

In the event of a gas leak (such as propane gas, LP gas, etc.), ventilate immediately without touching the power line. Do not touch the appliance or power line.

- Do not use a ventilating fan.
- A spark may result in an explosion or fire.

To reinstall the air conditioner, please contact your nearest service centre.

- Failing to do so may result in problems with the product, water leakage, electric shock, or fire.
- A delivery service for the product is not provided. If you reinstall the product in another location, additional construction expenses and an installation fee will be charged.
- Especially, when you wish to install the product in an unusual location such as in an industrial area or near the seaside where it is exposed to the salt in the air, please contact your nearest service centre.

⊘ Do not touch the circuit breaker with wet hands.

- This may result in electric shock.

Do not turn the air conditioner off with the circuit breaker while it is operating.

- Turning the air conditioner off and then on again with the circuit breaker may cause a spark and result in electric shock or fire.

After unpacking the air conditioner, keep all packaging materials well out of the reach of children, as packaging materials can be dangerous to children.

- If a child places a bag over its head, it may result in suffocation.

Do not touch the front panel with your hands or fingers during the heating operation.

- This may result in electric shock or burns.

Do not insert your fingers or foreign substances into the outlet when the air conditioner is operating or the front panel is closing.

- Take special care that children do not injure themselves by inserting their fingers into the product.

Do not insert your fingers or foreign substances into the air inlet/outlet of the air conditioner.

- Take special care that children do not injure themselves by inserting their fingers into the product.

Do not strike or pull the air conditioner with excessive force.

- This may result in fire, injury, or problems with the product.

Do not place an object near the outdoor unit that allows children to climb onto the machine.

- This may result in children seriously injuring themselves.

Do not use this air conditioner for long periods of time in badly ventilated locations or near infirm people.

- Since this may be dangerous due to a lack of oxygen, open a window at least once an hour.

 **If any foreign substance such as water has entered the appliance, cut the power by unplugging the power plug and turning the circuit breaker off and then contact your nearest service centre.**

- Failing to do so may result in electric shock or fire.

 **Do not attempt to repair, disassemble, or modify the appliance yourself.**

- Do not use any fuse (such as copper, steel wire, etc.) other than the standard fuse.
- Failing to do so may result in electric shock, fire, problems with the product, or injury.

Safety Information

CAUTION

Do not place objects or devices under the indoor unit.

- Water dripping from the indoor unit may result in fire or property damage.

Check that the installation frame of the outdoor unit is not broken at least once a year.

- Failing to do so may result in injury, death or property damage.

Max current is measured according to IEC standard for safety and current is measured according to ISO standard for energy efficiency.

Do not stand on top of the appliance or place objects (such as laundry, lighted candles, lighted cigarettes, dishes, chemicals, metal objects, etc.) on the appliance.

- This may result in electric shock, fire, problems with the product, or injury.

Do not operate the appliance with wet hands.

- This may result in electric shock.

Do not spray volatile material such as insecticide onto the surface of the appliance.

- As well as being harmful to humans, it may also result in electric shock, fire or problems with the product.

Do not drink the water from the air conditioner.

- The water may be harmful to humans.

Do not apply a strong impact to the remote controller and do not disassemble the remote controller.

Do not touch the pipes connected with the product.

- This may result in burns or injury.

Do not use this air conditioner to preserve precision equipment, food, animals, plants or cosmetics, or for any other unusual purposes.

- This may result in property damage.

Avoid directly exposing humans, animals or plants from the air flow from the air conditioner for long periods of time.

- This may result in harm to humans, animals or plants.

This appliance is not intended for use by persons (including children) with reduced physical, sensory or mental capabilities, or lack of experience and knowledge, unless they have been given supervision or instruction concerning use of the appliance by a person responsible for their safety. Children should be supervised to ensure that they do not play with the appliance.

For use in Europe: This appliance can be used by children aged from 8 years and above and persons with reduced physical, sensory or mental capabilities or lack of experience and knowledge if they have been given supervision or instruction concerning use of the appliance in a safe way and understand the hazards involved. Children shall not play with the appliance. Cleaning and user maintenance shall not be made by children without supervision.

FOR CLEANING



WARNING

-  **Do not clean the appliance by spraying water directly onto it. Do not use benzene, thinner, alcohol or acetone to clean the appliance.**
 - This may result in discoloration, deformation, damage, electric shock or fire.

Before cleaning or performing maintenance, unplug the air conditioner from the wall socket and wait until the fan stops.

- Failing to do so may result in electric shock or fire.

CAUTION

-  **Take care when cleaning the surface of the heat exchanger of the outdoor unit since it has sharp edges.**
 - To avoid cutting your fingers, wear thick cotton gloves when cleaning it.
 - This should be done by a qualified technician please contact your installer or service centre.
-  **Do not clean the inside of the air conditioner by yourself.**
 - For cleaning inside the appliance, contact your nearest service centre.
 - When cleaning the internal filter, refer to the descriptions in the 'Cleaning and Maintaining' section.
 - Failure to do may result in damage, electric shock or fire.

Indoor Unit Overview

Main parts

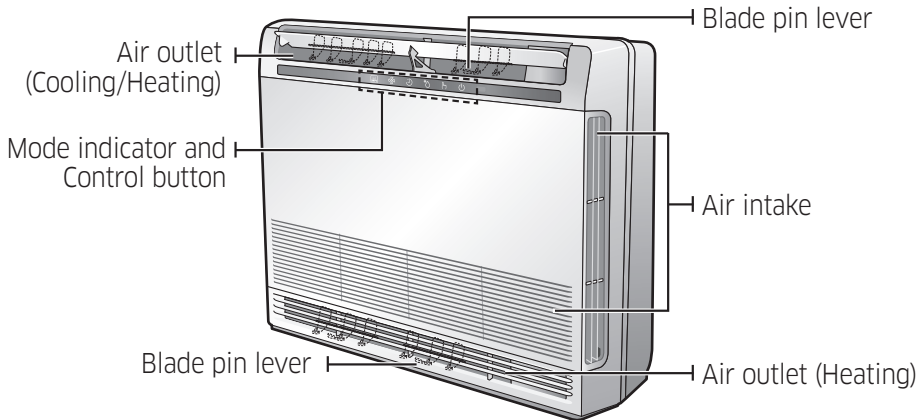

Display

Mode indicator and Control button

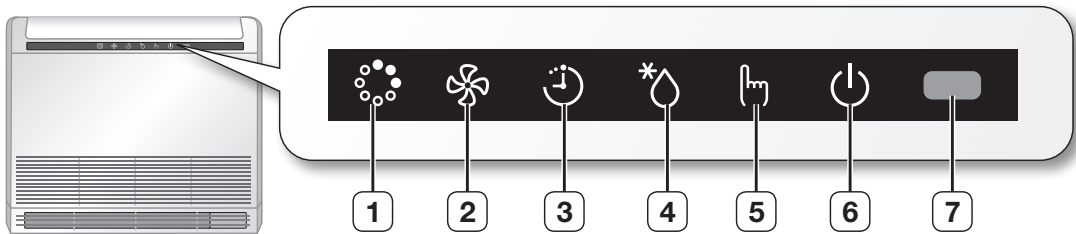

1 VIRUS DOCTOR INDICATOR		Virus doctor icon will light up when Virus doctor is operating.
2 FAN MODE INDICATOR		This icon will light up when the unit is operating in Fan mode.
3 TIMER INDICATOR		Timer icon will light up when On/Off Timer function is set.
4 DEICE INDICATOR		This icon will light up when the unit starts to de-ice.
5 POWER BUTTON		Turn On/Off the air conditioner. The air conditioner will operate in Auto mode.
6 POWER INDICATOR		Power icon will light up when the unit is in operation.
7 REMOTE CONTROL SENSOR		Aim the remote control toward this spot on the air conditioner.

NOTE

- Your air conditioner and display may look slightly different from the illustration shown above depending on your model.
- Each time you press the button, a short beep will sound and the unit is properly operating.

Remote Control Overview

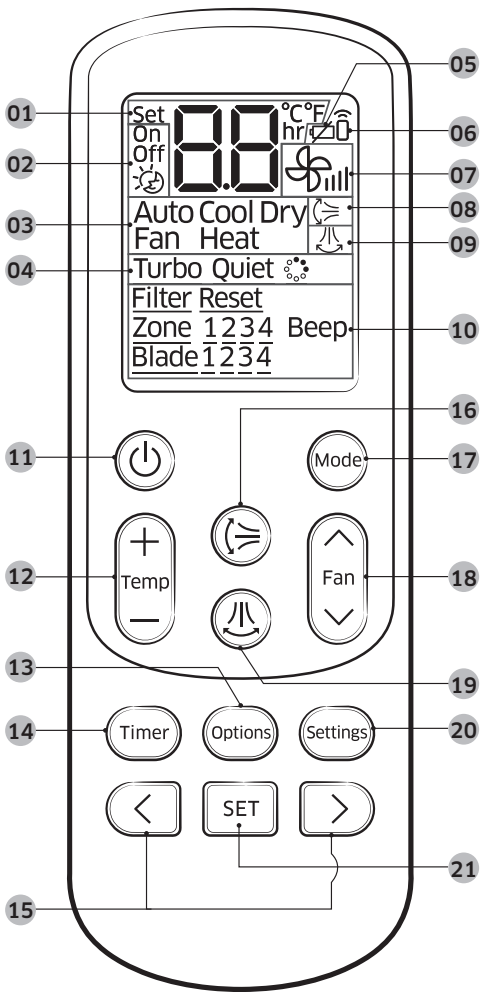

- 01 Set temperature indicator
- 02 Timer option indicator
- 03 Operation mode indicator
- 04 Options indicator
- 05 Low battery indicator
- 06 Transmit indicator

- 07 Fan speed indicator
- 08 Vertical air swing indicator
- 09 Horizontal air swing indicator

NOTE

- This function is not available in this model.

- 10 Settings indicator
- 11 Power button
- 12 Temperature button
- 13 Options button
- 14 Timer button
- 15 Direction button/Selection button
- 16 Vertical air swing button
- 17 Mode button
- 18 Fan speed button
- 19 Horizontal air swing button

NOTE

- This function is not available in this model.

- 20 Settings button
- 21 SET button

NOTE

- The air conditioner may not be operated by the remote control if the controller is placed close to strong light such as a fluorescent lamp or neon sign. In this case, use the remote control right in front of the remote control receiver of the indoor unit.
- If other electrical products are operated by the remote control, call your nearest service center.
- To silence the beep sound, press the **Settings** → <, > or **Settings** → (Beep) blinking → **SET** button. When you press the **Settings** → <, > or **Settings** → (Beep) blinking → **SET** button again, the beep sound will be active again.

Remote Control Overview

Replacing batteries

When the  icon appears in the remote control display, replace the batteries with new ones. Two 1.5V AAA type batteries are required.

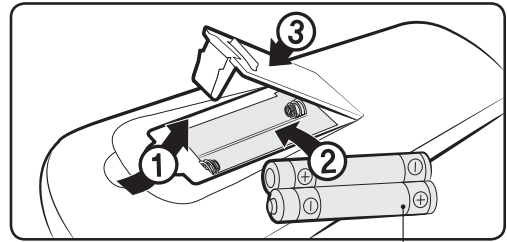

two 1.5V AAA type batteries



Correct disposal of batteries in this product

(Applicable in countries with separate collection systems)

This marking on the battery, manual or packaging indicates that the batteries in this product should not be disposed of with other household waste at the end of their working life. Where marked, the chemical symbols Hg, Cd or Pb indicate that the battery contains mercury, cadmium or lead above the reference levels in EC Directive 2006/66.

Storing the remote control

If the remote control will not be used for an extended period of time, store it in the remote control holder with the batteries removed.

CAUTION

- Make sure that water does not come into the remote control.

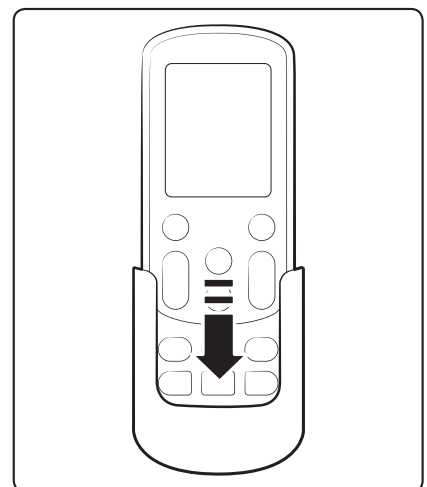

Operation Modes

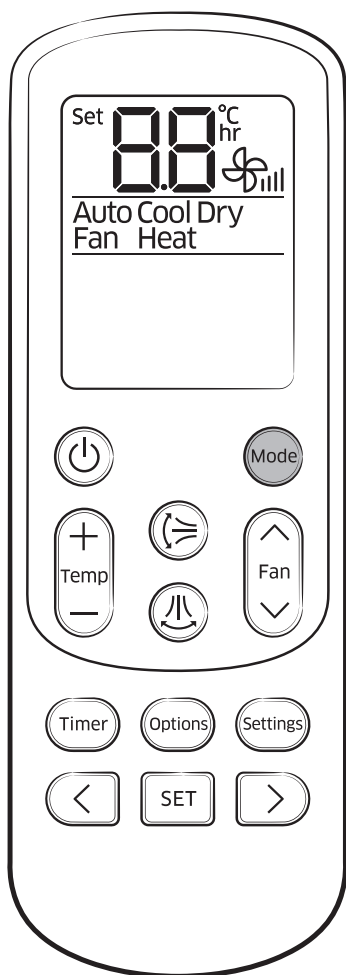

Auto

In Auto mode, the air conditioner will automatically adjust the temperature and fan speed to maintain your fresh environment.

- When the indoor temperature is too high, the powerful cool breeze is generated and when the indoor room becomes cool enough, the soft breeze is generated.

Cool

The Cool mode is frequently used and you can freely control the temperature, fan speed, and air flow direction in Cool mode.

- When you select the Heat mode while the Cool mode is on, the Cool mode is cancelled.

Dry

The air conditioner in Dry mode acts like a dehumidifier by removing moisture from the indoor air. The Dry mode will provide you with fresh air even on a rainy day.

Fan

The Fan mode provides you with a breeze just like a fan to make fresh environment for you.

Operation Modes

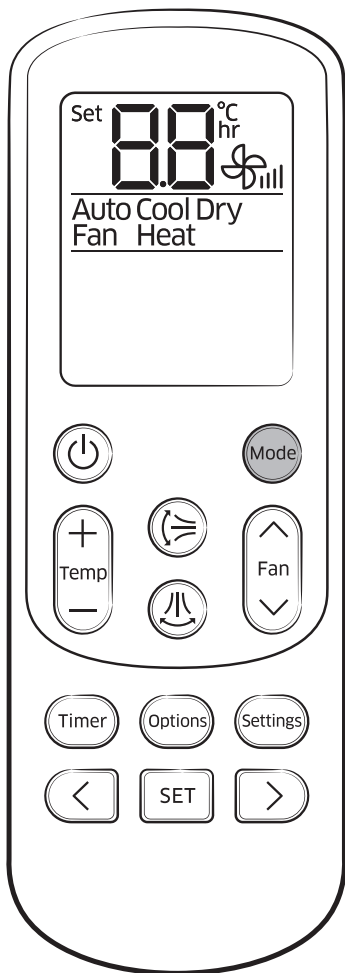

Heat

In Heat mode, you can warm your room even in fall and winter.

- The fan may not commence immediately to avoid generating a cold breeze.
- In Heat mode, defrost operation may be performed to remove the frost formed on the outdoor unit. (When the frost is removed by the defrost operation in Heat mode, steam is generated from the outdoor unit.)
- If you stop operating the air conditioner after heating operation, the fan will operate for some time to cool the indoor unit.
- When you select the Cool mode while the Heat mode is on, the Heat mode is cancelled.

NOTE

- When the outdoor temperature is relatively low and the humidity is relatively high in Heat mode, the outdoor unit's heating capacity may decrease due to the frost formed on the outdoor heat exchanger. The defrost operation removes the frost formed on the heat exchanger of the outdoor unit for 5 to 12 minutes. During the defrost operation, the indoor unit does not generate breeze in order to prevent cold breeze blowing out.
 - The interval between defrost operations can decrease depending on the amount of the frost formed on the outdoor unit.
 - The interval between defrost operations can also decrease depending on the humidity level in the air.

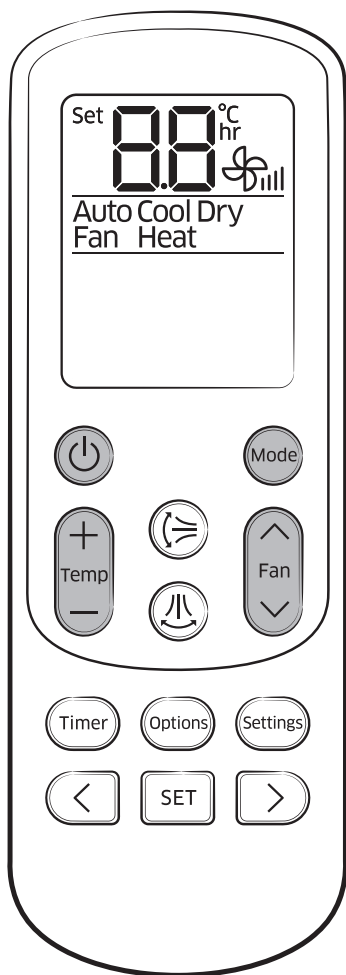

Turning the air conditioner on

Press the  button to operate the air conditioner.

Selecting the operation mode

Press the  button to select an operation mode.

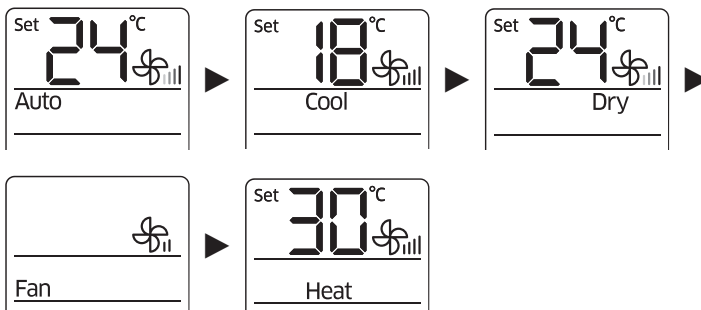









Adjusting the temperature

Press the  button to adjust the temperature.

Mode	Temperature control
Auto/Cool/ Dry	Adjust by 1 °C between 18 °C and 30 °C.
Heat	Adjust by 1 °C between 16 °C and 30 °C.
Fan	Temperature cannot be adjusted.

Selecting the fan speed

Press the  button to adjust the fan speed.

Mode	Available fan speeds
Auto/Dry	 (Auto)
Cool/Heat	 (Auto),  (Low),  (Med),  (High)
Fan	 (Low),  (Med),  (High)

Operation Modes

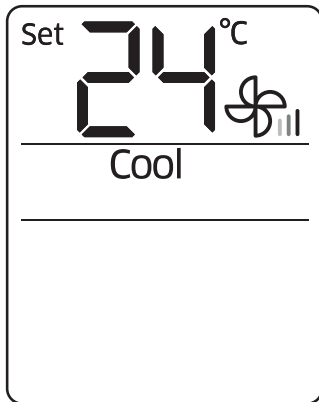
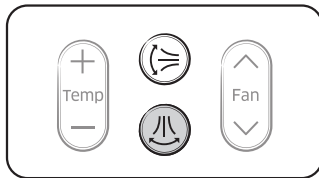

Remote control display

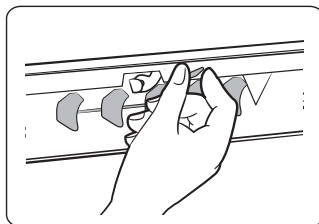

Selecting air flow direction

Keep the air flow in a constant direction by stopping the movements of the vertical and horizontal air flow blades.

In operation ► 

NOTE

- If you adjust the vertical air flow blade manually, it may not close completely when you turn off the air conditioner.

Horizontal air flow (manual)

Keep the horizontal air flow in a constant direction by changing the directions of the horizontal air flow blades manually.

NOTE

- Although you press the  button, this function does not work.

CAUTION

- To prevent personal injury, make sure that you change the directions of the horizontal air flow blades after stopping the movements of the vertical air flow blade.

Setting the On or Off timer

The actual product may differ slightly from the image depicted below.

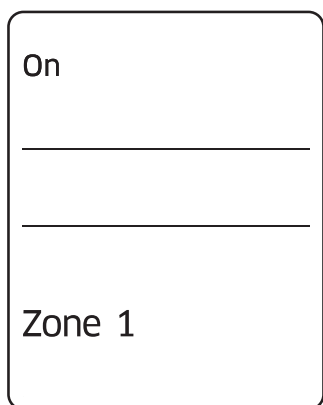
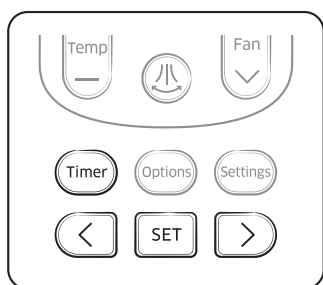

Remote control display

Setting the On timer

When the air conditioner is turned off:

1. Press the **Timer** button to select (On).
 - The (On) indicator will keep blinking and you can set the time.
2. Press the **<** or **>** button to set the time.
 - You can set the time in half hour intervals from 30 minutes (0.5 on the display) to 3 in hour intervals from 3 to 24 hours.
 - The time can be set from minimum 30 minutes to maximum 24 hours.
3. Press the **SET** button to complete the On timer setting.
 - The (On) indicator and the set time of the timer will be displayed on the remote control display.
 - On timer setting will be cancelled if you don't press the **SET** button within 10 seconds after setting the time. Therefore, check for the (On) indicator on the remote control display.

Cancel	Press the Timer button ► select (On) ► press the < or > button ► set the timer to 00 ► press the SET button
---------------	--

Additional options available in the On timer	
	Select the mode in the following order: (Auto) ► (Cool) ► (Dry) ► (Fan) and ► (Heat).
	You can adjust the temperature after timer setting is completed. Temperature adjustment is only available in Auto, Cool, Dry, and Heat modes. In Fan mode, the temperature cannot be adjusted.

NOTE

- When On timer setting is completed, the setting will be displayed for 3 seconds, and then only the (On) indicator will remain on the remote control display.
- You cannot set the Fan speed when setting the On timer.

Setting the On or Off timer

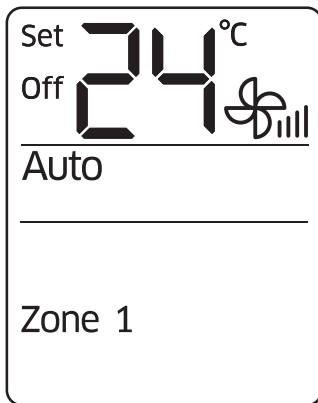
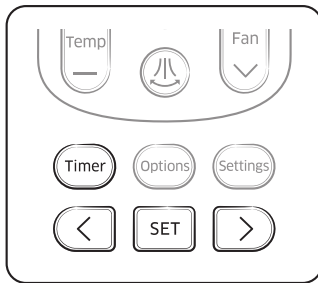

Remote control display

Setting the Off timer

When the air conditioner is turned on:

1. Press the **Timer** button to select (Off).
 - The (Off) indicator will keep blinking and you can set the time.
2. Press the **<** or **>** button to set the time.
 - You can set the time in half hour intervals from 30 minutes (0.5 on the display) to 3 hours and in hour intervals from 3 to 24 hours.
 - The time can be set from minimum 30 minutes to maximum 24 hours.
3. Press the **SET** button to complete the Off timer setting.
 - The (Off) indicator and the set time of the timer will be displayed on the remote control display.
 - Off timer setting will be cancelled if you don't press the **SET** button within 10 seconds after setting the time. Therefore, check for the (Off) indicator on the remote control display.

Cancel	Press the Timer button ► select (Off) ► press the < or > button ► set the timer to 00 ► press the SET button
--------	---

NOTE

- Only the latest timer setting will be applied between the Off timer and good' sleep off timer functions.

Combining On timer and Off timer	
When the air conditioner is turned off	When the air conditioner is turned on
When the set time on On timer is less than that on Off timer e.g. On timer: 3 hours, Off timer: 5 hours	When the set time on On timer is greater than that on Off timer e.g. On timer: 3 hours, Off timer: 1 hour
<ul style="list-style-type: none"> • The air conditioner will be turned on after 3 hours from the moment you have set the timer and the air conditioner will remain on for 2 hours and then be turned off automatically. 	<ul style="list-style-type: none"> • The air conditioner will be turned off after 1 hour from the moment you have set the timer and will be automatically turned on after 2 hours from the moment it was turned off.

NOTE

- The set times for the On timer and the Off timer should be different from each other.
- After the On timer or the Off timer is set, the setting can be cancelled by pressing the **Power** button.

Setting the good'sleep mode

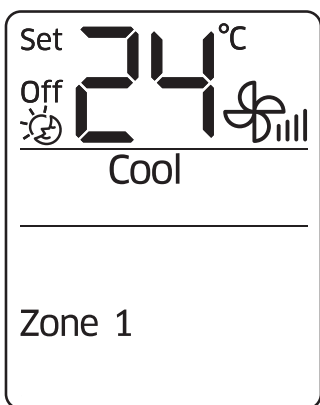
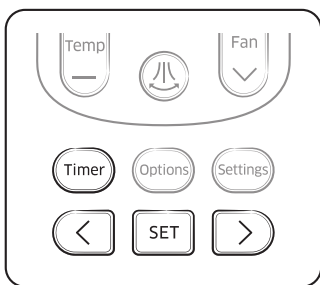

Remote control display

When the air conditioner is operating in **Cool** mode;

1. Press the **Timer** button to select .
 - The () indicator will keep blinking and you can set the time.
2. Press the **<** or **>** button to set the time.
 - You can set the time in half hour intervals from 30 minutes (0.5 on the display) to 3 hours and in hour intervals from 3 to 12 hours.
 - The time can be set from minimum 30 minutes to maximum 12 hours.
 - The default time value for the good'sleep mode is 8 hours.
3. Press the **SET** button to complete the good'sleep mode setting.
 - The () indicator and the set time of the good'sleep mode will be displayed on the remote control display.
 - The good'sleep mode will be cancelled if you don't press the **SET** button within 10 seconds after setting the time. Therefore, check for the () indicator on the remote control display.

Cancel	Press the Timer button ► select () ► press the < or > button ► set the timer to 00 ► press the SET button
---------------	--

Additional options available in good'sleep mode





	The temperature can be adjusted by 1 °C (1 °F) within the range of 18 °C (65 °F) to 30 °C (86 °F).
--	--

Using the good'sleep Function

For a comfortable sleep, the air conditioner will operate in order of 'Fall asleep ► Sound sleep ► Wake up' stages.

- Fall asleep mode: Provides you with comfortable environment for a good sleep by rapid cooling and hypnagogue expedition breeze.
- Sound sleep mode: The sound sleep mode adjusts temperature and air flow in waves to maintain healthy skin temperature while it aids deep sleep. According to the change of good' sleep operation hours, the sound sleep hour can increase or decrease.
- Wake up from good'sleep mode: Provides you with the air flow that adjusts your body temperature to wake you up in a fresh status.

NOTE

- In good'sleep mode, the air conditioner will operate in Cool + () mode for first 30 minutes. The fan speed and air flow direction will be adjusted automatically in good'sleep mode.
- Recommended set temperature is between 25 °C (77 °F) and 27 °C (81 °F) and the value 26 °C (79 °F) is the most ideal temperature.
- If the set temperature is too low, you may feel cold while sleeping or catch a cold.
- Optimal operation time in good'sleep mode is 8 hours. Therefore, if the time is set too short or long, you may not feel as comfortable as you want.
- If the good'sleep mode is set over 5 hours, The Wake up stage will begin when 1 hour is remaining in the operation time and the air conditioner will stop automatically.
- When the On timer and the good'sleep mode are set simultaneously, the air conditioner will only apply the function that was set later.
- While the good'sleep mode is operating, the  mode can be set additionally by pressing the  button.
- If you press the  button and select the Turbo/Quiet function, the good'sleep mode will be cancelled and the selected mode will begin operation.
- If you press the  button, the good'sleep mode will be cancelled and the selected mode will begin operation.

Using the Turbo Function

You can set the Turbo function to provide fast and powerful cooling.

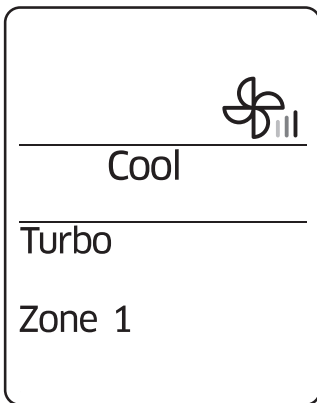
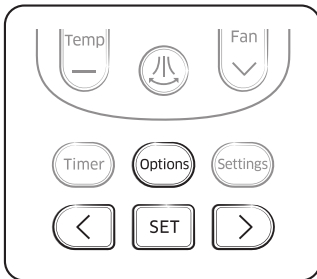

Remote control display

When the air conditioner is operating in Cool mode;

1. Press the **Options** button.
2. Press the **<**, **>** or **Options** button until the (Turbo) indicator starts blinking.
3. Press the **SET** button to set the Turbo function.
 - The (Turbo) indicator will be displayed on the remote control display and Turbo function will operate for 30 minutes.

Cancel	Press the Options button ► press the < , > or Options to make the (Turbo) indicator blink and press the SET button.
---------------	--

NOTE

- Turbo function is available in Cool or Heat mode.
- If the Turbo function is selected while the Quiet function is on, the Quiet function will be cancelled.
- The temperature and fan speed cannot be adjusted.

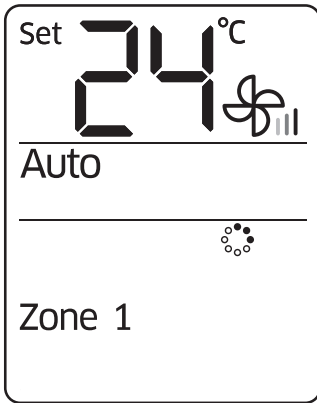
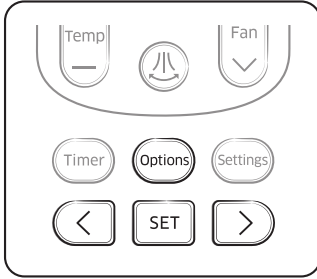

Using the Purity function

Purity function will remove harmful materials in the air to provide you clean and healthy environment. You can select this function additionally while the air conditioner is in operation.



Remote control display

When the air conditioner is turned on

1. Press the **Options** button.
2. Press the **<**, **>** or **Options** button until the () indicator starts blinking.
3. Press the **SET** button to set the Purity function.
 - () → () indicator will be displayed on the remote controller display and Virus Doctor function will begin.

Cancel	Press the Options button ► press the < , > or Options to make the () indicator blink and press the SET button.
--------	--

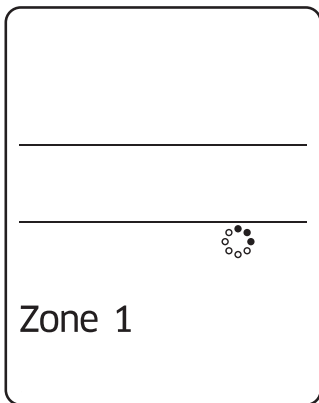
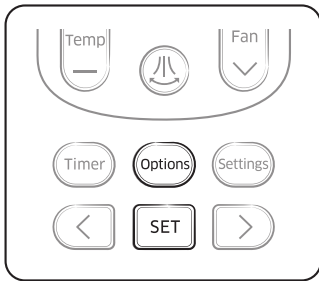

NOTE

- You may select the purity function additionally during Auto/Cool/Dry/Heat mode and you can adjust the temperature.
- If the purity function is selected additionally in fan mode, the temperature cannot be adjusted.
- When the air conditioner and the purity function are turned on simultaneously and you press the Power button, both air conditioner and purity function will stop operation.
- You can still use the purity function when the On timer is set with the air conditioner is turned off.
- There will not be much difference on energy consumption and operating noise when the purity function is selected additionally while the air conditioner is turned on.



Remote control display

When the air conditioner is turned off

1. Press the **Options** button.
2. Press the **SET** button when () indicator blinks to begin purity function.
 - () → () indicator will be displayed on the remote controller display and Virus Doctor function will begin.

Cancel	Press the Options button to make the () indicator blink and press the SET button.
---------------	--

Controlling Indoor Units

You can individually select and operate indoor units among 4 indoor units.

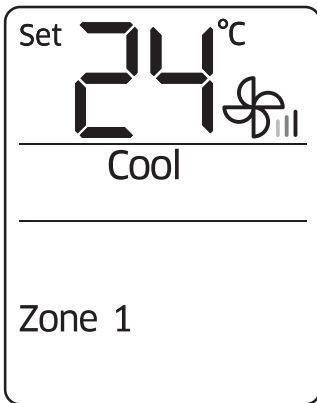
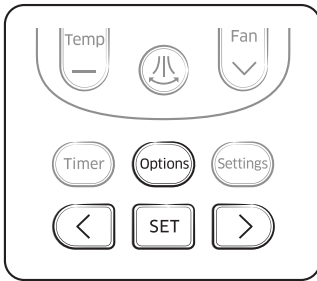

Remote control display

When the air conditioner is turned on:

1. Press the **Settings** button.
2. Press the **<**, **>** or **Settings** button until the (Zone) indicator starts blinking.
3. Press the **SET** button to select the indoor unit to operate.
 - You can select individual units in order of 1 to 4 or select all indoor units at one time.

TDM (Time-Division Multi) Variables (TDM product Only)

- Under the installation of both A2A (Air-To-Air type air conditioner) and A2W (Air-To-Water type hydro unit) at the same time, our outdoor machine can supply its full capacity to the operating indoor machines (including A2A or A2W). If there are simultaneous operating demands from many A2A machines with A2W, the priority of controlling the outdoor machine (ex: compressor frequency) will be given to A2A, because of their fast response for use's comfort. Only the remaining capacity of outdoor machine will be given to A2W during A2A's normal operation. In this case, it might take very long time for A2W heating, so the outdoor machine will alternate the controlling priorities between A2A and A2W with time basis.
- Priority maximum operation time (at FSV #5033=0): FSV #5031 (Default "30 min.", Range 10 ~ 90 min.), After elapsing A2A maximum time, the outdoor machine will operate only for A2W to speed up the A2W's heating/cooling performance, even though there are A2A's continuous operation demands.
- Non priority minimum operation time (at FSV #5033=0): FSV #5032(Default "5 min.", Range 3 ~ 60 min.), in this minimum time, the outdoor machine will operate only for A2W, even though there are no more A2W's continuous operation demands.

<Operating specifications of Time Division Switching (TDS) in accordance with FSV #5033 setting (In case of the A2A & A2W simultaneous operation is "ON")>				
FSV setting	A2A Cooling + A2W Cooling	A2A Cooling + A2W Heating	A2A Heating + A2W Cooling	A2A Heating + A2W Heating
A2A Priority (#5033=0)	A2A Cooling A2W Cooling "Same cooling Mode TDS Control"	A2A Cooling A2W Cycle Off (The heater just operates without heating.) "Cooling Operation"	A2A Heating A2W x (Not operation) "Heating Operation"	A2A Heating A2W Heating "Same heating Mode TDS Control"
DHW Priority (#5033=1)	Same with A2A Priority setting	A2W Heating A2A Cooling "(Heating + Cooling) TDS Control"	Same with A2A Priority setting	Same with A2A Priority setting

※ A2A : Air to Air, A2W : Air to Water

- When DHW Priority is enabled, hot water (heating) operation is given priority only if the A2A & A2W simultaneous operation is on. Other operations are the same as when A2A Priority is enabled.
- How to set DHW Priority:

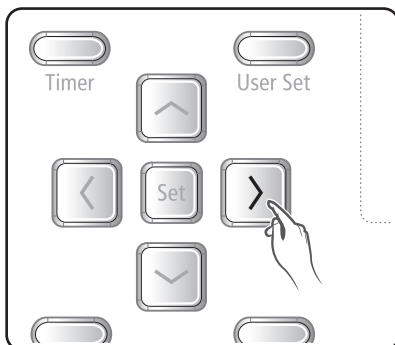

1. Press the ">" key on the wired remote controller for 3 seconds. The setting value is changed in order of DHW Priority (🔌:blink) → A2A Priority (🏠:blink) → DHW Priority (🔌:blink) → A2A Priority (🏠:blink) repeatedly.
2. Setting FSV #5033 to '0' becomes 'A2A Priority', and setting to '1' becomes 'DHW Priority'.

⚠ CAUTION

- While A2W is in operation, A2A does not operate. This is a normal operation.
- While A2A or A2W is not in simultaneous operation, you can use any mode without operation mode restriction.

Cleaning the Air Conditioner

Cleaning the indoor unit exterior

Wipe the surface of the unit with a slightly wet or dry cloth when needed. Wipe off dirt from odd-shaped areas by using a soft brush.

⚠ CAUTION

- Do not use alkaline detergent, sulphuric acid, hydrochloric acid, or organic solvents (such as thinner, kerosene, and acetone) to clean the surfaces.
- Do not put any stickers on it as this can damage the surface of the indoor unit.

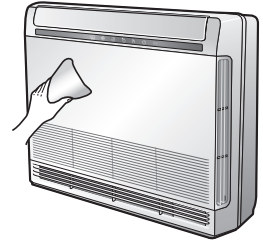

Cleaning the air filter

When cleaning the filter, make sure to unplug the power from the unit. No special tools are needed to clean it.

Air filter

Washable air filter captures large particles from the air. The filter is cleaned with a vacuum or by hand washing. Filter clean indicator will light up when air filter need to be cleaned.

1. Open the front panel.

Grab the top portion of the front panel and pull the front cover towards yourself. Unhook the safety string and lift up the front panel.

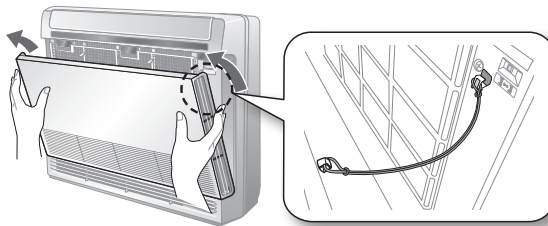

2. Grab the handle and slightly press the air filter down to bent the air filter. Then, pull the Air filter towards you and lift it up to remove the Air filter.

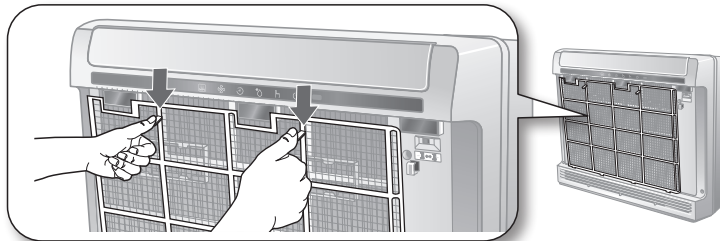

3. Clean the Air filter with a vacuum cleaner or soft brush. If dust is too heavy, then rinse it with running water and dry it in a ventilated area.

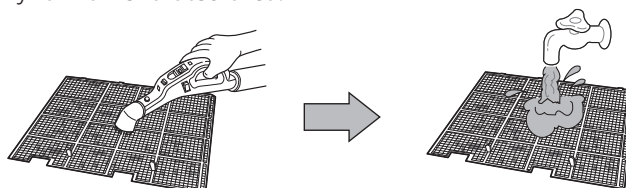

NOTE

- For the best conditions, repeat every two weeks.
- If the Air filter dries in a confined (or humid) area, odors may generate. If it occurs, re-clean and dry it in a well-ventilated area.

4. Insert the Air filter back in its original position.

5. Close the front panel.

Grab the side of the front panel and place the bottom first, then push the panel.

6. Press the Filter Reset button on the remote control.

Anti-allergy filter

Washable Anti-allergy filter leads to reduction in allergens that thrive in polluted air. The filter is cleaned with a vacuum or by hand washing.

1. Open the front panel.

Grab the top portion of the front panel and pull the front cover towards yourself. Unhook the safety string and lift up the front panel.

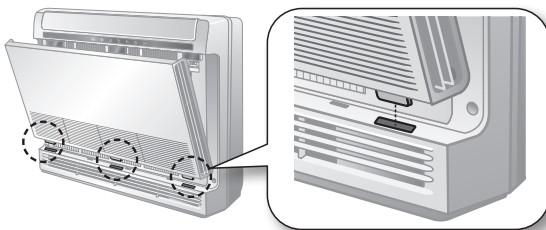

2. Grab the handle and slightly press the air filter down to bent the air filter. Then, pull the Air filter towards you and lift it up to remove the Air filter.

3. Pull and slide out the Anti-allergy filter.

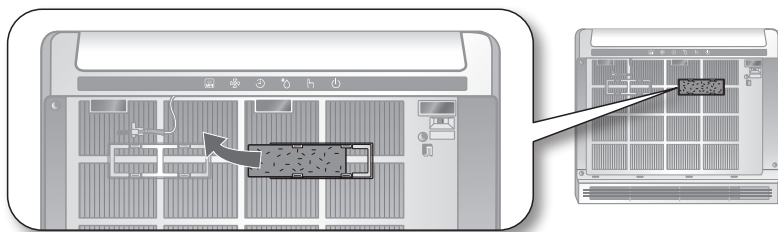

4. Clean the Anti-allergy filter with a vacuum cleaner or soft brush. Then rinse it with running water and dry it in a ventilated area.

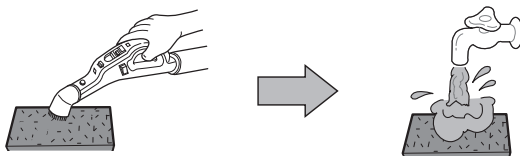

Cleaning the Air Conditioner

5. Install the Anti-allergy filter back in position.
6. Close the front panel.
Grab the side of the front panel and place the bottom first, then push the panel.

NOTE

- Clean the Anti-allergy filter every 3 months. The cleaning term may differ on usage and environmental conditions.

Replacing the air filter

Replacement filter may be purchased from the retail store or ordered from the dealer where you purchased the unit. If you cannot find one, please call a contact center.

Deodorizing filter

Deodorizing filter absorbs efficiently cigarette smoke, pet odors and other unpleasant smells. Deodorizing filter cleaning is simple, just remove old filter and install a new one.

1. Open the front panel.
Grab the top portion of the front panel and pull the front cover towards yourself. Unhook the safety string and lift up the front panel.
2. Grab the handle and slightly press the air filter down to be wnt the air filter. Then, pull the Air filter towards you and lift it up to remove the Air filter.
3. Pull and slide out the Deodorizing filter.

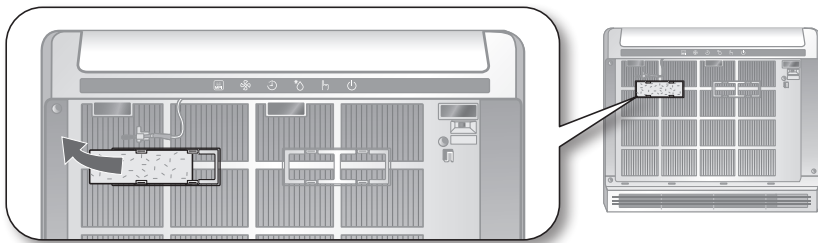
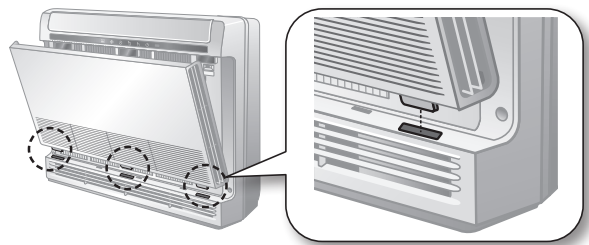

4. Install the new Deodorizing filter back in position.
5. Close the front panel.
Grab the side of the front panel and place the bottom first, then push the panel.

NOTE

- The replacement timing of the Deodorizing filter differs depending on usage and environmental conditions.
- Even if Deodorizing and Anti-allergy filters are installed in an inverted position it will not significantly affect its filtration system.

Maintaining the Air Conditioner

If the air conditioner will not be used for an extended period of time, dry the air conditioner to maintain in best conditions.

1. Dry the air conditioner thoroughly by operating in Fan mode for 3 to 4 hours and disconnect the power plug. There may be internal damage if moisture is left in components.
2. Before using the air conditioner again, dry the inner components of the air conditioner again by running in Fan mode for 3 to 4 hours. This helps remove odours that may have generated from dampness.

Periodical checks

Refer to the following chart to maintain the air conditioner properly.

Type	Description	Monthly	Every 4 months	Once a year
Indoor unit	Clean the air filter (1).	●		
	Clean the condensate drain pan (2).			●
	Thoroughly clean the heat exchanger (2).			●
	Clean the condensate drain pipe (2).		●	
	Replace the remote control batteries (1).			●
Outdoor unit	Clean the heat exchanger on the outside of the unit (2).		●	
	Clean the heat exchanger on the inside of the unit (2).			●
	Clean the electric components with jets of air (2).			●
	Verify that all the electric components are firmly tightened (2).			●
	Clean the fan (2).			●
	Verify that all the fan assembly is firmly tightened (2).			●
	Clean the condensate drain pan (2).			●

NOTE

- The checks and maintenance operations described above are essential to guarantee the efficiency of the air conditioner. The frequency of these operations may vary depending on the characteristics of the area, the amount of dust, etc.
 - a. The above mentioned operations should be performed more frequently if the area of installation is very dusty.
 - b. These operations must always be performed by qualified personnel. For more detailed information, refer to Installation Manual.

Maintaining the Air Conditioner

Internal protections via the unit control system

This internal protection operates if an internal fault occurs in the air conditioner.



Type	Description
Against cold air	The internal fan will be off against cold air when the heat pump is heating.
De-ice cycle	The internal fan will be off against cold air when the heat pump is heating.
Anti-protection of internal battery	The compressor will be off to protect internal battery when the air conditioner operates in Cool mode.
Protect compressor	The air conditioner does not start operating immediately to protect the compressor of the outdoor unit after it has been started.

NOTE



- If the heat pump is operating in Heat mode, the de-ice cycle is actuated to remove frost from an outdoor unit that may have deposited at low temperatures.
- The internal fan is switched off automatically and restarted only after the de-ice cycle is completed.
- When the de-ice cycle is operating, it may generate strange sound. It is normal operation for product safety.

Troubleshooting

Refer to the following chart if the air conditioner operates abnormally. This may save time and unnecessary expense.

Problem	Solution
<p>The air conditioner does not operate at all.</p>	<ul style="list-style-type: none"> • Check if the power plug is properly connected. • Check whether the auxiliary power switch (MCCB, ELB) is turned on. • If the auxiliary power switch (MCCB, ELB) is turned off, the air conditioner does not work although you press the  (Power) button. • When you clean the air conditioner or do not use it for an extended period of time, turn off the auxiliary power switch (MCCB, ELB). • After the air conditioner is not used for an extended period of time, be sure to turn on the auxiliary power switch (MCCB, ELB) 6 hours before starting operation. <p> NOTE</p> <ul style="list-style-type: none"> • The auxiliary power switch (MCCB, ELB) is sold separately. • Make sure that auxiliary power switch (MCCB, ELB) is installed in the distribution box inside the building. <ul style="list-style-type: none"> • If the air conditioner is turned off by the Timed off function, turn on the air conditioner again by pressing the  (Power) button. • While A2W is in operation, A2A does not operate. This is a normal operation.
<p>The temperature does not change.</p>	<ul style="list-style-type: none"> • Check whether the Fan mode is running. In the Fan mode, the air conditioner controls the set temperature automatically, and you cannot change the set temperature.
<p>Warm air does not come out of the air conditioner.</p>	<ul style="list-style-type: none"> • Check whether the outdoor unit is designed for cooling only. In this case, warm air does not come out although you select the Heat mode. • Check whether the remote control is designed only for cooling only. Use a remote control that supports both cooling and heating.
<p>The fan speed does not change.</p>	<ul style="list-style-type: none"> • Check whether the Auto or Dry mode is running. In these modes, the air conditioner controls the fan speed automatically, and you cannot change the fan speed.
<p>The wireless remote control does not operate.</p>	<ul style="list-style-type: none"> • Check whether the batteries are discharged. Replace the batteries with new ones. • Make sure that nothing is blocking the remote control sensor. • Check whether any strong lighting sources are near the air conditioner. Strong light which comes from fluorescent bulbs or neon signs may interfere with the remote control.

Troubleshooting

Problem	Solution
The wired remote control does not operate.	<ul style="list-style-type: none"> Check whether the  indicator is displayed at the bottom right of the remote control display. In this case, turn off both the air conditioner and the auxiliary power switch, and then contact a service centre.
The air conditioner is not turned on or off immediately with the wired remote control.	<ul style="list-style-type: none"> Check whether the wired remote control is set for group control. In this case, the air conditioners connected to the wired remote control are turned on or off sequentially. This operation takes up to 32 seconds.
The Timed on/off function does not operate.	<ul style="list-style-type: none"> Check whether you pressed the  (SET) button on the remote control after setting the on/off time. Set the on/off time.
The indoor unit display blinks continuously.	<ul style="list-style-type: none"> Turn on the air conditioner again by pressing the  (Power) button. Turn off and then turn on the auxiliary power switch, and then turn on the conditioner. If the indoor unit display is still blinking, contact a service centre.
I want to get cooler air.	<ul style="list-style-type: none"> Operate the air conditioner with a electric fan to save energy and enhance the cooling efficiency.
The air is not cool or warm enough.	<ul style="list-style-type: none"> In the Cool mode, cool air does not come out if the set temperature is higher than the current temperature. <ul style="list-style-type: none"> MR-EH00 remote control: Press the Temperature button repeatedly until the set temperature (minimum: 18°C) is set to lower than the current temperature. AR-KH00E remote control: Press the Temperature button on the remote control. Then rotate the Wheel until the set temperature (minimum: 18°C) is set to lower than the current temperature. In the Heat mode, warm air does not come out if the set temperature is lower than the current temperature. <ul style="list-style-type: none"> MR-EH00 remote control: Press the Temperature button repeatedly until the set temperature (maximum: 30°C) is set to higher than the current temperature. AR-KH00E remote control: Press the Temperature button on the remote control. Then rotate the Wheel until the set temperature (maximum: 30°C) is set to higher than the current temperature.

Problem	Solution
<p>The air is not cool or warm enough.</p>	<ul style="list-style-type: none"> • Both cooling and heating do not operate in the Fan mode. Select the Cool, Heat, Auto, or Dry mode. • Check whether the air filter is blocked with dirt. A dusty filter may decrease the cooling and heating efficiencies. Clean the air filter frequently. • If a cover is on the outdoor unit or any obstacle is present near the outdoor unit, remove them. • Install the outdoor unit in a well-ventilated place. Avoiding places exposed to direct sunlight or close to a heating appliance. • Place a sunscreen over the outdoor unit to protect it from direct sunlight. • If the indoor unit is installed in a place exposed to direct sunlight, pull the curtains on the windows. • Close the windows and doors to maximize the cooling and heating efficiencies. • If the Cool mode is stopped and then started immediately, cool air comes out after about 3 minutes to protect the compressor of the outdoor unit. • When the Heat mode is started, warm air does not come out immediately to prevent cool air from coming out at the beginning. • If the refrigerant pipe is too long, the cooling and heating efficiencies may be decreased. Avoid exceeding the maximum pipe length.
<p>The air conditioner makes strange noises.</p>	<ul style="list-style-type: none"> • In certain conditions (especially, when the outdoor temperature is lower than 20°C), a hissing, rumbling, or splashing sound may be heard while the refrigerant is circulating through the air conditioner. This is a normal operation. • When you press the  (Power) button on the remote control, noise may be heard from the drain pump inside the air conditioner. This noise is a normal sound.
<p>Unpleasant odours permeate the room.</p>	<ul style="list-style-type: none"> • If the air conditioner is running in a smoky area or if there is a smell entering from outside, ventilate the room properly. • If both indoor temperature and indoor humidity are high, operate the air conditioner in the Clean or Fan mode for 1 to 2 hours. • If the air conditioner has not been operated for an extended period of time, clean the indoor unit and then operate the air conditioner in the Fan mode for 3 to 4 hours to dry the inside of the indoor unit for removal of unpleasant odours. • If the air filter blocked with dirt, clean the air filter.

Troubleshooting

Problem	Solution
Steam is produced on the indoor unit.	<ul style="list-style-type: none">• In winter, if the indoor humidity is high, steam may be produced around the air outlet while the defrost function is running. This is a normal operation.
The outdoor unit fan continues to operate when the air conditioner is turned off.	<ul style="list-style-type: none">• When the air conditioner is turned off, the outdoor unit fan may continue to operate to reduce noise of the refrigerant gas. This is a normal operation.
Water drops from the piping connections of the outdoor unit.	<ul style="list-style-type: none">• Condensation may develop due to the difference in temperature. This is a normal condition.
Steam is produced on the outdoor unit.	<ul style="list-style-type: none">• In winter, when the air conditioner runs in the Heat mode, the frost on the heat exchanger melts and steam may be produced. This is a normal operation, neither product malfunction nor a fire.

Operation Features

Operating temperature and humidity

Mode	Outdoor temperature	Indoor temperature	Indoor humidity
Cool mode	-5°C to 48°C	18°C to 32°C	80% or less
Heat mode	-20°C to 28°C	27°C or less	-
Dry mode	-5°C to 48°C	18°C to 32°C	-

 **NOTE**

- The standardized temperature for heating is 7°C. If the outdoor temperature drops to 0°C or below, the heating capacity can be reduced depending on the temperature condition.
- If the cooling operation is used at over 32°C (indoor temperature), it does not cool at its full capacity.

Technical specifications

Type	Model	Net weight (kg)	Net dimension (W x D x H) (mm)
Indoor unit	AE022MNJDEH/EU	15.5	720 x 620 x 199
	AE028MNJDEH/EU	16.0	720 x 620 x 199
	AE036MNJDEH/EU	16.0	720 x 620 x 199
	AE056MNJDEH/EU	16.0	720 x 620 x 199