



Contents

Safety Information	4
Safety Information	4
At a Glance	12
Indoor Unit Overview	12
Display	
Remote Control Overview	13
Replacing batteries	
Storing the remote control	
Basic Operation	15
Operation Modes	15
Auto	
Cool	
Dry	
Fan	
Heat	
Turning the air conditioner on	
Selecting the operation mode	
Adjusting the temperature	
Selecting the fan speed	
Selecting air flow direction	
Advanced Operation	19
Setting the On or Off timer	19
Setting the On timer	
Setting the Off timer	
Using the good'sleep Function	21
Using the Turbo Function	23
Controlling Indoor Units	24
Cleaning and Maintenance	25
Cleaning the Air Conditioner	25
Cleaning the exterior	
Disassembling the air filter	





Cleaning the Air Conditioner	26
Cleaning the air filter	
Reassembling the air filter	
Maintaining the Air Conditioner	27
Appendix	29
Troubleshooting	29
Operation Ranges	31
Model specification (Dimension and weight)	
Installation part	33
Installation Procedure	33



***Correct Disposal of This Product
(Waste Electrical & Electronic Equipment)***

(Applicable in countries with separate collection systems)

This marking on the product, accessories or literature indicates that the product and its electronic accessories (e.g. charger, headset, USB cable) should not be disposed of with other household waste at the end of their working life. To prevent possible harm to the environment or human health from uncontrolled waste disposal, please separate these items from other types of waste and recycle them responsibly to promote the sustainable reuse of material resources.

Household users should contact either the retailer where they purchased this product, or their local government office, for details of where and how they can take these items for environmentally safe recycling.

Business users should contact their supplier and check the terms and conditions of the purchase contract. This product and its electronic accessories should not be mixed with other commercial wastes for disposal.

For information on Samsung's environmental commitments and product specific regulatory obligations e.g. REACH visit: samsung.com/uk/aboutsamsung/samsungelectronics/corporatecitizenship/data_corner.html





Safety Information





Before using your new air conditioner, please read this manual thoroughly to ensure that you know how to safely and efficiently operate the extensive features and functions of your new appliance. Because the following operating instructions cover various models, the characteristics of your air conditioner may differ slightly from those described in this manual. If you have any questions, call your nearest contact centre or find help and information online at www.samsung.com.

WARNING

Hazards or unsafe practices that may result in severe personal injury or death.

CAUTION

Hazards or unsafe practices that may result in minor personal injury or property damage.

-  Follow directions.
-  Do NOT attempt.
-  Make sure the machine is grounded to prevent electric shock.
-  Cut off the power supply.
-  Do NOT disassemble.

FOR INSTALLATION

WARNING

-  **Use the power line with the power specifications of the product or higher and use the power line for this appliance only. In addition, do not use an extension line.**
 - Extending the power line may result in electric shock or fire.
 - Do not use an electric transformer. This may result in electric shock or fire.





- If the voltage/frequency/rated current condition is different, it may cause fire.

The installation of this appliance must be performed by a qualified technician or service company.

- Failing to do so may result in electric shock, fire, explosion, problems with the product, or injury and may also void warranty on the installed product.

Install an Isolation Switch next to the Air Conditioner (but not on the panels of the Air Conditioner) and circuit breaker dedicated to the air conditioner.

- Failing to do so may result in electric shock or fire.

Fix the outdoor unit firmly so that the electric part of the outdoor unit is not exposed.

- Failing to do so may result in electric shock, fire, explosion, or problems with the product.

⊘ Do not install this appliance near a heater, or inflammable material. Do not install this appliance in a humid, oily or dusty location, in a location exposed to direct sunlight and water (rain drops). Do not install this appliance in a location where gas may leak.

- This may result in electric shock or fire.

Never install the outdoor unit in a location such as on a high external wall where it could fall.

- If the outdoor unit falls, it may result in injury, death or property damage.

⚡ This appliance must be properly grounded. Do not ground the appliance to a gas pipe, plastic water pipe, or telephone line.

- Failure to do so may result in electric shock, fire, an explosion, or other problems with the product.
- Make sure to use a socket-outlet with ground.





Safety Information

CAUTION

-  Please cover the air conditioner with PE BAG after installation, and remove it when you start to run air conditioner.

Install your appliance on a level and hard floor that can support its weight.

- Failing to do so may result in abnormal vibrations, noise, or problems with the product.

Install the drain hose properly so that water drains correctly.



- Failing to do so may result in water overflowing and property damage. Avoid adding drain to waste pipes as odours may arise in the future.

When installing the outdoor unit, make sure to connect the drain hose so that draining is performed correctly.

- The water generated during the heating operation in the outdoor unit may overflow and result in property damage. In particular, in winter, if a block of ice falls, it may result in injury, death or property damage.

FOR POWER SUPPLY

WARNING

-  When the circuit breaker is damaged, contact your nearest service centre.
-  Do not pull or excessively bend the power line. Do not twist or tie the power line. Do not hook the power line over a metal object, place a heavy object on the power line, insert the power line between objects, or push the power line into the space behind the appliance.
 - This may result in electric shock or fire.



**CAUTION**

When not using the air conditioner for a long period of time or during a thunder/lightning storm, cut the power at the circuit breaker.

- Failing to do so may result in electric shock or fire.

FOR USING**WARNING**

If the appliance is flooded, please contact your nearest service centre.

- Failing to do so may result in electric shock or fire.

If the appliance generates a strange noise, a burning smell or smoke, cut off the power supply immediately and contact the nearest service centre.

- Failing to do so may result in electric shock or fire.

In the event of a gas leak (such as propane gas, LP gas, etc.), ventilate immediately without touching the power line. Do not touch the appliance or power line.

- Do not use a ventilating fan.
- A spark may result in an explosion or fire.

To reinstall the air conditioner, please contact your nearest service centre.

- Failing to do so may result in problems with the product, water leakage, electric shock, or fire.
- Delivery service for the product is not provided. If you reinstall the product in another location, additional construction expenses and an installation fee will be charged.





Safety Information

- Especially, when you wish to install the product in an unusual location such as in an industrial area or near the seaside where it is exposed to salt in the air, please contact your nearest service centre.

⊘ Do not touch the circuit breaker with wet hands.

- This may result in electric shock.

Do not turn the air conditioner off with the circuit breaker while it is operating.

- Turning the air conditioner off and then on again with the circuit breaker may cause a spark and result in electric shock or fire.

After unpacking the air conditioner, keep all packaging materials well out of the reach of children, as packaging materials can be dangerous to children.

- If a child places a bag over its head, it may result in suffocation.

Do not touch the front panel with your hands or fingers during the heating operation.

- This may result in electric shock or burns.

Do not insert your fingers or foreign substances into the air inlet/outlet of the air conditioner.

- Take special care that children do not injure themselves by inserting their fingers into the product.

Do not strike or pull the air conditioner with excessive force.

- This may result in fire, injury, or problems with the product.

Do not place an object near the outdoor unit that allows children to climb onto the machine.

- This may result in children seriously injuring themselves.



Do not use this air conditioner for long periods of time in badly ventilated locations or near infirm people.

- Since this may be dangerous due to a lack of oxygen, open a window at least once an hour.

 **If any foreign substance such as water has entered the appliance, cut the power by unplugging the power plug and turning the circuit breaker off and then contact your nearest service centre.**

- Failing to do so may result in electric shock or fire.

 **Do not attempt to repair, disassemble, or modify the appliance yourself.**

- Do not use any fuse (such as copper, steel wire, etc.) other than the standard fuse.
- Failing to do so may result in electric shock, fire, problems with the product, or injury.

 **CAUTION**

 **Do not place objects or devices under the indoor unit.**

- Water dripping from the indoor unit may result in fire or property damage.

Check that the installation frame of the outdoor unit is not broken at least once a year.

- Failing to do so may result in injury, death or property damage.

Max current is measured according to IEC standard for safety and current is measured according to ISO standard for energy efficiency.

 **Do not stand on top of the appliance or place objects (such as laundry, lighted candles, lighted cigarettes, dishes, chemicals, metal objects, etc.) on the appliance.**





Safety Information

- This may result in electric shock, fire, problems with the product, or injury.

Do not operate the appliance with wet hands.

- This may result in electric shock.

Do not spray volatile material such as insecticide onto the surface of the appliance.

- As well as being harmful to humans, it may also result in electric shock, fire or problems with the product.

Do not drink the water from the air conditioner.

- The water may be harmful to humans.

Do not apply a strong impact to the remote control and do not disassemble the remote control.

Do not touch the pipes connected with the product.

- This may result in burns or injury.

Do not use this air conditioner to preserve precision equipment, food, animals, plants or cosmetics, or for any other unusual purposes.

- This may result in property damage.

Avoid directly exposing humans, animals or plants to the air flow from the air conditioner for long periods of time.

- This may result in harm to humans, animals or plants.

This appliance is not intended for use by persons (including children) with reduced physical, sensory or mental capabilities, or lack of experience and knowledge, without supervision or instruction concerning use of the appliance by a person responsible for their safety. Children should be supervised to ensure that they do not play with the appliance.





For use in Europe : This appliance can be used by children aged from 8 years and above and persons with reduced physical, sensory or mental capabilities or lack of experience and knowledge if they have been given supervision or instruction concerning use of the appliance in a safe way and understand the hazards involved. Children shall not play with the appliance. Cleaning and user maintenance shall not be made by children without supervision.

FOR CLEANING

WARNING

 **Do not clean the appliance by spraying water directly onto it. Do not use benzene, thinner, alcohol or acetone to clean the appliance.**

- This may result in discolouration, deformation, damage, electric shock or fire.

Before cleaning or performing maintenance, cut off the power supply and wait until the fan stops.

- Failing to do so may result in electric shock or fire.

CAUTION

 **Take care when cleaning the surface of the heat exchanger of the outdoor unit since it has sharp edges.**

- This should be done by a qualified technician. Please contact your installer or service centre.

 **Do not clean the inside of the air conditioner by yourself.**

- For cleaning inside the appliance, contact your nearest service centre.
- When cleaning the filter, refer to the descriptions in the 'Cleaning at a Glance' section.
- Failing to do so may result in damage, electric shock or fire.





Indoor Unit Overview

The actual product may differ slightly from the image depicted below.

At a Glance

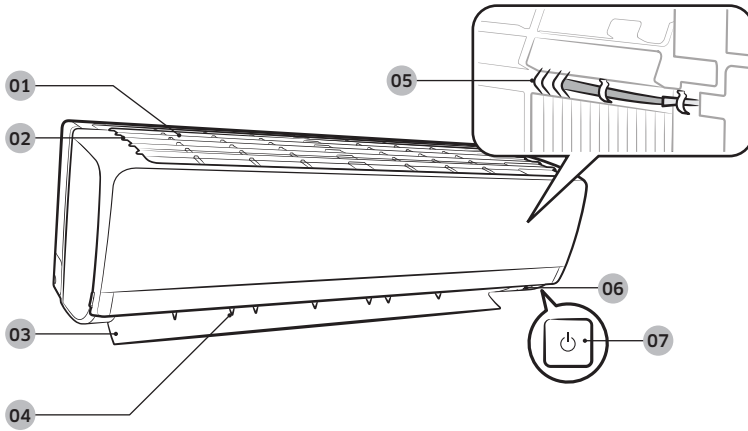

- 01 Air intake
- 02 Air filter (under the panel)
- 03 Air flow blade (up and down)
- 04 Air flow blade (left and right)
- 05 Room temperature sensor
- 06 Display
- 07 Power button / Remote control receiver

Display

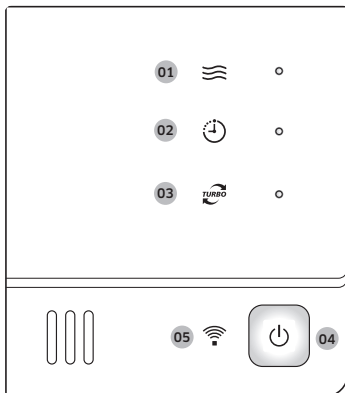

- 01 Operation indicator
- 02 Timer indicator
- 03 Turbo indicator
- 04 Power button
- 05 Remote controller receiver



Remote Control Overview

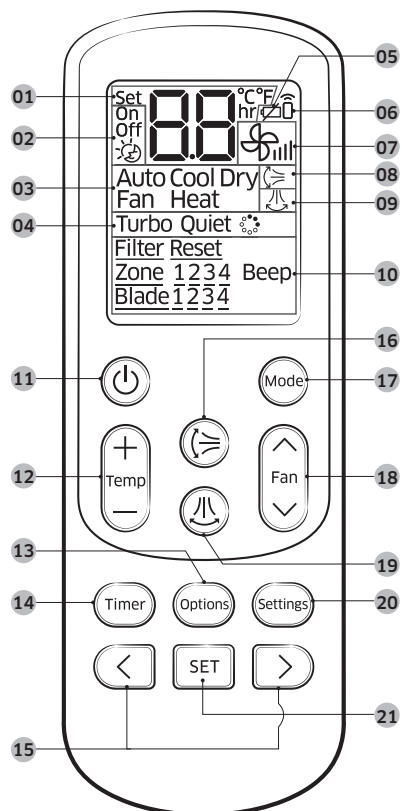

- 01 Set temperature indicator
- 02 Timer option indicator
- 03 Operation mode indicator
- 04 Options indicator
- 05 Low battery indicator
- 06 Transmit indicator

- 07 Fan speed indicator
- 08 Vertical air swing indicator
- 09 Horizontal air swing indicator

NOTE

- This function is not available in this model.

- 10 Settings indicator
- 11 Power button
- 12 Temperature button
- 13 Options button
- 14 Timer button
- 15 Direction button/Selection button
- 16 Vertical air swing button
- 17 Mode button
- 18 Fan speed button
- 19 Horizontal air swing button

NOTE

- This function is not available in this model.

- 20 Settings button
- 21 SET button

NOTE

- The air conditioner may not be operated by the remote control if the controller is placed close to strong light such as a fluorescent lamp or neon sign. In this case, use the remote control right in front of the remote control receiver of the indoor unit.
- If other electrical products are operated by the remote control, call your nearest service center.
- To silence the beep sound, press the **Settings** → <, > or **Settings** → (Beep) blinking → **SET** button. When you press the **Settings** → <, > or **Settings** → (Beep) blinking → **SET** button again, the beep sound will be active again.



Remote Control Overview

Replacing batteries

When the  icon appears in the remote control display, replace the batteries with new ones. Two 1.5V AAA type batteries are required.

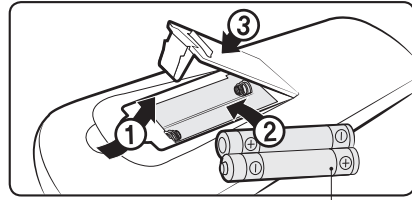

two 1.5V AAA type batteries

At a Glance



Correct disposal of batteries in this product

(Applicable in countries with separate collection systems)

This marking on the battery, manual or packaging indicates that the batteries in this product should not be disposed of with other household waste at the end of their working life. Where marked, the chemical symbols Hg, Cd or Pb indicate that the battery contains mercury, cadmium or lead above the reference levels in EC Directive 2006/66. If batteries are not properly disposed of, these substances can cause harm to human health or the environment.

To protect natural resources and to promote material reuse, please separate batteries from other types of waste and recycle them through your local, free battery return system.

Storing the remote control

If the remote control will not be used for an extended period of time, store it in the remote control holder with the batteries removed.

CAUTION

- Make sure that water does not come into the remote control.

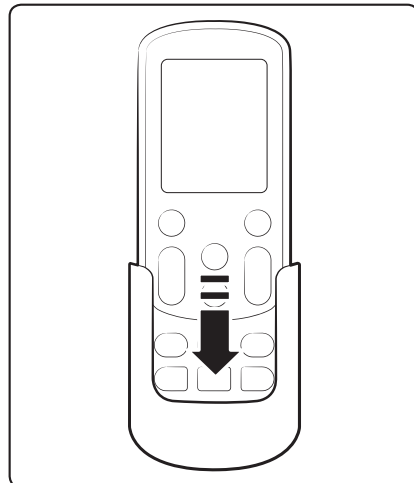

Operation Modes



Auto

In Auto mode, the air conditioner will automatically adjust the temperature and fan speed to maintain your fresh environment.

- When the indoor temperature is too high, the powerful cool breeze is generated and when the indoor room becomes cool enough, the soft breeze is generated.

Cool

The Cool mode is frequently used and you can freely control the temperature, fan speed, and air flow direction in Cool mode.

- When you select the Heat mode while the Cool mode is on, the Cool mode is cancelled.

Dry

The air conditioner in Dry mode acts like a dehumidifier by removing moisture from the indoor air. The Dry mode will provide you with fresh air even on a rainy day.

Fan

The Fan mode provides you with a breeze just like a fan to make fresh environment for you.

Operation Modes



Heat

In Heat mode, you can warm your room even in fall and winter.

- The fan may not commence immediately to avoid generating a cold breeze.
- In Heat mode, defrost operation may be performed to remove the frost formed on the outdoor unit. (When the frost is removed by the defrost operation in Heat mode, steam is generated from the outdoor unit.)
- If you stop operating the air conditioner after heating operation, the fan will operate for some time to cool the indoor unit.
- When you select the Cool mode while the Heat mode is on, the Heat mode is cancelled.

NOTE

- When the outdoor temperature is relatively low and the humidity is relatively high in Heat mode, the outdoor unit's heating capacity may decrease due to the frost formed on the outdoor heat exchanger. The defrost operation removes the frost formed on the heat exchanger of the outdoor unit for 5 to 12 minutes. During the defrost operation, the indoor unit does not generate breeze in order to prevent cold breeze blowing out.
 - The interval between defrost operations can decrease depending on the amount of the frost formed on the outdoor unit.
 - The interval between defrost operations can also decrease depending on the humidity level in the air.

Basic Operation



Turning the air conditioner on

Press the button to operate the air conditioner.

Selecting the operation mode

Press the button to select an operation mode.

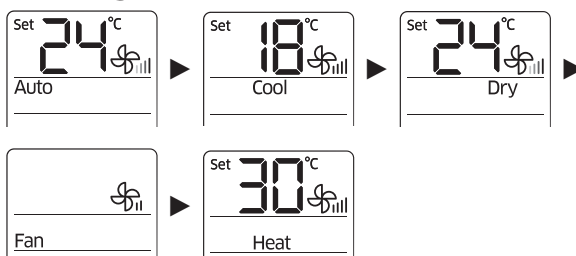

Adjusting the temperature

Press the button to adjust the temperature.

Mode	Temperature control
Auto/Cool/Dry	Adjust by 1 °C between 18 °C and 30 °C.
Heat	Adjust by 1 °C between 16 °C and 30 °C.
Fan	Temperature cannot be adjusted.

Selecting the fan speed

Press the button to adjust the fan speed.

Mode	Available fan speeds
Auto/Dry	(Auto)
Cool/Heat	(Auto), (Low), (Med), (High)
Fan	(Low), (Med), (High)



Basic Operation

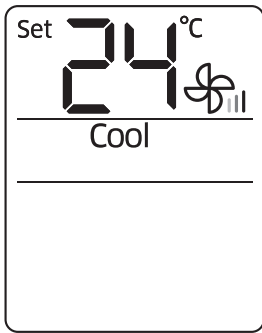
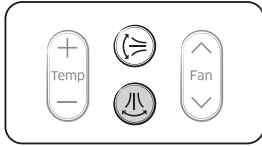

Remote control display

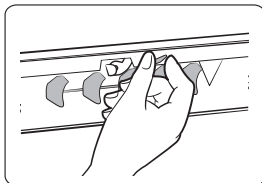

Selecting air flow direction

Keep the air flow in a constant direction by stopping the movements of the vertical and horizontal air flow blades.

In operation ▶

NOTE

- If you adjust the vertical air flow blade manually, it may not close completely when you turn off the air conditioner.

Horizontal air flow (manual)

Keep the horizontal air flow in a constant direction by changing the directions of the horizontal air flow blades manually.

NOTE

- Although you press the button, this function does not work.

CAUTION

- To prevent personal injury, make sure that you change the directions of the horizontal air flow blades after stopping the movements of the vertical air flow blade.

Setting the On or Off timer

You can set the air conditioner to be turned on or off automatically at the desired time.

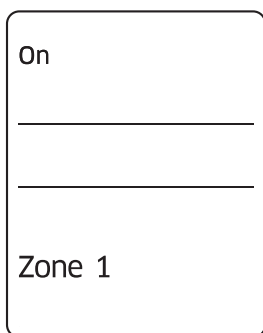
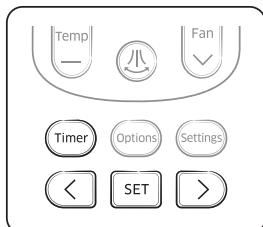

Remote control display

Setting the On timer

When the air conditioner is turned off:

1. Press the **Timer** button to select (On).
 - The (On) indicator will keep blinking and you can set the time.
2. Press the **<** or **>** button to set the time.
 - You can set the time in half hour intervals from 30 minutes (0.5 on the display) to 3 in hour intervals from 3 to 24 hours.
 - The time can be set from minimum 30 minutes to maximum 24 hours.
3. Press the **SET** button to complete the On timer setting.
 - The (On) indicator and the set time of the timer will be displayed on the remote control display.
 - On timer setting will be cancelled if you don't press the **SET** button within 10 seconds after setting the time. Therefore, check for the (On) indicator on the remote control display.

Cancel	Press the Timer button ► select (On) ► press the < or > button ► set the timer to 00 ► press the SET button
---------------	--

Additional options available in the On timer	
	Select the mode in the following order: (Auto) ► (Cool) ► (Dry) ► (Fan) and ► (Heat).
	You can adjust the temperature after timer setting is completed. Temperature adjustment is only available in Auto, Cool, Dry, and Heat modes. In Fan mode, the temperature cannot be adjusted.

NOTE

- When On timer setting is completed, the setting will be displayed for 3 seconds, and then only the (On) indicator will remain on the remote control display.
- You cannot set the Fan speed when setting the On timer.

Advanced Operation

Setting the On or Off timer

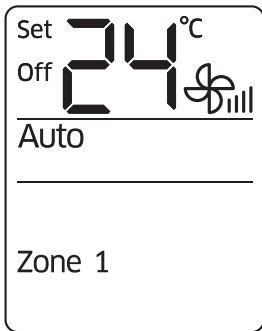
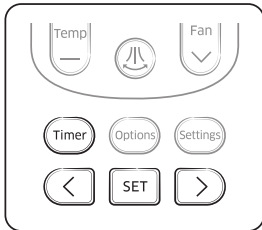

Remote control display

Setting the Off timer

When the air conditioner is turned on:

1. Press the **Timer** button to select (Off).
 - The (Off) indicator will keep blinking and you can set the time.
2. Press the **<** or **>** button to set the time.
 - You can set the time in half hour intervals from 30 minutes (0.5 on the display) to 3 hours and in hour intervals from 3 to 24 hours.
 - The time can be set from minimum 30 minutes to maximum 24 hours.
3. Press the **SET** button to complete the Off timer setting.
 - The (Off) indicator and the set time of the timer will be displayed on the remote control display.
 - Off timer setting will be cancelled if you don't press the **SET** button within 10 seconds after setting the time. Therefore, check for the (Off) indicator on the remote control display.

Cancel	Press the Timer button ► select (Off) ► press the < or > button ► set the timer to 00 ► press the SET button
---------------	---

NOTE

- Only the latest timer setting will be applied between the Off timer and good' sleep off timer functions.

Combining On timer and Off timer

When the air conditioner is turned off	When the air conditioner is turned on
When the set time on On timer is less than that on Off timer e.g. On timer: 3 hours, Off timer: 5 hours <ul style="list-style-type: none"> • The air conditioner will be turned on after 3 hours from the moment you have set the timer and the air conditioner will remain on for 2 hours and then be turned off automatically. 	When the set time on On timer is greater than that on Off timer e.g. On timer: 3 hours, Off timer: 1 hour <ul style="list-style-type: none"> • The air conditioner will be turned off after 1 hour from the moment you have set the timer and will be automatically turned on after 2 hours from the moment it was turned off.

NOTE

- The set times for the On timer and the Off timer should be different from each other.
- After the On timer or the Off timer is set, the setting can be cancelled by pressing the **Power** button.



Using the good'sleep Function

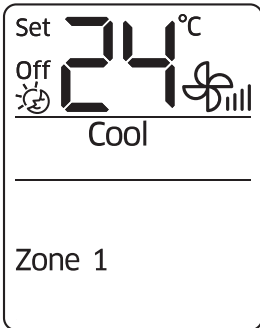
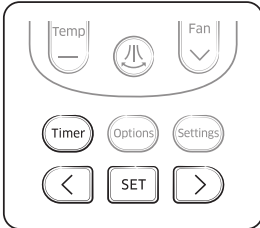

Remote control display

When the air conditioner is operating in **Cool** mode;

1. Press the **Timer** button to select .
 - The indicator will keep blinking and you can set the time.
2. Press the **<** or **>** button to set the time.
 - You can set the time in half hour intervals from 30 minutes (0.5 on the display) to 3 hours and in hour intervals from 3 to 12 hours.
 - The time can be set from minimum 30 minutes to maximum 12 hours.
 - The default time value for the good'sleep mode is 8 hours.
3. Press the **SET** button to complete the good'sleep mode setting.
 - The indicator and the set time of the good'sleep mode will be displayed on the remote control display.
 - The good'sleep mode will be cancelled if you don't press the **SET** button within 10 seconds after setting the time. Therefore, check for the indicator on the remote control display.

Cancel	Press the Timer button ► select ► press the < or > button ► set the timer to 00 ► press the SET button
---------------	--

Additional options available in good'sleep mode	
	The temperature can be adjusted by 1 °C (1 °F) within the range of 18 °C (65 °F) to 30 °C (86 °F).

Advanced Operation









Using the good'sleep Function

For a comfortable sleep, the air conditioner will operate in order of 'Fall asleep ► Sound sleep ► Wake up' stages.

- Fall asleep mode: Provides you with comfortable environment for a good sleep by rapid cooling and hypnagogue expedition breeze.
- Sound sleep mode: The sound sleep mode adjusts temperature and air flow in waves to maintain healthy skin temperature while it aids deep sleep. According to the change of good'sleep operation hours, the sound sleep hour can increase or decrease.
- Wake up from good'sleep mode: Provides you with the air flow that adjusts your body temperature to wake you up in a fresh status.

NOTE

- In good'sleep mode, the air conditioner will operate in Cool + () mode for first 30 minutes. The fan speed and air flow direction will be adjusted automatically in good'sleep mode.
- Recommended set temperature is between 25 °C (77 °F) and 27 °C (81 °F) and the value 26 °C (79 °F) is the most ideal temperature.
- If the set temperature is too low, you may feel cold while sleeping or catch a cold.
- Optimal operation time in good'sleep mode is 8 hours. Therefore, if the time is set too short or long, you may not feel as comfortable as you want.
- If the good'sleep mode is set over 5 hours, The Wake up stage will begin when 1 hour is remaining in the operation time and the air conditioner will stop automatically.
- When the On timer and the good'sleep mode are set simultaneously, the air conditioner will only apply the function that was set later.
- While the good'sleep mode is operating, the  mode can be set additionally by pressing the  button.
- If you press the  button and select the Turbo/Quiet function, the good'sleep mode will be cancelled and the selected mode will begin operation.
- If you press the  button, the good'sleep mode will be cancelled and the selected mode will begin operation.





Using the Turbo Function

You can set the Turbo function to provide fast and powerful cooling.

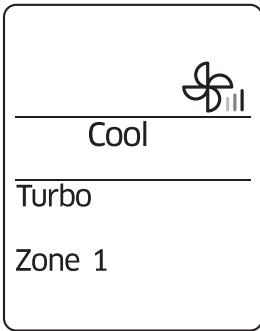
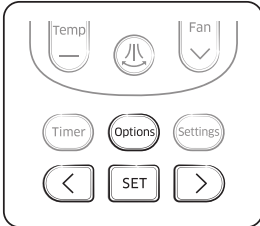

Remote control display

When the air conditioner is operating in Cool mode;

1. Press the **Options** button.
2. Press the **<**, **>** or **Options** button until the (Turbo) indicator starts blinking.
3. Press the **SET** button to set the Turbo function.
 - The (Turbo) indicator will be displayed on the remote control display and Turbo function will operate for 30 minutes.

Cancel	Press the Options button ► press the < , > or Options to make the (Turbo) indicator blink and press the SET button.
---------------	--

NOTE

- Turbo function is available in Cool or Heat mode.
- If the Turbo function is selected while the Quiet function is on, the Quiet function will be cancelled.
- The temperature and fan speed cannot be adjusted.



Controlling Indoor Units

You can individually select and operate indoor units among 4 indoor units.

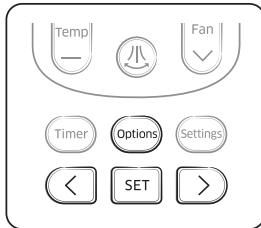

When the air conditioner is turned on:

1. Press the **Settings** button.
2. Press the **<**, **>** or **Settings** button until the (Zone) indicator starts blinking.
3. Press the **SET** button to select the indoor unit to operate.
 - You can select individual units in order of 1 to 4 or select all indoor units at one time.

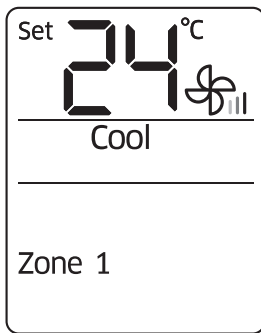

Remote control display





Cleaning the Air Conditioner

Cleaning the exterior

Wipe the surface of the unit with a slightly wet or dry cloth when needed.

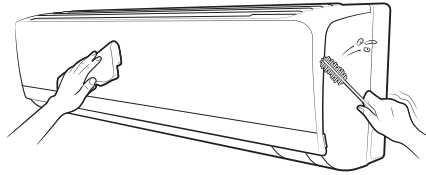

NOTE

- Do not use sulphuric acid, hydrochloric acid, or organic solvents (such as thinner, kerosene, and acetone) to clean the surfaces.
- Do not put any stickers on it as this can damage the surface of the air conditioner.

Disassembling the air filter

1. Remove the front panel.
Tightly grab both sides of the front panel and lift up the panel to open. Then slide the panel towards you for removal.
2. Grab the handle and lift it up. Then, pull the air filter towards you.

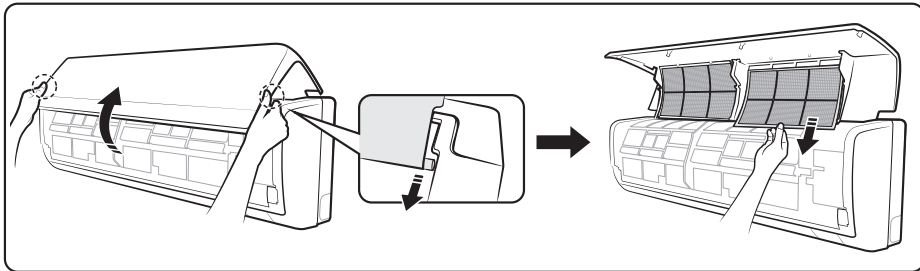



Cleaning the Air Conditioner

Cleaning the air filter

Clean the air filter with a vacuum cleaner or soft brush. If dust is too heavy, then rinse it with running water and dry it in a ventilated area.

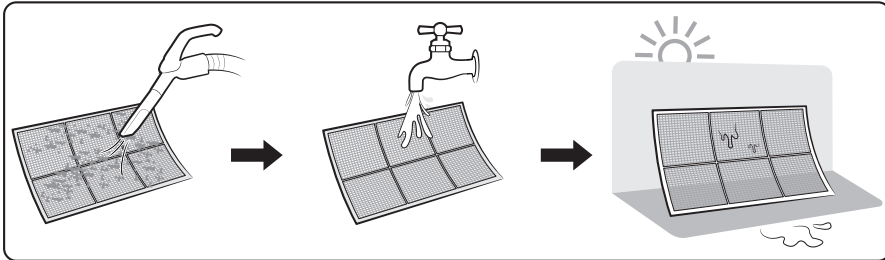

NOTE

- Clean the air filter once every two weeks.
- Spray water or use a vacuum cleaner to remove dust.
- After removing dust, dry the air filter completely.
 - Avoid direct sunlight. Failure to do so may deform the air filter.
- If the air filter is dried in a confined (or humid) area, odours may generate. If it occurs, re-clean and dry it in a well-ventilated area.

Reassembling the air filter

1. Insert the air filter back in its original position.
2. Close the front panel.

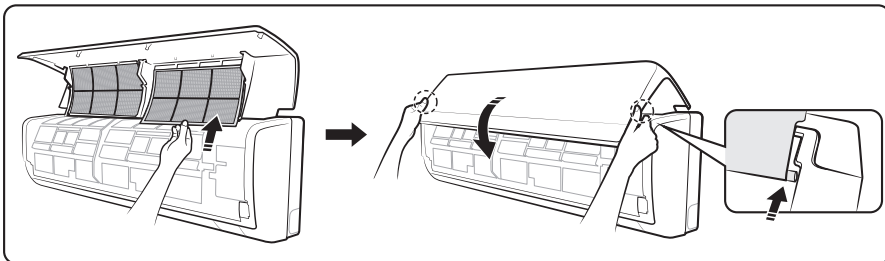



Maintaining the Air Conditioner

If the air conditioner will not be used for an extended period of time, dry the air conditioner to maintain in best conditions.

1. Dry the air conditioner thoroughly by operating in Fan mode for 3 to 4 hours and disconnect the power plug. There may be internal damage if moisture is left in components.
2. Before using the air conditioner again, dry the inner components of the air conditioner again by running in Fan mode for 3 to 4 hours. This helps remove odours that may have generated from dampness.

Periodical checks

Refer to the following chart to maintain the air conditioner properly.

Type	Description	Monthly	Every 4 months	Once a year
Indoor unit	Clean the air filter (1).	●		
	Clean the condensate drain pan (2).			●
	Thoroughly clean the heat exchanger (2).			●
	Clean the condensate drain pipe (2).		●	
	Replace the remote control batteries (1).			●
Outdoor unit	Clean the heat exchanger on the outside of the unit (2).		●	
	Clean the heat exchanger on the inside of the unit (2).			●
	Clean the electric components with jets of air (2).			●
	Verify that all the electric components are firmly tightened (2).			●
	Clean the fan (2).			●
	Verify that all the fan assembly is firmly tightened (2).			●
	Clean the condensate drain pan (2).			●

NOTE

- The checks and maintenance operations described above are essential to guarantee the efficiency of the air conditioner. The frequency of these operations may vary depending on the characteristics of the area, the amount of dust, etc.
 - a. The above mentioned operations should be performed more frequently if the area of installation is very dusty.
 - b. These operations must always be performed by qualified personnel. For more detailed information, refer to Installation Manual.





Maintaining the Air Conditioner

Internal protections via the unit control system

This internal protection operates if an internal fault occurs in the air conditioner.

Type	Description
Against cold air	The internal fan will be off against cold air when the heat pump is heating.
De-ice cycle	The internal fan will be off against cold air when the heat pump is heating.
Anti-protection of internal battery	The compressor will be off to protect internal battery when the air conditioner operates in Cool mode.
Protect compressor	The air conditioner does not start operating immediately to protect the compressor of the outdoor unit after it has been started.

NOTE





- If the heat pump is operating in Heat mode, the de-ice cycle is actuated to remove frost from an outdoor unit that may have deposited at low temperatures.
- The internal fan is switched off automatically and restarted only after the de-ice cycle is completed.
- When the de-ice cycle is operating, it may generate strange sound. It is normal operation for product safety.





Troubleshooting



Refer to the following chart if the air conditioner operates abnormally. This may save time and unnecessary expenses.

Problem	Solution
The air conditioner does not operate immediately after it has been restarted.	<ul style="list-style-type: none"> Because of the protective mechanism, the appliance does not start operating immediately to keep the unit from overloading. The air conditioner will start in 3 minutes.
The air conditioner does not work at all.	<ul style="list-style-type: none"> Check that the power plug is properly connected. Insert the power plug into the wall socket correctly. Check if the circuit breaker is switched off. Check if there is a power failure. Check your fuse. Make sure it is not blown out.
The temperature does not change.	<ul style="list-style-type: none"> Check if you selected Fan mode. Press the  button on the remote control to select another mode.
The cool (or warm) air does not come out of the air conditioner.	<ul style="list-style-type: none"> Check if the set temperature is higher (lower) than the current temperature. Press the  or  button on the remote control to change the set temperature. Press the Temperature  or  button to increase or decrease the temperature. Check if the air filter is blocked by dirt. Clean the air filter every two weeks. Check if the air conditioner has just been turned on. If so, wait for 3 minutes.





Troubleshooting

Problem	Solution
The fan speed does not change.	<ul style="list-style-type: none"> Check if you selected Auto or Dry mode. The air conditioner automatically adjusts the fan speed to Auto in Auto/Dry mode.
Timer function is not set.	<ul style="list-style-type: none"> Check if you press the  and  button on the remote control after you have set the time.
Odours permeate in the room during operation.	<ul style="list-style-type: none"> Check if the appliance is running in a smoky area or if there is a smell entering from outside. Operate the air conditioner in Fan mode or open the windows to air out the room.
The air conditioner makes a bubbling sound.	<ul style="list-style-type: none"> A bubbling sound may be heard when the refrigerant is circulating through the compressor. Let the air conditioner operate in the selected mode.
Water is dripping from the air flow blades.	<ul style="list-style-type: none"> Check if the air conditioner has been cooling for an extended period of time with the air flow blades pointed downwards. Condensation may generate due to the difference in temperature.
Remote control is not working.	<ul style="list-style-type: none"> Check if your batteries are depleted. Make sure batteries are correctly installed. Make sure nothing is blocking your remote control sensor. Check that there are strong lighting apparatus near the air conditioner. Strong light that comes from fluorescent bulbs or neon signs may interrupt the electric waves.



Operation Ranges

The table below indicates the temperature and humidity ranges the air conditioner can be operated within. Refer to the table for efficient use.

MODE	OPERATIONAL TEMPERATURE		INDOOR HUMIDITY	IF OUT OF CONDITIONS
	INDOOR	OUTDOOR		
COOLING	18 °C to 32 °C	Depends on the specifications of the outdoor unit.	80 % or less	Condensation may occur on the indoor unit with risk to have either water blow off or drops on the floor.
HEATING	27 °C or less		-	Internal protection triggers and the air conditioner will stop.
DRYING	18 °C to 32 °C		80 % or less	Condensation may occur on the indoor unit with risk to have either water blow off or drops on the floor.

NOTE

- The standardized temperature for heating is 7 °C. If the outdoor temperature drops to 0 °C or below, the heating capacity can be reduced depending on the temperature condition.
- If the cooling operation is used at over 32°C (indoor temperature), it does not cool at its full capacity.



Technical specification

Model specification (Dimension and weight)

Dimension and weight			
Type	Model	Net dimension (WxDxH) (mm)	Net weight (kg)
Indoor unit	AM015KNTDEH/EU	820*285*227	8.0
	AM022KNTDEH/EU	820*285*227	8.0
	AM028KNTDEH/EU	820*285*227	8.5
	AM036KNTDEH/EU	820*285*227	8.5
	AM045KNTDEH/EU	1065*298*243	12.0
	AM056KNTDEH/EU	1065*298*243	12.0
	AM071KNTDEH/EU	1065*298*243	12.0
	AM015KNQDEH/EU	820*285*227	8.5
	AM022KNQDEH/EU	820*285*227	8.5
	AM028KNQDEH/EU	820*285*227	9.0
	AM036KNQDEH/EU	820*285*227	9.0
	AM045KNQDEH/EU	1065*298*243	12.5
	AM056KNQDEH/EU	1065*298*243	12.5
	AM071KNQDEH/EU	1065*298*243	12.5





Installation Procedure

Installing the indoor unit

Before fixing the installation plate to the wall or window frame, you must determine the position of the 65 mm hole through which the cable, pipe and hose pass to connect the indoor unit to the outdoor unit.

When facing the wall, the pipe and cable can be connected from the:

- Right
- Left
- Underside (right)
- Rear (right or left)

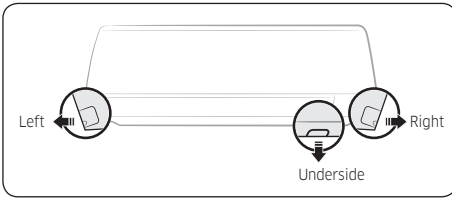

- 1 Determine the position of the pipe and drain hose hole as seen in the picture and drill the hole with an inner diameter of 65 mm so that it slants slightly downwards.

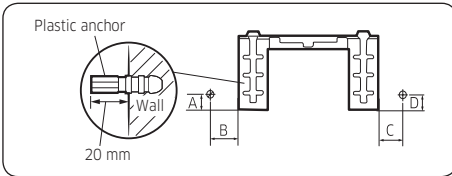

Pipe bundle hole: \varnothing 65 mm

(Unit : mm)

Model	A	B	C	D
015/022/028/036	30	96	38	30
045/056/071	38	126	70	38

- 2 If you fix the indoor unit to a wall, fix the installation plate to the wall giving attention to the weight of the indoor unit.

NOTE

- If you mount the plate to a concrete wall by using plastic anchors, make sure that gaps between the wall and the plate, created by projected anchor, are less than 20 mm.

- 3 If you fix the indoor unit to a window frame, follow 4 to 6.
- 4 Determine the positions of the wooden uprights to be attached to the window frame.
- 5 Attach the wooden uprights to the window frame giving attention to the weight of the indoor unit.
- 6 Attach the installation plate to the wooden uprights using tapping screw.

Performing leak test

Leak test

LEAK TEST WITH NITROGEN (before opening valves)

In order to detect basic refrigerant leaks, before recreating the vacuum and recirculating the R410A, it's responsible of installer to pressurize the whole system with nitrogen (using a pressure regulator) at a pressure above 4.1MPa (gauge).

LEAK TEST WITH R410A (after opening valves)

Before opening valves, discharge all the nitrogen into the system and create vacuum. After opening valves check leaks using a leak detector for refrigerant R410A.

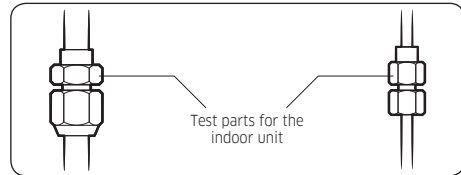

CAUTION

- Discharge all the nitrogen to create a vacuum and charge the system.





Installation Procedure

Wrapping the pipes with the insulation

After checking for gas leaks in the system, insulate the pipe, hose and cables. Then place the indoor unit on the installation plate.

- 1 To avoid condensation problems, place heat-resistant poly-ethylene foam separately around each refrigerant pipe in the lower part of the indoor unit.

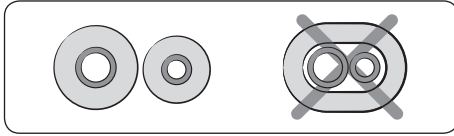

- 2 Wrap the refrigerant pipe and the drain hose in the rear of the indoor unit with the absorbent pad.

NOTE

- Wind the pipe and hose three times to the end of the indoor unit with the absorbent pad. (20mm interval)
- 3 Wind the pipe, assembly cable and drain hose with insulation tape.
 - 4 Place the bundle (the pipe, assembly cable and drain hose) in the lower part of the indoor unit carefully so it doesn't project from the rear of the indoor unit.

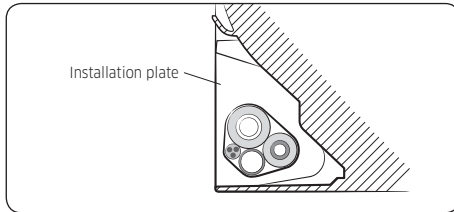

- 5 Hook the indoor unit to the installation plate and move the unit to the right and left until it is securely in place.
- 6 Wrap the rest of the pipe with vinyl tape.
- 7 Attach the pipe to the wall using clamps (optional).

Installing the drain hose

When installing the drain hose for the indoor unit, check if condensation draining is adequate. When passing the drain hose through the 65-mm hole drilled in the wall, check the following:

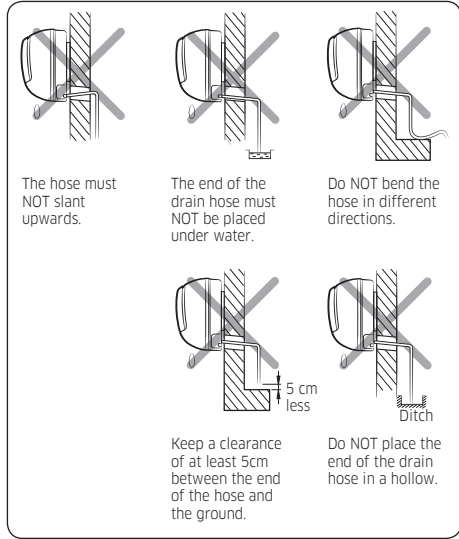

- 1 If necessary, connect the 2-meter extension drain hose to the drain hose.
- 2 If you use the extension drain hose, insulate the inside of the extension drain hose with a shield.
- 3 Fit the drain hose into 1 of 2 drain hose holes, then fix the end of the drain hose tightly with a clamp.

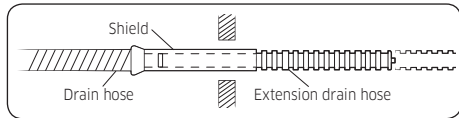

NOTE

- If you don't use the other drain hose hole, block it with a rubber stopper.





- 4 Pass the drain hose under the refrigerant pipe, keeping the drain hose tight.
- 5 Pass the drain hose through the hole in the wall. Check if it slants downwards as seen in the picture.

NOTE

- The hose will be fixed permanently into position after finishing the installation and the gas leak test; refer to page 12 for further details.
- **DO NOT WALL UP THE DRAIN HOSE CONNECTION!** Drain hose connection must be easy accessible and serviceable.

Optional: Changing direction of the drain hose

You can select the direction of the drain hose, depending on where you want to install the indoor unit.

- 1 Detach the rubber cap with the flyer.

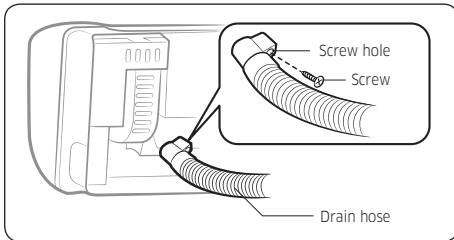

- 2 Detach the drain hose by pulling it and turning to the left.
- 3 Insert the drain hose by fixing it into the groove of the drain hose and the outlet of the drain pan.

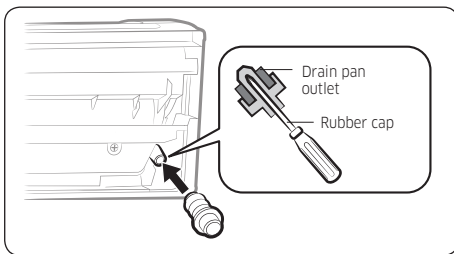

- 4 Attach the rubber cap with a screwdriver by turning it to the right until it fixes to the end of the groove.

Connecting the power and communication cables

- 1 Before wiring work, you must turn off all power source.
- 2 Indoor unit power should be supplied through the breaker (ELCB or MCCB+ELB) separated by the outdoor power.
 - ELCB:Earth Leakage Circuit Breaker
 - MCCB:Molded Case Circuit Breaker
 - ELB:Earth Leakage Breaker
- 3 The power cable should be used only copper wires.
- 4 Connect the power cable{1(L), 2(N)} among the units within maximum length and communication cable(F1, F2) each.
- 5 Cut the cable as like the following picture. The earth cable need to be longer than the power cable (1(L), 2(N)) by 100 mm.

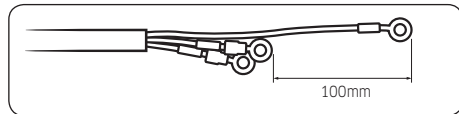

- 6 Connect the earth cable to the plate on the evaporator as like the following picture.

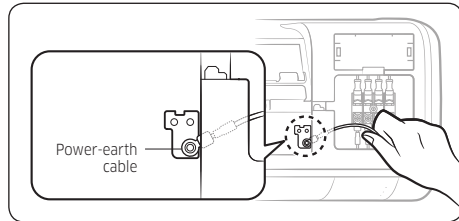



Installation Procedure

- 7 Connect F3, F4(for communication) wires at the back side of the indoor unit when installing the wired remote control.

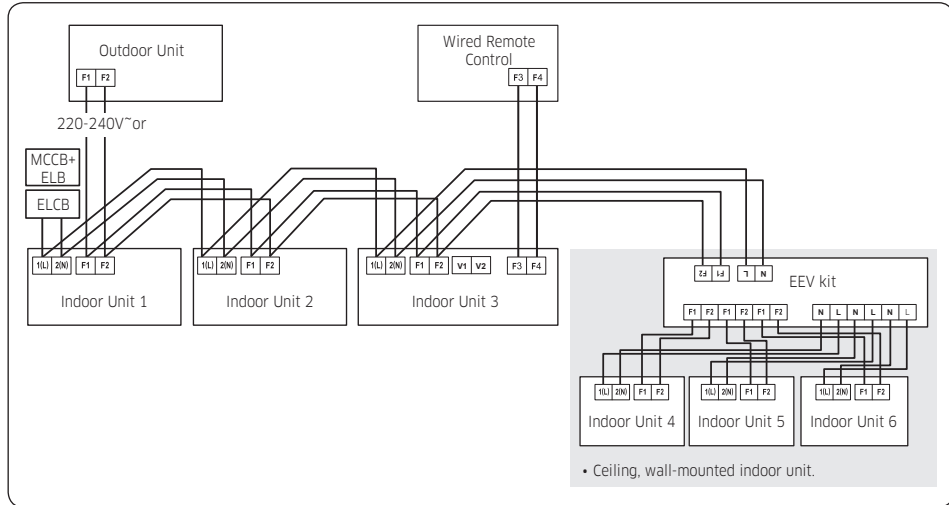

Installation part

- ELCB : Essential Installation
- The EEV Kit is optional component.

WARNING

- Power off before connecting any wires;Indoor PBA will be damaged while V1,V2,F3,F4 short each other.
- You must connect the earth cable. If earthing is not complete, electric shock or fire may occur.





Ring terminal selection

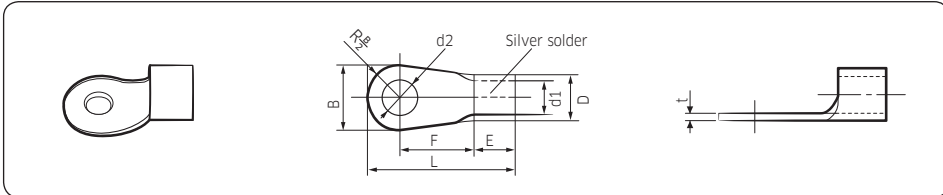

Nominal dimensions for cable (mm ²)	Nominal dimensions for screw (mm)	B		C		d1		E	F	L	d2		t
		Standard dimension (mm)	Allowance (mm)	Standard dimension (mm)	Allowance (mm)	Standard dimension (mm)	Allowance (mm)				Standard dimension (mm)	Allowance (mm)	
1.5	4	6.6	±0.2	3.4	+0.3 -0.2	1.7	±0.2	4.1	6	16	4.3	+0.2 0	0.7
	4	8											
2.5	4	6.6	±0.2	4.2	+0.3 -0.2	2.3	±0.2	6	6	17.5	4.3	+0.2 0	0.8
	4	8.5											
4	4	9.5	±0.2	5.6	+0.3 -0.2	3.4	±0.2	6	5	20	4.3	+0.2 0	0.9

Installation part

Specification of electronic wire

Power supply	MCCB	ELB or ELCB	Power cable	Earth cable	Communication cable
Max : 242V / Min : 198V	XA	XA, 30 mmA, 0.1 s	2.5 mm ²	2.5 mm ²	0.75~1.5 mm ²

- Refer to the unit nameplate for rating current.
- Decide the capacity of ELCB(or MCCB+ELB) by below formula.
- Power supply cords of parts of appliances for outdoor use shall not be lighter than polychloroprene sheathed flexible cord. (Code designation IEC:60245 IEC 57 / CENELEC: H05RN-F or IEC:60245 IEC 66 / CENELEC: H07RN-F)

The capacity of ELCB(or MCCB+ELB) X[A] = 1.25 X 1.1 X ΣAi

- X : The capacity of ELCB(or MCCB+ELB).
- ΣAi : Sum of Rating currents of each indoor unit.
- Refer to each installation manual about the rating current of indoor unit.

- Decide the power cable specification and maximum length within 10% power drop among indoor units.

$$\sum_{k=1}^n \left(\frac{\text{Coef} \times 35.6 \times L_k \times i_k}{1000 \times A_k} \right) < 10\% \text{ of input voltage[V]}$$

- coef: 1.55
- Lk: Distance among each indoor unit[m],
- Ak: Power cable specification[mm²]
- ik: Running current of each unit[A]



Installation Procedure

Setting an indoor unit address and installation option

Set the indoor unit address and installation option with remote control option. Set the each option separately since you cannot set the ADDRESS setting and indoor unit installation setting option at the same time. You need to set twice when setting indoor unit address and installation option.

Option setting procedure

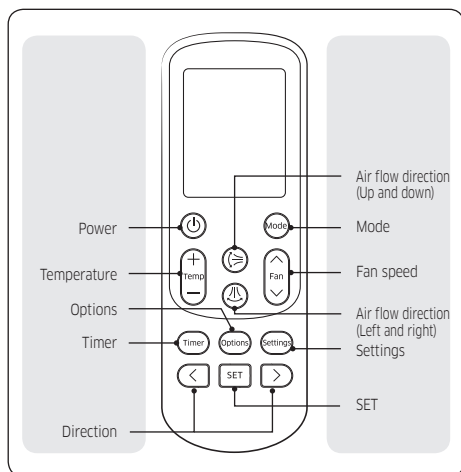

- 1 Remove batteries from the remote control.
- 2 Insert batteries and enter the option setting mode while pressing (High Temp button) and (Low Temp button).
- 3 Check if you have entered the option setting status.

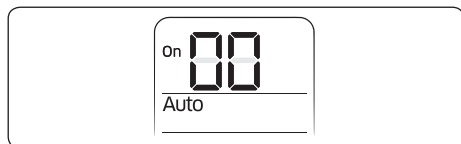

- 4 After entering the option setting status, select the option.







⚠ CAUTION

- Option setting is available from SEG1 to SEG 24
- SEG1, SEG7, SEG13, SEG19 are not set as page option.
- Set the SEG2~SEG6, SEG8~SEG12 as ON status and SEG14~18, SEG20~24 as OFF status.

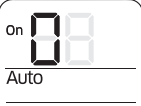
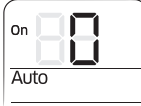
SEG1	SEG2	SEG3	SEG4	SEG5	SEG6
0	X	X	X	X	X
SEG7	SEG8	SEG9	SEG10	SEG11	SEG12
1	X	X	X	X	X
SEG13	SEG14	SEG15	SEG16	SEG17	SEG18
2	X	X	X	X	X
SEG19	SEG20	SEG21	SEG22	SEG23	SEG24
3	X	X	X	X	X

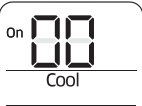
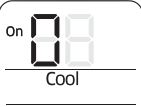
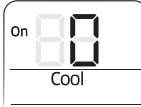
On (SEG1~12)	Off (SEG13~24)

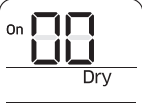
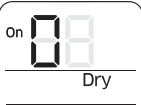
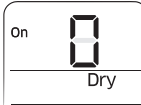

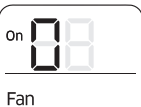
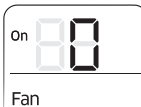





Option setting	Status
<p>1 Setting SEG2, SEG3 option</p> <p>a Press Low Fan button(V) to enter SEG2 value.</p> <p>b Press High Fan button(^) to enter SEG3 value.</p> <p>Each time you press the button, 0 → 1 → ... E → F will be selected in rotation.</p>	  <p>SEG2 SEG3</p>
<p>2 Setting Cool mode</p> <p> Press Mode button to be changed to Cool mode in the ON status.</p>	
<p>3 Setting SEG4, SEG5 option</p> <p>a Press Low Fan button(V) to enter SEG4 value.</p> <p>b Press High Fan button(^) to enter SEG5 value.</p> <p>Each time you press the button, 0 → 1 → ... E → F will be selected in rotation.</p>	  <p>SEG4 SEG5</p>
<p>4 Setting Dry mode</p> <p> Press Mode button to be changed to DRY mode in the ON status.</p>	
<p>5 Setting SEG6, SEG8 option</p> <p>a Press Low Fan button(V) to enter SEG6 value.</p> <p>b Press High Fan button(^) to enter SEG8 value.</p> <p>Each time you press the button, 0 → 1 → ... E → F will be selected in rotation.</p>	  <p>SEG6 SEG8</p>
<p>6 Setting Fan mode</p> <p> Press Mode button to be changed to FAN mode in the ON status.</p>	
<p>7 Setting SEG9, SEG10 option</p> <p>a Press Low Fan button(V) to enter SEG9 value.</p> <p>b Press High Fan button(^) to enter SEG10 value.</p> <p>Each time you press the button, 0 → 1 → ... E → F will be selected in rotation.</p>	  <p>SEG9 SEG10</p>

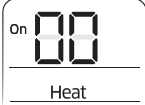
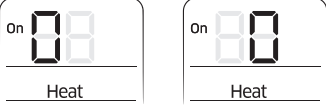

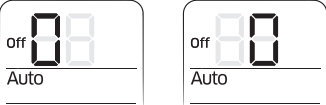

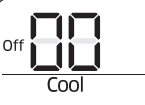
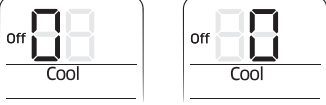

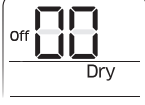
Installation Procedure

Option setting	Status
<p>8 Setting Heat mode</p> <p> Press Mode button to be changed to HEAT mode in the ON status.</p>	
<p>9 Setting SEG11, SEG12 option</p> <p>a Press Low Fan button(V) to enter SEG11 value.</p> <p>b Press High Fan button(Λ) to enter SEG12 value.</p> <p>Each time you press the button, 0 → 1 → ... E → F will be selected in rotation.</p>	
<p>10 Setting Auto mode</p> <p> Press Mode button to be changed to AUTO mode in the OFF status.</p>	
<p>11 Setting SEG14, SEG15 option</p> <p>a Press Low Fan button(V) to enter SEG14 value.</p> <p>b Press High Fan button(Λ) to enter SEG15 value.</p> <p>Each time you press the button, 0 → 1 → ... E → F will be selected in rotation.</p>	
<p>12 Setting Cool mode</p> <p> Press Mode button to be change to Cool mode in the OFF status.</p>	
<p>13 Setting SEG16, SEG17 option</p> <p>a Press Low Fan button(V) to enter SEG16 value.</p> <p>b Press High Fan button(Λ) to enter SEG17 value.</p> <p>Each time you press the button, 0 → 1 → ... E → F will be selected in rotation.</p>	
<p>14 Setting Dry mode</p> <p> Press Mode button to be change to Dry mode in the OFF status.</p>	



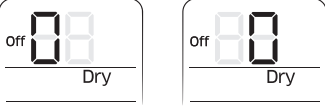
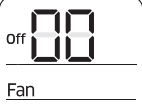
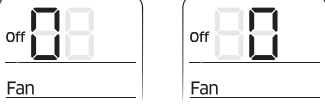
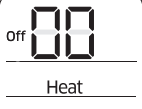

Option setting	Status
<p>15 Setting SEG18, SEG20 option</p> <p>a Press Low Fan button(V) to enter SEG18 value.</p> <p>b Press High Fan button(Λ) to enter SEG20 value.</p> <p>Each time you press the button, 0 → 1 → ... E → F will be selected in rotation.</p>	 <p>SEG18 SEG20</p>
<p>16 Setting Fan mode</p> <p>(Mode) Press Mode button to be change to Fan mode in the OFF status.</p>	 <p>Fan</p>
<p>17 Setting SEG21, SEG22 option</p> <p>a Press Low Fan button(V) to enter SEG21 value.</p> <p>b Press High Fan button(Λ) to enter SEG22 value.</p> <p>Each time you press the button, 0 → 1 → ... E → F will be selected in rotation.</p>	 <p>SEG21 SEG22</p>
<p>18 Setting Heat mode</p> <p>(Mode) Press Mode button to be change to HEAT mode in the OFF status.</p>	 <p>Heat</p>
<p>19 Setting SEG23, SEG24 mode</p> <p>a Press Low Fan button(V) to enter SEG23 value.</p> <p>b Press High Fan button(Λ) to enter SEG24 value.</p> <p>Each time you press the button, 0 → 1 → ... E → F will be selected in rotation.</p>	 <p>SEG23 SEG24</p>

5 After setting option, press (Mode) button to check whether the option code you input is correct or not.

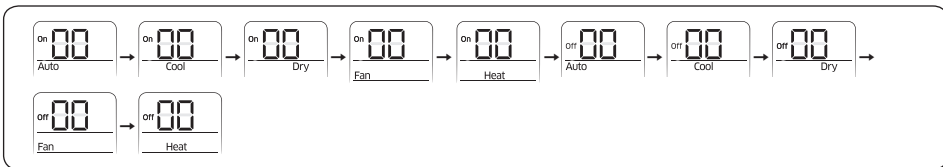

6 Press operation button (power icon) with the direction of remote control for set. For the correct option setting, you must input the option twice.

7 Check operation.

- Reset the indoor unit by pressing the RESET button of indoor unit or outdoor unit.
- Take the batteries out of the remote control and insert them again and then press the operation button.



Installation Procedure

Setting an indoor unit address (MAIN/RMC)

- 1 Check whether power is supplied or not.
 - When the indoor unit is not plugged in, there should be additional power supply in the indoor unit.
- 2 Before installing the indoor unit, assign an address to the indoor unit according to the air conditioning system plan.
- 3 Assign an indoor unit address by wireless remote control.

The initial setting status of indoor unit ADDRESS(MAIN/RMC) is "0A0000-100000-200000-300000".

Option No. : 0AXXXX-1XXXXX-2XXXXX-3XXXXX

Option	SEG1		SEG2		SEG3		SEG4		SEG5		SEG6			
Explanation	PAGE		Mode		Setting Main address		100-digit of indoor unit address		10-digit of indoor unit		The unit digit of an indoor unit			
Indication and Details	Indication	Details	Indication	Details	Indication	Details	Indication	Details	Indication	Details	Indication	Details		
	0		A		0	No Main address	0~9	100-digit	0~9	10-digit	0~9	A unit digit		
					1	Main address setting mode								
Option	SEG7		SEG8		SEG9		SEG10		SEG11		SEG12			
Explanation	PAGE		-		Setting RMC address		-		Group channel(*16)		Group address			
Indication and Details	Indication	Details			Indication	Details			Indication	Details	Indication	Details	Indication	Details
	1				0	No RMC address			RMC1	0~F	RMC2	0~F		
			1	RMC address setting mode										

CAUTION

- When A~F is entered to SEG5~6, the indoor unit MAIN ADDRESS is not changed.
- If you set the SEG 3 as 0, the indoor unit will maintain the previous MAIN ADDRESS even if you input the option value of SEG5~6.
- If you set the SEG 9 as 0, the indoor unit will maintain previous RMC ADDRESS even if you input the option value of SEG11~12.
- You cannot set SEG11 and SEG12 as F value at the same time.



Setting an indoor unit installation option (suitable for the condition of each installation location)

- Check whether power is supplied or not.
 - When the indoor unit is not plugged in, there should be additional power supply in the indoor unit.
- Set the installation option according to the installation condition of an air conditioner.
 - The default setting of an indoor unit installation option is 020010-100000- 200000-300000.
 - Individual control of a remote control(SEG20) is the function that controls an indoor unit individually when there is more than one indoor unit.
- Set the indoor unit option by wireless remote control.

O2 series installation option

SEG1	SEG2	SEG3	SEG4	SEG5	SEG6
0	2	-	External room temperature sensor / Minimizing fan operation when thermostat is off	Central control	FAN RPM compensation
SEG7	SEG8	SEG9	SEG10	SEG11	SEG12
1	-	-	-	EEV Step when heating stops	-
SEG13	SEG14	SEG15	SEG16	SEG17	SEG18
2	External control	External control output / External heater On or Off signal	S-Plasma ion	Buzzer	Number of hours using filter
SEG19	SEG20	SEG21	SEG22	SEG23	SEG24
3	Individual control of a remote control	Heating setting compensation / Removing condensated water in heating mode	EEV Step of stopped unit during oil return/defrost mode	-	-

- When setting the option other than above SEG values, the option will be set as "0".
- SEG5 central control option is basically set as 1 (Use), so you don't need to set the central control option additionally.
However, if the central control is not connected but it doesn't indicate an error message, you need to set the central control option as 0 (Disuse) to exclude the indoor unit from the central control.
- The external output of SEG15 is generated by MIM-B14 connection. (Refer to the manual of MIM-B14.)

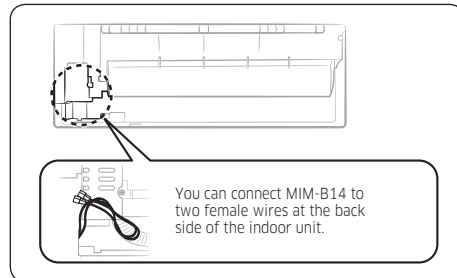

Installation Procedure

O2 series installation option(Detailed)

Option No. : 02XXXX-1XXXXX-2XXXXX-3XXXXX

Installation part

Option	SEG1		SEG2		SEG3		SEG4			SEG5		SEG6					
Explanation	PAGE		Mode		Use of robot cleaning		Use of external room temperature sensor / Minimizing fan operation when thermostat is off			Use of central control		FAN RPM compensation					
Indication and Details	Indication	Details	Indication	Details	Indication	Details	Indication	Details		Indication	Details	Indication	Details				
								Use of External room temperature sensor	Minimizing fan operation when thermostat is off								
	0	2	0	Disuse	1	Use	0	Disuse	Disuse	0	Disuse	0	Disuse				
							1	Use	Disuse			1	RPM compensation				
							2	Disuse	Use (*1)			1	Use	2	High ceiling KIT		
3	Use	Use (*1)															
Option	SEG7		SEG8		SEG9		SEG10			SEG11		SEG12					
Explanation	PAGE									EEV Step when heating stops							
Indication and Details	Indication	Details					Indication	Details		Indication	Details		Indication	Details			
											0	Default value					
											1	Stopped Unit's Noise Decreasing Setting					
										2*B	Running Unit's Noise Decreasing Setting(*3)						
Option	SEG13		SEG14		SEG15		SEG16			SEG17		SEG18					
Explanation	PAGE		Use of external control		Setting the output of external control / External heater On/Off signal		S-Plasma ion			Buzzer control		Hours of filter usage					
Indication and Details	Indication	Details	Indication	Details	Indication	Details		Indication	Details	Indication	Details	Indication	Details				
						Setting the output of external control	External heater On/Off signal										
	2			0	Disuse	0	Thermo on	-	0	Disuse	0	Use buzzer	2	1000 Hour			
				1	ON/OFF control	1	Operation on	-									
				2	OFF control	2	-	Use (*4)							1	Use	6
3				Window ON/OFF control	3	-	Use (*4)										



Option	SEG19		SEG20		SEG21			SEG22		SEG23		SEG24		
Explanation	PAGE		Individual control of a remote control		Heating setting compensation / Removing condensated water in heating mode			EEV Step of stopped unit during oil return/defrost mode						
Indication and Details	Indication	Details	Indication	Details	Indication	Details		Indication	Details					
						Heating Setting Compensation	Removing Condensated Water in Heating Mode							
3	0 or 1	channel 1	0	Default (*5)	Disuse	0	Default value	1	Oil return or Noise decreasing in defrost mode					
			2	2 °C	Disuse									
			3	5 °C	Disuse									
			4	channel 4	3								Default (*5)	Use (*6)
					4								2 °C	Use (*6)
					5								5 °C	Use (*6)

Installation part

(*) Advanced function: Controlling cooling/heating current or power saving with motion detect.

(*1) Minimizing fan operation when thermostat is off

- Fan operates for 20 seconds at an interval of 5 minutes in heat mode.

(*2) 1: Fan is turned on continually when the hot water heater is turned on, 3: Fan is turned off when the hot water heater is turned on with cooling only indoor unit

Cooling only indoor unit: To use this option, install the Mode Select switch(MCM-C200) on the outdoor unit and fix it as cool mode.

(*3) It is only for wall-mounted indoor unit with EEV Integrated. If any design condition meets either of the following below, please set SEG11 to "7".

- a The total number of wall-mounted indoor units with EEV Integrated in one (modular) system is more than 20.
- b The total number of wall-mounted indoor units with EEV Integrated in one (modular) system is more than "the total of one(modular) system's capacity(kW) / 2" ("the total of one(modular) system's capacity(BTU/h) / 6800").
ex) Outdoor capacity 28kW → 28 / 2 = 14. The total number of wall-mounted indoor units with EEV Integrated in one (modular) system is more than 14.





Installation Procedure

Please refer to the EEV step table below for the system (for heating) at stop.

Indication			0	2	3	4	5	6	7	8	9	A	B
Stopped Unit's EEV step	Wall Mounted With EEV	A Step	100	90	100	110	120	130	160	200	250	300	400
		B Step	125	160	160	160	160	160	160	200	250	300	400
	Other Indoor Units except for wall mounted with EEV	Default	No Function										

- (*4) When the following 2 or 3 is used as external heater On/Off signal, the signal for monitoring external contact control will not be output.
- 2: Fan is turned on continually when the external heater is turned on,
 - 3: Fan is turned off when the external heater is turned on with cooling only indoor unit
Cooling only indoor unit: To use this option, install the Mode Select switch(MCM-C200) on the outdoor unit and fix it as cool mode.
 - If Fan is set to off for cooling only indoor unit by setting the SEG9=3 or SEG15=3, you need to use an external sensor or wired remote control sensor to detect indoor temperature exactly.
- (*5) Default setting value
- 4Way Cassette, Mini 4Way Cassette: 5 °C
 - Other indoor units: 2 °C
- (*6) This function can be applied to 4 Way Cassette and Mini 4 Way Cassette only. If the air conditioner operates the heating mode immediately after finishing the cooling mode, the condensated water in the drain pan becomes water vapor by the heat of the indoor unit heat exchanger. Since the water vapor might be condensed on the indoor unit, which may fall into a living space, use this function to get rid of the water vapor out of the indoor unit by operating the fan (for maximum 20 minutes) even when the indoor unit is turned off after cooling mode is turned to heating mode.



05 series installation option

SEG1	SEG2	SEG3	SEG4	SEG5	SEG6
0	5	Use of Auto Change Over for HR only in Auto mode	(When setting SEG3) Standard heating temp. Offset	(When setting SEG3) Standard cooling temp. Offset	(When setting SEG3) Standard for mode change Heating → Cooling
SEG7	SEG8	SEG9	SEG10	SEG11	SEG12
1	(When setting SEG3) Standard for mode change Cooling → Heating	(When setting SEG3) Time required for mode change	Compensation option for Long pipe or height difference between indoor units	MTC	-
SEG13	SEG14	SEG15	SEG16	SEG17	SEG18
2	Set to variable breeze	-	-	-	Control variables when using hot water / external heater
SEG19	SEG20	SEG21	SEG22	SEG23	SEG24
3	-	-	-	-	-

Installation part

05 series installation option(Detailed)

Option No. : 02XXXX-1XXXXX-2XXXXX-3XXXXX

Option	SEG1		SEG2		SEG3		SEG4		SEG5		SEG6		
Explanation	PAGE		MODE		Use of Auto Change Over for HR only in Auto mode		(When setting SEG3) Standard heating temp. Offset		(When setting SEG3) Standard cooling temp. Offset		(When setting SEG3) Standard for mode change Heating → Cooling		
Indication and Details	Indication	Details	Indication	Details	Indication	Details	Indication	Details	Indication	Details	Indication	Details	
	0	0		5		0	Follow product option	0	0	0	0	0	1
						1	0.5	1	0.5	1	1.5		
						2	1	2	1	2	2		
						3	1.5	3	1.5	3	2.5		
						4	2	4	2	4	3		
						5	2.5	5	2.5	5	3.5		
						6	3	6	3	6	4		
7						3.5	7	3.5	7	4.5			



Installation Procedure

Installation part

Option	SEG7		SEG8		SEG9		SEG10		SEG11		SEG12			
Explanation	PAGE		(When setting SEG3) Standard for mode changing Cooling → Heating mode		(When setting SEG3) Time required for mode change		Compensation option for Long pipe or height difference between indoor units		MTC					
Indication and Details	Indication	Details	Indication	Details	Indication	Details	Indication	Details	Indication	Details				
	1	0	1	0	5 min.	0	Use default value	0	Disuse					
		1	1.5	1	7 min.	1	1) Height difference ¹⁾ is more than 30m or 2) Distance ²⁾ is longer than 110m	1	Use (1 sec)					
		2	2	2	9 min.			2	Use (2 sec)					
		3	2.5	3	11 min.			3	Use (3 sec)					
		4	3	4	13 min.			4	Use (4 sec)					
		5	3.5	5	15 min.			5	Use (5 sec)					
		6	4	6	7	30 min.	2	1) Height difference ¹⁾ is 15~30m or 2) Distance ²⁾ is 50~110m	6					Use (6 sec)
		7	4.5						7					Use (7 sec)
									8					Use (8 sec)
			9						Use (9 sec)					
		A	Use (10 sec)											
		B												
		C												
		D												
		E												
		F												
Option	SEG13		SEG14		SEG15		SEG16		SEG17		SEG18			
Explanation			Set to variable breeze								Control variables when using hot water / external heater			
Indication and Details			Indication	Details							Indication	Details		
			0	0							0	At the same time as thermo on	No delay	
			1	1							1	At the same time as thermo on	10 minutes	
			2	2							2	At the same time as thermo on	20 minutes	
			3	3							3	1.5 °C	No delay	
			4	4							4	1.5 °C	10 minutes	
			5	5							5	1.5 °C	20 minutes	
			6	6							6	3.0 °C	No delay	
			7	7							7	3.0 °C	10 minutes	
			8	8							8	3.0 °C	20 minutes	
			9	9							9	4.5 °C	No delay	
			A	10							A	4.5 °C	10 minutes	
			B	11							B	4.5 °C	20 minutes	
			C	12							C	6.0 °C	No delay	
			D	13							D	6.0 °C	10 minutes	
		E	14							E	6.0 °C	20 minutes		
		F	Unavailable											



- (*1) Height difference : The difference of the height between the corresponding indoor unit and the indoor unit installed at the lowest place. For example, When the indoor unit is installed 40m higher than the indoor unit installed at the lowest place, select the option "1".
- (*2) Distance : The difference between the pipe length of the indoor unit installed at farthest place from an outdoor unit and the pipe length of the corresponding indoor unit from an outdoor unit. For example, when the farthest pipe length is 100 m and the corresponding indoor unit is 40 m away from an outdoor unit, select the option "2". (100 - 40 = 60m)
- (*3) Heater operation when the SEG9 of O2 series installation option is set to using hot water heater or when SEG15 is set to using external heater
- e.g. 1) Setting O2 series SEG9 = "1" / Setting O5 series SEG18 = "0": Hot water heater is turned on at the same time as the heating thermostat is on, and turned off when the heating thermostat is off.
- e.g. 2) Setting O2 series SEG15 = "2" / Setting O5 series SEG18 = "A":
- Room temp. \leq set temp. + f(heating compensation temp.)
External heater is turned on when the temperature is maintained as 4.5 °C for 10 minutes.
 - Room temp. $>$ set temp. + f(heating compensation temp.)
External heater is turned off when the temperature is maintained as 4.5 °C + 1 °C (1 °C is the Hysteresis for On/Off selection)

SEG 3, 4, 5, 6, 8, 9 additional information

When the SEG 3 is set as "1" and follow Auto Change Over for HR only operation, it will operate as follows.

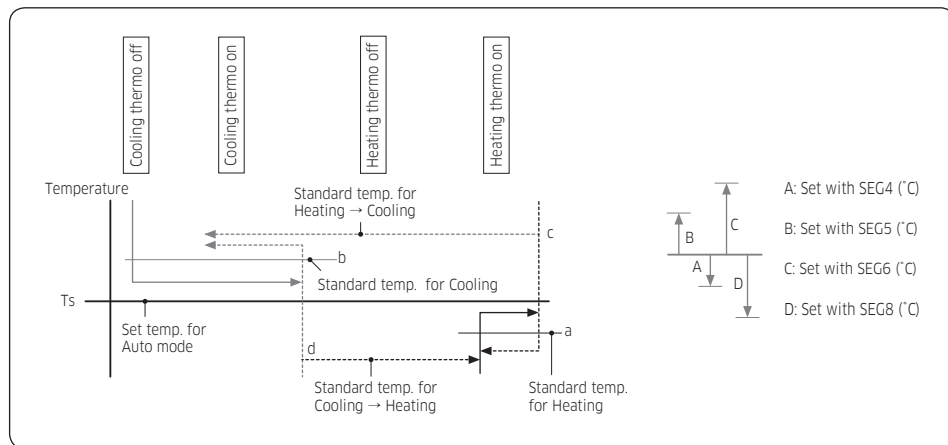

Cooling/Heating mode can be changed when Thermo Off status is maintained during the time with SEG9.





Installation Procedure

Changing a particular option

You can change each digit of set option.

Option	SEG1		SEG2		SEG3		SEG4		SEG5		SEG6	
Explanation	PAGE		MODE		The option mode you want to change		The tens' digit of an option SEG you will change		The unit digit of an option SEG you will change		Changed value	
Indication and Details	Indication	Details	Indication	Details	Indication	Details	Indication	Details	Indication	Details	Indication	Details
		0		D		Option mode	1~6	Tens' digit of SEG	0~9	Unit digit of SEG	0~9	The changed value

NOTE

- When changing a digit of an indoor unit address setting option, set the SEG3 as 'A'.
- When changing a digit of indoor unit installation option, set the SEG3 as '2'.

Ex) When setting the 'buzzer control' into disuse status.

Option	SEG1		SEG2		SEG3		SEG4		SEG5		SEG6	
Explanation	PAGE		MODE		The option mode you want to change		The tens' digit of an option SEG you will change		The unit digit of an option SEG you will change		Changed value	
Indication	0		D		2		1		7		1	

CAUTION

- If you are using heat pump model, mixed operation mode (two or more indoor units operating in different operation mode simultaneously) is not available when the indoor units are connected to same outdoor unit. If you set the master indoor unit with a remote control, outdoor unit will operate in the mode which was set in the master indoor unit.



Memo

Installation part



QUESTIONS OR COMMENTS?

COUNTRY	CALL	OR VISIT US ONLINE AT
UK	0330 SAMSUNG (7267864)	www.samsung.com/uk/support
EIRE	0818 717100	www.samsung.com/ie/support
GERMANY	0180 6 SAMSUNG bzw. 0180 6 7267864* (*0,20 €/Anruf aus dem dt. Festnetz, aus dem Mobilfunk max. 0,60 €/Anruf) 0180 6 M SAMSUNG bzw. 0180 6 67267864* (*0,20 €/Anruf aus dem dt. Festnetz, aus dem Mobilfunk max. 0,60 €/Anruf)	www.samsung.com/de/support
FRANCE	01 48 63 00 00	www.samsung.com/fr/support
ITALIA	800-SAMSUNG (800.7267864)	www.samsung.com/it/support
SPAIN	0034902172678 0034902167267	www.samsung.com/es/support
PORTUGAL	808 20 7267	www.samsung.com/pt/support
LUXEMBURG	261 03 710	www.samsung.com/be_fr/support
NETHERLANDS	088 90 90 100	www.samsung.com/nl/support
BELGIUM	02-201-24-18	www.samsung.com/be/support (Dutch) www.samsung.com/be_fr/support (French)
NORWAY	815 56480	www.samsung.com/no/support
DENMARK	70 70 19 70	www.samsung.com/dk/support
FINLAND	030-6227 515	www.samsung.com/fi/support
SWEDEN	0771 726 7864 (0771-SAMSUNG)	www.samsung.com/se/support
POLAND	801-172-678* lub +48 22 607-93-33* Dedykowana infolinia do obsługi zapytań dotyczących telefonów komórkowych: 801-672-678* lub +48 22 607-93-33* * (koszt połączenia według taryfy operatora)	www.samsung.com/pl/support
HUNGARY	*0680SAMSUNG (0680-726-786) 0680PREMIUM (0680-773-648)	www.samsung.com/hu/support
AUSTRIA	0800-SAMSUNG (0800-7267864) [Only for Premium HA] 0800-366661 [Only for Dealers] 0810-112233	www.samsung.com/at/support
SWITZERLAND	0800 726 78 64 (0800-SAMSUNG)	www.samsung.com/ch/support (German) www.samsung.com/ch_fr/support (French)
CZECH	800 - SAMSUNG (800-726786)	www.samsung.com/cz/support
SLOVAKIA	0800 - SAMSUNG (0800-726 786)	www.samsung.com/sk/support
CROATIA	072 726 786	www.samsung.com/hr/support
BOSNIA	055 233 999	www.samsung.com/support
MONTENEGRO	020 405 888	www.samsung.com/support
SLOVENIA	080 697 267 (brezplačna številka)	www.samsung.com/si
SERBIA	011 321 6899	www.samsung.com/rs/support
BULGARIA	*3000 Цена в мрежата 0800 111 31 - Безплатна телефонна линия	www.samsung.com/bg/support
ROMANIA	*8000 (apel in retea) 08008-726-78-64 (08008-SAMSUNG) Apel GRATUIT	www.samsung.com/ro/support
CYPRUS	8009 4000 only from landline, toll free	www.samsung.com/gr/support
GREECE	80111-SAMSUNG (80111 726 7864) only from land line (+30) 210 6897691 from mobile and land line	
LITHUANIA	8-800-77777	www.samsung.com/lt/support
LATVIA	8000-7267	www.samsung.com/lv/support
ESTONIA	800-7267	www.samsung.com/ee/support

SAMSUNG ELECTRONICS CO., LTD.

No.501 Suhong East Road,Suzhou Industrial Park,Jiangsu Province,P.R.China

Samsung Electronics (UK) Ltd, Euro QA Lab.

Blackbushe Business Park, Saxony Way, Yateley, Hampshire. GU46 6GG United Kingdom



DB68-06415A-00

