

Contents

PREPARATION

Safety precautions.....	3
Viewing your air conditioner.....	11

BASIC FUNCTION

Wire Remote Controller (Optional).....	12
--	----

OTHERS

Appendix.....	16
Model specification (weight and dimension).....	17

INSTALLATION

Indoor Unit Installation.....	18
Performing Leak Test & Insulation.....	19
Drain pipe and Drain Hose Installation.....	21
Wiring Work.....	24
Setting an indoor unit address and installation option.....	27



Correct Disposal of This Product (Waste Electrical & Electronic Equipment)

(Applicable in countries with separate collection systems)

This marking on the product, accessories or literature indicates that the product and its electronic accessories (e.g. charger, headset, USB cable) should not be disposed of with other household waste at the end of their working life. To prevent possible harm to the environment or human health from uncontrolled waste disposal, please separate these items from other types of waste and recycle them responsibly to promote the sustainable reuse of material resources.

Household users should contact either the retailer where they purchased this product, or their local government office, for details of where and how they can take these items for environmentally safe recycling.

Business users should contact their supplier and check the terms and conditions of the purchase contract. This product and its electronic accessories should not be mixed with other commercial wastes for disposal.







For information on Samsung's environmental commitments and product specific regulatory obligations e.g. REACH visit: samsung.com/uk/aboutsamsung/samsungelectronics/corporatecitizenship/data_corner.html

Safety precautions

Before using your new air conditioner, please read this manual thoroughly to ensure that you know how to safely and efficiently operate the extensive features and functions of your new appliance.

Because the following operating instructions cover various models, the characteristics of your air conditioner may differ slightly from those described in this manual. If you have any questions, call your nearest contact center or find help and information online at www.samsung.com.

Important safety symbols and precautions:

 WARNING	Hazards or unsafe practices that may result in severe personal injury or death.
 CAUTION	Hazards or unsafe practices that may result in minor personal injury or property damage.
	Follow directions.
	Do NOT attempt.
	Make sure the machine is grounded to prevent electric shock.
	Unplug the power plug from the wall socket.
	Do NOT disassemble.

Safety precautions

FOR INSTALLATION WARNING

! Use the power line with the power specifications of the product or higher and use the power line for this appliance only. In addition, do not use an extension line.

- ▶ Extending the power line may result in electric shock or fire.
- ▶ Do not use an electric transformer. It may result in electric shock or fire.
- ▶ If the voltage/frequency/rated current condition is different, it may cause fire.

The installation of this appliance must be performed by a qualified technician or service company.

- ▶ Failing to do so may result in electric shock, fire, explosion, problems with the product, or injury.

Install a switch and circuit breaker dedicated to the air conditioner.

- ▶ Failing to do so may result in electric shock or fire.

Fix the outdoor unit firmly so that the electric part of the outdoor unit is not exposed.

- ▶ Failing to do so may result in electric shock or fire.

⊘ Do not install this appliance near a heater, inflammable material. Do not install this appliance in a humid, oily or dusty location, in a location exposed to direct sunlight and water (rain drops). Do not install this appliance in a location where gas may leak.

- ▶ This may result in electric shock or fire.

Never install the outdoor unit in a location such as on a high external wall where it could fall.

- ▶ If the outdoor unit falls, it may result in injury, death or property damage.



- ⚠ **This appliance must be properly grounded. Do not ground the appliance to a gas pipe, plastic water pipe, or telephone line.**
 - ▶ Failure to do so may result in electric shock, fire, an explosion, or other problems with the product.
 - ▶ Never plug the power cord into a socket that is not grounded correctly and make sure that it is in accordance with local and national codes.

FOR INSTALLATION CAUTION

- ⚠ **Install your appliance on a level and hard floor that can support its weight.**
 - ▶ Failing to do so may result in abnormal vibrations, noise, or problems with the product.
- Install the draining hose properly so that water is drained correctly.**
 - ▶ Failing to do so may result in water overflowing and property damage.
- When installing the outdoor unit, make sure to connect the draining hose so that draining is performed correctly.**
 - ▶ The water generated during the heating operation by the outdoor unit may overflow and result in property damage. In particular, in winter, if a block of ice falls, it may result in injury, death or property damage.

Safety precautions

FOR POWER SUPPLY WARNING

-  When the circuit breaker is damaged, contact your nearest service center.
-  Do not pull or excessively bend the power line. Do not twist or tie the power line. Do not hook the power line over a metal object, place a heavy object on the power line, insert the power line between objects, or push the power line into the space behind the appliance.
 - ▶ This may result in electric shock or fire.

FOR POWER SUPPLY CAUTION

-  When not using the air conditioner for a long period of time or during a thunder/lightning storm, cut the power at the circuit breaker.
 - ▶ Failing to do so may result in electric shock or fire.

FOR USING WARNING

-  If the appliance is flooded, please contact your nearest service center.
 - ▶ Failing to do so may result in electric shock or fire.
- If the appliance generates a strange noise, a burning smell or smoke, unplug the power plug immediately and contact your nearest service center.**
- ▶ Failing to do so may result in electric shock or fire.
- In the event of a gas leak (such as propane gas, LP gas, etc.), ventilate immediately without touching the power line.**
- Do not touch the appliance or power line.**
- ▶ Do not use a ventilating fan.
 - ▶ A spark may result in an explosion or fire.
- To reinstall the air conditioner, please contact your nearest service center.**

- ▶ Failing to do so may result in problems with the product, water leakage, electric shock, or fire.
- ▶ A delivery service for the product is not provided. If you reinstall the product in another location, additional construction expenses and an installation fee will be charged.
- ▶ Especially, when you wish to install the product in an unusual location such as in an industrial area or near the seaside where it is exposed to the salt in the air, please contact your nearest service center.

⊘ Do not touch the circuit breaker with wet hands.

- ▶ This may result in electric shock.

Do not strike or pull the air conditioner with excessive force.

- ▶ This may result in fire, injury, or problems with the product.

Do not place an object near the outdoor unit that allows children to climb onto the machine.

- ▶ This may result in children seriously injuring themselves.

Do not turn the air conditioner off with the circuit breaker while it is operating.

- ▶ Turning the air conditioner off and then on again with the circuit breaker may cause a spark and result in electric shock or fire.

After unpacking the air conditioner, keep all packaging materials well out of the reach of children, as packaging materials can be dangerous to children.

- ▶ If a child places a bag over its head, it may result in suffocation.

Safety precautions

FOR USING



WARNING

- ⊘ **Do not insert your fingers or foreign substances into the outlet when the air conditioner is operating or the front panel is closing.**
 - ▶ Take special care that children do not injure themselves by inserting their fingers into the product.

Do not touch the front panel with your hands or fingers during the heating operation.

 - ▶ This may result in electric shock or burns.

Do not insert your fingers or foreign substances into the air inlet/outlet of the air conditioner.

 - ▶ Take special care that children do not injure themselves by inserting their fingers into the product.

Do not use this air conditioner for long periods of time in badly ventilated locations or near infirm people.

 - ▶ Since this may be dangerous due to a lack of oxygen, open a window at least once an hour.
- ⚠ **If any foreign substance such as water has entered the appliance, cut the power by unplugging the power plug and turning the circuit breaker off and then contact your nearest service center.**
 - ▶ Failing to do so may result in electric shock or fire.
- ⊘ **Do not attempt to repair, disassemble, or modify the appliance yourself.**
 - ▶ Do not use any fuse (such as cooper, steel wire, etc.) other than the standard fuse.
 - ▶ Failing to do so may result in electric shock, fire, problems with the product, or injury.



Do not place objects or devices under the indoor unit.

- ▶ Water dripping from the indoor unit may result in fire or property damage.

Check that the installation frame of the outdoor unit is not broken at least once a year.

- ▶ Failing to do so may result in injury, death or property damage.

Max current is measured according to IEC standard for safety and current is measured according to ISO standard for energy efficiency.



Do not apply a strong impact to the remote controller and do not disassemble the remote controller.

Do not touch the pipes connected with the product.

- ▶ This may result in burns or injury.

Do not use this air conditioner to preserve precision equipment, food, animals, plants or cosmetics, or for any other unusual purposes.

- ▶ This may result in property damage.

Avoid directly exposing humans, animals or plants from the air flow from the air conditioner for long periods of time.

- ▶ This may result in harm to humans, animals or plants.

This appliance is not intended for use by persons (including children) with reduced physical, sensory or mental capabilities, or lack of experience and knowledge, unless they have been given supervision or instruction concerning use of the appliance by a person responsible for their safety. Children should be supervised to ensure that they do not play with the appliance.

For use in Europe: This appliance can be used by children aged from 8 years and above and persons with reduced physical, sensory or mental capabilities or lack of experience and knowledge if they have been given supervision or instruction concerning use of the appliance in a safe way and understand the hazards involved. Children shall not play with the appliance. Cleaning and user maintenance shall not be made by children without supervision.

Safety precautions

FOR CLEANING



WARNING

⊘ Do not clean the appliance by spraying water directly onto it. Do not use benzene, thinner or alcohol to clean the appliance.

- ▶ This may result in discoloration, deformation, damage, electric shock or fire.

Before cleaning or performing maintenance, unplug the air conditioner from the wall socket and wait until the fan stops.

- ▶ Failing to do so may result in electric shock or fire.

FOR CLEANING



CAUTION

ⓘ Take care when cleaning the surface of the heat exchanger of the outdoor unit since it has sharp edges.

- ▶ To avoid cutting your fingers, wear thick cotton gloves when cleaning it.

⊘ Do not clean the inside of the air conditioner by yourself.

- ▶ For cleaning inside the appliance, contact your nearest service center.
- ▶ When cleaning the internal filter, refer to the descriptions in the 'Cleaning and maintaining the air conditioner' section.
- ▶ Failure to do may result in damage, electric shock or fire.

Viewing your air conditioner

Congratulations on the purchase of the air conditioner. We hope you enjoy the features of your air conditioner and stay cool or warm with optimal efficiency.

Please read the user manual to get started and to make the best use of the air conditioner.

Air Duct Type

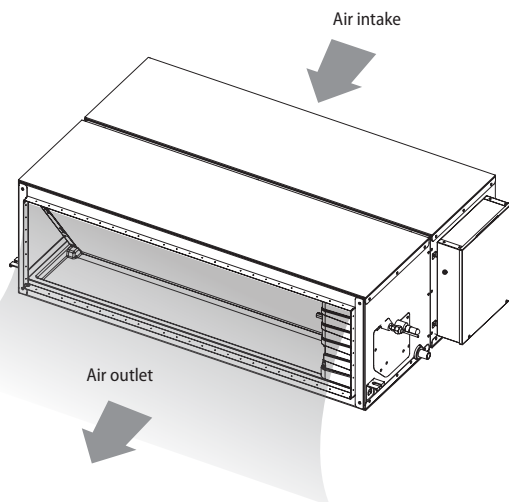

NOTE

- Your air conditioner may look slightly different from the illustration shown above depending on your model.

Wire Remote Controller (Optional)

Display

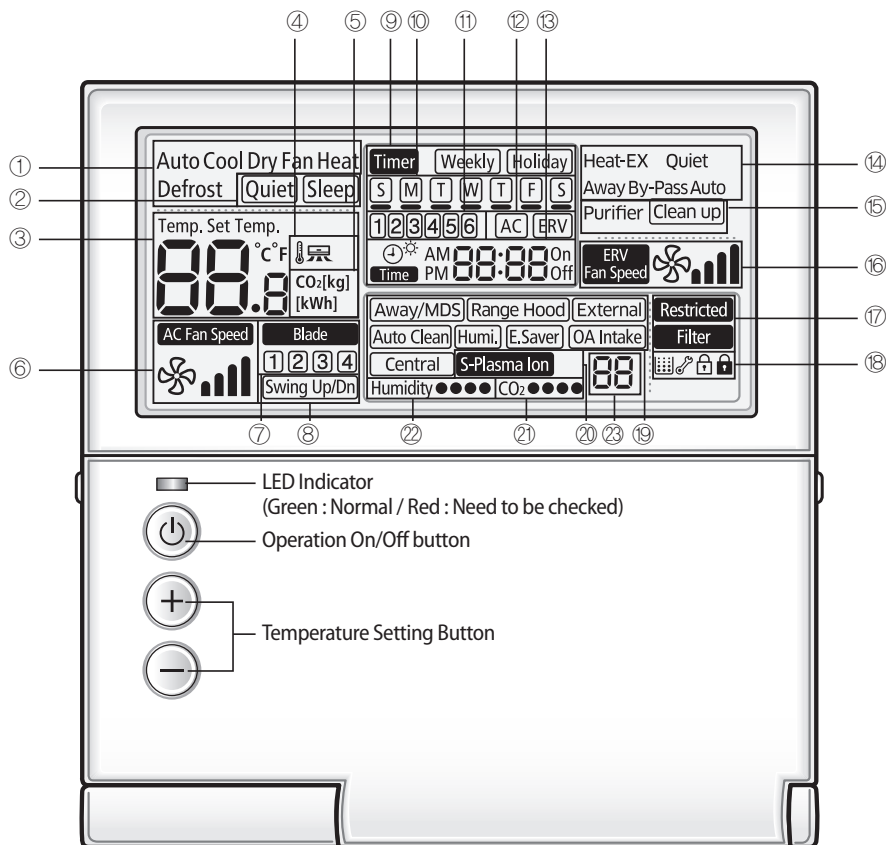

• Without opening the cover of your Wired Remote Controller, you can turn the air-conditioner power On/Off or set the desired temperature.







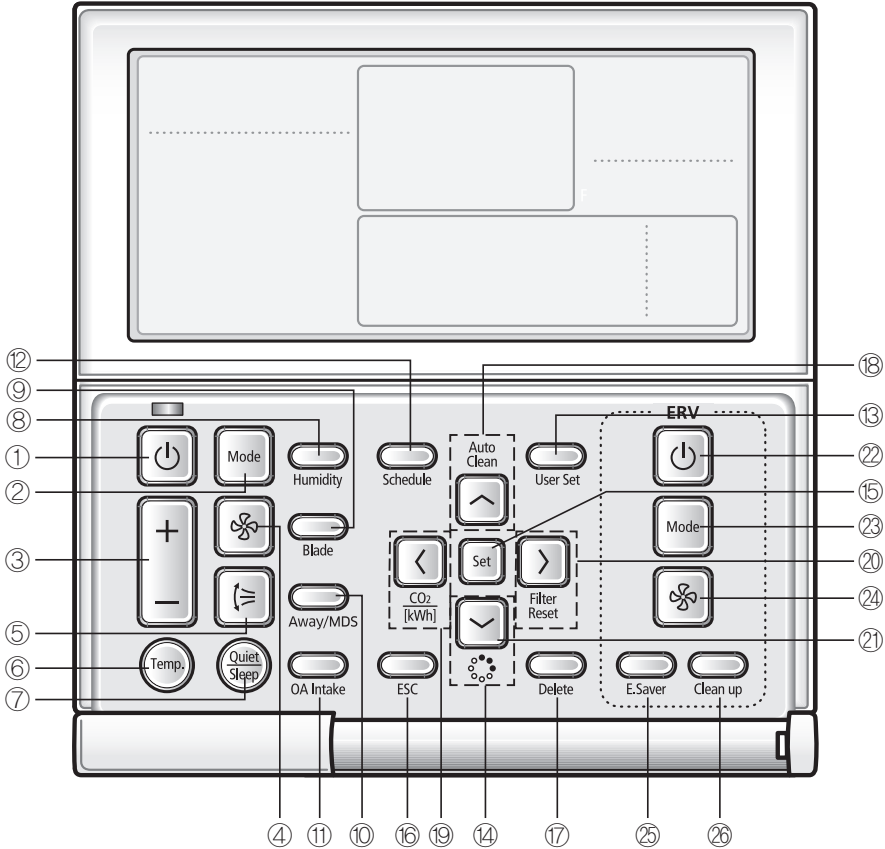











Classification	Indication	Function
Air Conditioner Related Information	① Auto Cool Dry Fan Heat Defrost	Displays Air conditioner operation
	② Quiet Sleep	Displays Quiet/Sleep operation
	③ Temp. Set Temp. 88.8 °C°F	Displays Indoor temperature/Set temperature
	④	Displays discharge temperature control
	⑤ 88.8 CO ₂ (kg) [kWh]	Displays CO ₂ /power consumption
	⑥ AC Fan Speed	Displays AC fan speed
	⑦ Blade 1 2 3 4	Displays Blade selection
	⑧ Swing Up/Dn	Displays Air swing(Up/Dn)
Schedule related information	⑨ Timer Weekly Holiday	Weekly schedule/Holiday setting displays
	⑩ S M T W T F S	Displays Current day(□) or scheduled day(□)
	⑪ 1 2 3 4 5 6	Displays Schedule number
	⑫ AC ERV	Displays Scheduled device selection
	⑬ AM 88:88 On Time PM 88:88 Off	Displays Current time/summer time/scheduled time
Ventilator (ERV) related information	⑭ Heat-EX Quiet Away By-Pass Auto Purifier	Displays Ventilator(ERV) operation
	⑮ Clean up	Displays Clean up
	⑯ ERV Fan Speed	Displays Ventilator(ERV) fan speed
Common function related information	⑰ Restricted Filter	Displays Invalid operation /Filter cleaning (filter cleaning period)
	⑱	Displays Dust box cleaning alert/check/partial locking/full locking
	⑲	Displays Away/Motion detect sensor/Range hood/External interconnection control/Auto clean/ Humidifying/Energy saving/ Outdoor air supply intake/ Central control
	⑳ S-Plasma Ion	Displays S-Plasma Ion
	㉑ CO ₂ ●●●●	Displays Indoor CO ₂ density
	㉒ Humidity ●●●●	Displays Indoor humidity
	㉓ 88	Displays remaining time of the auto stop time/ERV delay time - Solid : Hour unit, Blinking : Minute unit

Wire Remote Controller (Optional)

Buttons



Classification	Button	Function	
Air Conditioner Related Information	①	Operation On/Off button	Turns the air conditioner power On/Off
	②	Mode button	Selects the desired air conditioner operation
	③	Temperature setting button	Sets the desired temperature
	④	Fan speed button	Changes the air conditioner's fan speed
	⑤	Air Swing button	Changes the air flow direction to move upward or downward
	⑥	Temp. button	Checks the indoor temperature
	⑦	Quiet/Sleep button	Selects Quiet or Sleep operation for the air conditioner
	⑧	Humidity button	Turns the MINI AHU indoor unit humidifying function On/Off

Classification	Button	Function	
Air Conditioner Related Information	⑨  Blade	Blade button	Selects a blade for individual control
	⑩  Away/MDS	Away / Motion detect sensor button	Selects when no one is detected in an indoor area, when the air conditioner needs to be turned off automatically, when the AWAY operation is set
	⑪  OA Intake	Outdoor air intake	Select the MINI AHU indoor unit Outdoor intake function
Special Function Displays	⑫  Schedule	Schedule Button	Select the schedule setting function
	⑬  User Set	User Set Button	Select the detailed setting function
	⑭  Navigational buttons	Navigational buttons	Move between items or change the item value
	⑮  Set	Set button	Save your new settings
	⑯  ESC	ESC button	Return to general mode from schedule and detailed setting screens
	⑰  Delete	Delete button	Cancel the schedule setting
	⑱  Auto Clean	Auto Clean button	Use the auto cleaning function for your air conditioner
	⑲  CO ₂ /[kWh]	CO ₂ /[kWh] button	Display the amount of CO ₂ and the power consumption
	⑳  Filter Reset	Filter Reset button	Turn off the filter cleaning displays (filter using time reset)
	㉑  S-Plasma Ion	S-Plasma Ion button	Choose the S-Plasma Ion function
	Ventilator (ERV) Related Buttons	㉒  Power	Operation On/Off button
㉓  Mode		Mode button	Select the desired operation for the Ventilator(ERV)
㉔  Fan speed		Fan speed button	Change the fan speed for your Ventilator(ERV)
㉕  E.Saver		E.Saver button	Begin Energy Saving Operation
㉖  Clean up		Clean up button	Select air purification through the in/out load controls



NOTE

- After cleaning the filter, please press the **Filter Reset** button. The **Filter** lamp will turn off, and it will be turned on again upon the next cleaning period.
- If you press a functional button not supported by the indoor unit, then the **Restricted** lamp will turn on.
- If the temperature display setting is set to indoor temperature and you press the **Temp.** button, the **Restricted** lamp display will appear. (When you install the Wired Remote Controller, the setting is available.)
- If you press the **On/Off** button when your Ventilator(ERV) is connected to a Wired Remote Controller, then the air conditioner and the Ventilator(ERV) might operate or stop at the same time or only the air conditioner might operate or stop. The factory setting is set to simultaneous operation/stop. (When you install the Wired Remote Controller, the setting is available.)
- Although the air conditioner and the Ventilator(ERV) are set to simultaneous operation/stop, you can individually control the air conditioner and the Ventilator(ERV) by using another controller (e.g. wireless remote controller, central controller, S-net mini) except for a Wired Remote Controller.

Appendix

Troubleshooting

Refer to the following chart if the air conditioner operates abnormally. This may save time and unnecessary expenses.

PROBLEM	SOLUTION
The air conditioner does not operate immediately after it has been restarted.	<ul style="list-style-type: none">• Because of a protective mechanism, the appliance may not start operating immediately to keep the unit from overloading. The air conditioner will start in 3 minutes.
The air conditioner does not work at all.	<ul style="list-style-type: none">• Check that the power plug is properly connected. Insert the power plug into the wall socket correctly.• Check if the circuit breaker is switched on.• Check if there is a power failure.• Check your fuse. Make sure it is not blown out.
Timer function does not set.	<ul style="list-style-type: none">• Check if you press the ON/OFF button on the remote control after you have set the time.
Odors permeate in the room during operation.	<ul style="list-style-type: none">• Check if the appliance is running in a smoky area or if there is a smell entering from outside. Operate the air conditioner in Fan mode or open the windows to air out the room.
The air conditioner makes a bubbling sound.	<ul style="list-style-type: none">• A bubbling sound may be heard when the refrigerant is circulating through the compressor. Let the air conditioner operate in a selected mode.• When you press the  (ON/OFF) button on the remote control, noise may be heard from the drain pump inside the air conditioner.

PROBLEM	SOLUTION
The air conditioner does not turn on or off with the wired remote control.	<ul style="list-style-type: none"> Check if you set the wired remote control for group control. If the wired remote controller is used for group control, air conditioners connected to that wired remote controller will turn on or off in sequence and it may take some time (Maximum 32 seconds).
The wired remote control does not operate.	<ul style="list-style-type: none"> Check if TEST indicator is displayed on the wired remote control. If so, turn off the unit and switch off the circuit breaker. Call your nearest service center.

Operation ranges

The table below indicates the temperature and humidity ranges the air conditioner can be operated within. Refer to the table for efficient use.

MODE	OPERATIONAL TEMPERATURE	INDOOR HUMIDITY	IF OUT OF CONDITIONS
COOLING	20 °C to 52 °C	80 % or less	Condensation may occur on the indoor unit with risk to have either water blow off or drops on the floor.
HEATING	-5 °C to 15 °C	-	Internal protection triggers and the air conditioner will stop.
VENTILATING	5 °C to 52 °C	-	-

* Protective operation may start when the temperature is over 48 °C.

* Heating or fan operation will be stopped when the temperature is lower than -5 °C.

A fresh duct controls discharge temperature.

Depending on indoor/outdoor temperature or installation condition, actual discharge temperature may not be exactly controlled.

Model specification (weight and dimension)

Type	Model	Net weight	Net dimension (W x D x H)
Indoor unit	AM140MNEPEH/EU	49.0 kg	1210 x 656 x 370 mm
	AM220MNEPEH/EU	81.5 kg	1360 x 910 x 460 mm
	AM280MNEPEH/EU	81.5 kg	1360 x 910 x 460 mm

Indoor Unit Installation



CAUTION

- Indoor Unit Lifting
 - 1) Please use such tools as the pulley to lift the indoor unit to the draw bolts.
 - 2) Please use such tools as the level gauge to adjust the indoor unit to the level, otherwise, water leak may occur.
- Piping
- When the pipe goes through the wall, wall bushing should be used to prevent the insulation from being damaged by the wall which may result in poor insulation and condensate water.

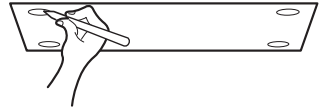

It is recommended to install the Y-joint before installing the indoor unit.

1. Place the pattern sheet on the ceiling where you want to install the indoor unit.



NOTE

- Since the diagram is made of paper, it may shrink or stretch slightly due to temperature or humidity. For this reason, maintain the correct measurements between the markings before drilling the holes.
- Pattern sheet is supplied depending on the model type.

2. Insert bolt anchors, use existing ceiling support or construct a suitable support as shown in the figure.
3. Install the suspension bolts depending on the ceiling type.

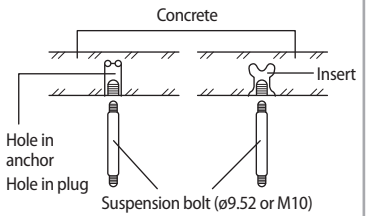

CAUTION

- Ensure that the ceiling is strong enough to support the weight of the indoor unit. Before hanging the unit, test the strength of each attached suspension bolt.
- If the suspension bolt length is more than 1.5m, it is required to deploy vibration prevention measures.
- If this is not possible, create an opening on the false ceiling in order to be able to use it to perform the required operations on the indoor unit.

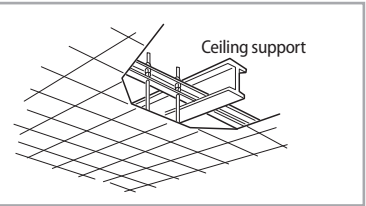

4. Screw eight nuts to the suspension bolts and make space for hanging the indoor unit.



CAUTION

- You must install more than 4 suspension bolts when installing the indoor unit.

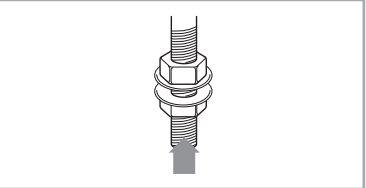

5. Hang the indoor unit to the suspension bolts between two nuts.



NOTE

- Piping must be laid and connected inside the ceiling when installing the indoor unit. If the ceiling is already constructed, lay the piping into the position for connection to the unit before placing the unit inside the ceiling.

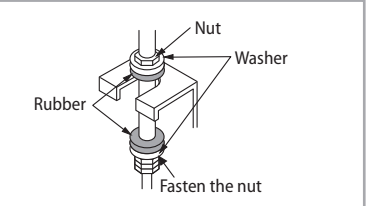

6. Screw the nuts to suspend the indoor unit.
7. Adjust the level of the unit by using measurement plate for all 4 sides.



NOTE

- For proper drainage of condensate, give a 'A' slant to the left or right side of the unit which will be connected with the drain hose, as shown in the figure. Make a tilt when you wish to install the drain pump, too.

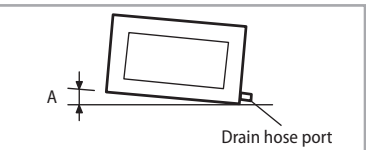

Unit	A
AM140MNEPEH***	10mm
AM220MNEPEH***	3mm
AM280MNEPEH***	

Performing Leak Test & Insulation

Leak test

LEAK TEST WITH NITROGEN(before opening valves)

In order to detect basic refrigerant leaks, before recreating the vacuum and recirculating the R-410A, it's responsible of installer to pressurize the whole system with nitrogen(using a pressure regulator) at a pressure above 4.1MPa(gauge).

LEAK TEST WITH R-410A(after opening valves)

Before opening valves, discharge all the nitrogen into the system and create vacuum. After opening valves check leaks using a leak detector for refrigerant R-410A.



- Discharge all the nitrogen to create a vacuum and charge the system.

AM140***

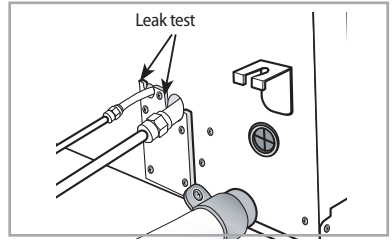

AM220/280***

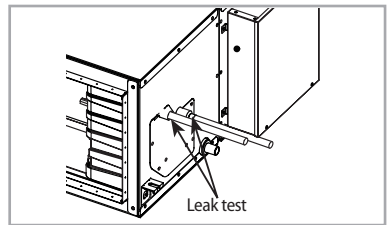

Insulation

Once you have checked that there are no leaks in the system, you can insulate the piping and hose.

1. To avoid condensation problems, place **T13.0 or thicker Acrylonitrile Butadien Rubber** separately around each refrigerant pipe.



- Always make the seam of pipes face upwards.

2. Wind insulating tape around the pipes and drain hose avoiding to compress the insulation too much.
3. Finish wrapping insulating tape around the rest of the pipes leading to the outdoor unit.
4. The pipes and electrical cables connecting the indoor unit with the outdoor unit must be fixed to the wall with suitable ducts.



- All refrigerant connection must be accessible, in order to permit either unit maintenance or removing it completely.

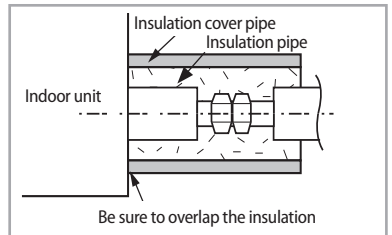
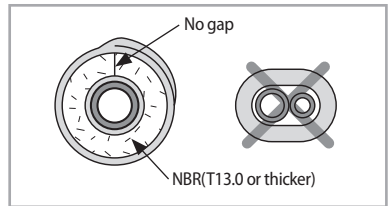

- Must fit tightly against body without any gap.

Performing Leak Test & Insulation

5. Select the insulation of the refrigerant pipe.
 - ▶ Insulate the gas side and liquid side pipe referring to the thickness according to the pipe size.
 - ▶ Indoor temperature of 30°C and humidity of 85% is the standard condition. If install in a high humidity condition, use one grade thicker insulator by referring to the table below. If installing in an unfavorable conditions, use thicker one.
 - ▶ Insulator's heat-resistance temperature should be more than 120°C.

Pipe	Pipe size	Installation type (Heating/Cooling)		Remarks
		Standard [30°C,85%]	High humidity [30°C, over 85%]	
		EPDM, NBR		
Liquid pipe	Ø6.35 ~ Ø9.52	9t	←	Internal temperature is higher than 120°C
	Ø12.7 ~ Ø50.80	13t	←	
Gas pipe	Ø6.35	13t	19t	
	Ø9.52	19t	25t	
	Ø12.70			
	Ø15.88			
	Ø19.05			
	Ø22.23			
	Ø25.40			
	Ø28.58	32t		
	Ø31.75			
	Ø38.10			
Ø44.45				
Ø50.80	25t	38t		



- Install the insulation not to get wider and use the adhesives on the connection part of it to prevent moisture from entering.
- Wind the refrigerant pipe with insulation tape if it is exposed to outside sunlight.
- Install the refrigerant pipe respecting that the insulation does not get thinner on the bent part or hanger of pipe.
- Add the additional insulation if the insulation plate gets thinner.

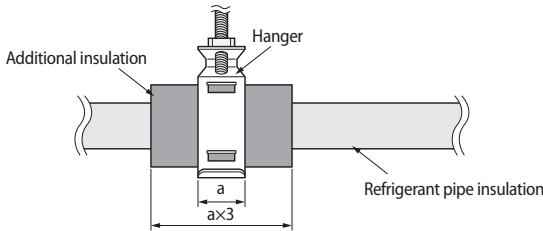

Drain pipe and Drain Hose Installation

Care must be taken when installing the drain hose for the indoor unit to ensure that any condensation is correctly drained outside. The drain hose can be installed to the left or right side of the base pan.

1. Install the drain hose as short as possible.
 - In order to discharge condensation water, the drain hose should keep tilted.
 - Secure the drain hose with the cable-tie not to be separated from the unit.
 - The drain pump connection port is used when using a drain pump.
 - Both ends of the drain hose must be fixed by PVC adhesive, to prevent leakage.
2. When there is no draining pump, insulate the drain hose and then fix it as a picture.
 - Insert the drain hose to bottom of the outfall of water basin.
 - Lock steel ring of the drain hose according to the figure.
 - Wind and wrap steel ring and drain hose fully with thermal insulation sponge; fix both ends of external layer with ribbon for thermal insulation.
 - After being installed, drain hose must be insulated fully by heat insulating material.(To be provided at site.)

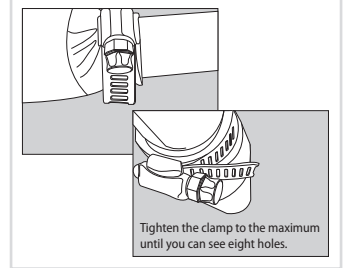
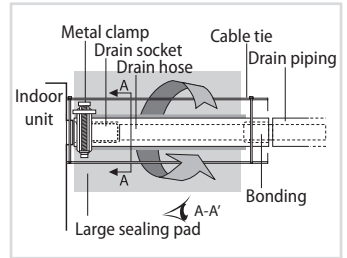

Drain pipe and Drain Hose Installation

Drainpipe connection

Without the drain pump

1. Install horizontal drain pipe with a slope of 1/100 or more and fix it by hanger space of 1.0~1.5m.
2. Install U-trap at the end of the drainpipe to prevent odors reaching the indoor unit.
3. Do not install the drainpipe to upward position. It may cause water flow back to the unit.

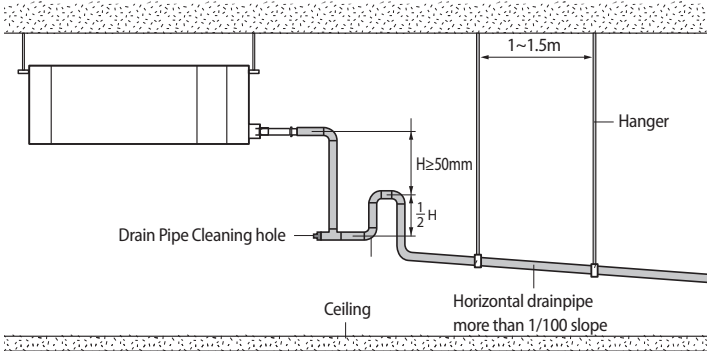

With the drain pump

1. The drain pipe should be installed within 300mm to 550mm from the flexible hose and then lift down 20mm or more.
2. Install horizontal drain pipe with a slope of 1/100 or more and fix it by hanger space of 1.0~1.5m.
3. Install the air vent in the horizontal drainpipe to prevent water flow back to the indoor unit.



- You may not need to install it if there were proper slope in the horizontal drainpipe.

4. The flexible hose should not be installed upward position, it may cause water flow back to the indoor unit.

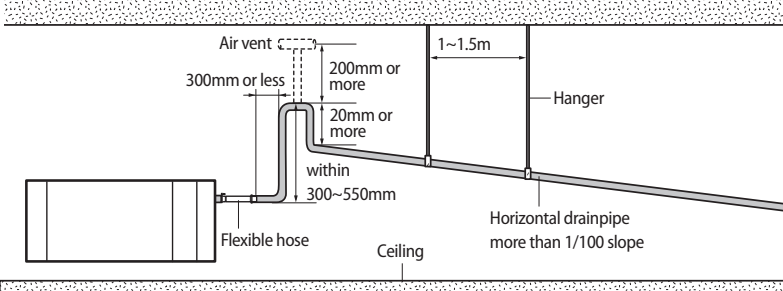

Centralized drainage

Without the drain pump

1. Install horizontal drainpipe with a slope of 1/100 or more and fix it by hanger space of 1.0~1.5m.
2. Install U-trap at the end of the drainpipe to prevent odors reaching the indoor unit.
3. The drain pipe should not be installed at an upward position; it may cause water flowing back to the unit.

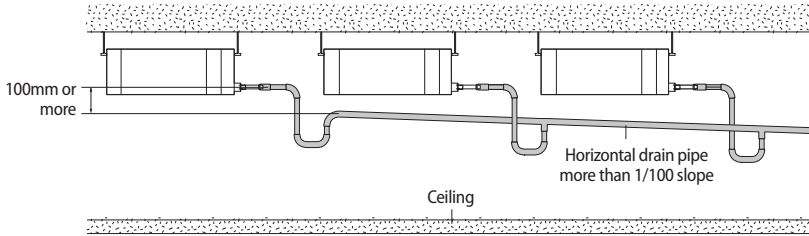

With the drain pump

1. Install main air vent at the front of the farthest indoor unit from the main drain when installed indoor units are more than 3.
2. You may need to install individual air vent to prevent water flow back at the top of each indoor unit drainpipe.

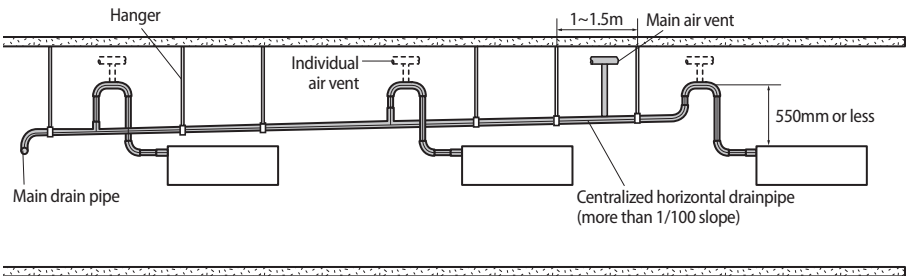

Wiring Work

Power and communication cable connection

1. Before wiring work, you must turn off all power source.
2. Indoor unit power should be supplied through the breaker (MCCB: Molded Case Circuit Breaker, ELB: Earth Leakage Breaker, ELCB: Earth Leakage Circuit Breaker) separated by the outdoor power.
MCCB: overcurrent protection
ELB: earth leakage protection
ELCB: overcurrent protection + earth leakage protection
3. The power cable should only use copper wires.
4. Connect the power cable {1(L), 2(N)} among the units and communication cables (F1, F2). The maximum length of cables shall be 1000m.
5. When installing the wired remote control, connect F3 and F4 (for communication).
(Indoor PBA will be damaged if V1, V2, F3, F4 are shorted out.)
6. Installation conditions for a wired remote controller
 - ▶ A fresh duct and an indoor unit should not be installed by one wired remote controller.
 - ▶ The fresh duct has a different operation mode, temperature setting, etc. Therefore, if fresh ducts and indoor units, they should not share a wired remote controller. Make sure to install wired remote controller separately for fresh ducts and indoor units.
 - ▶ Installation between fresh ducts can be controlled by one wired remote controller.

Example of correct installation

Installation between fresh ducts

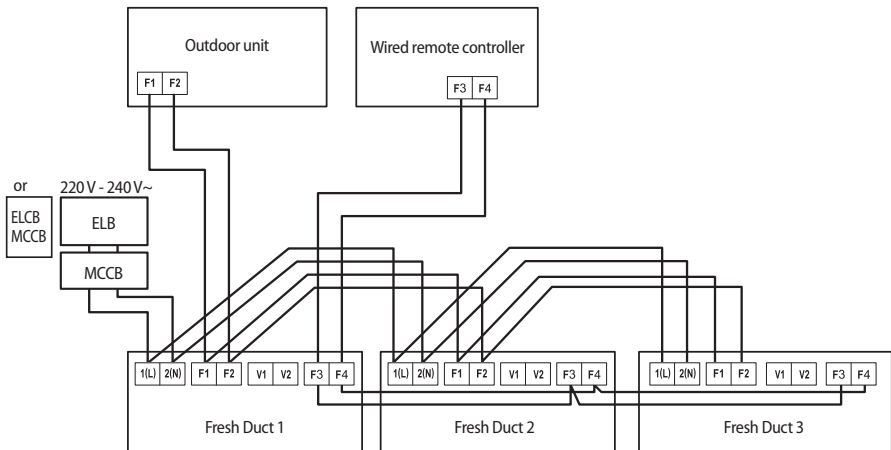

* ELCB : Essential installation.



• Power off before connecting any wire. Indoor PBA will be damaged if V1, V2, F3, F4 are shorted out.



• Installation between fresh ducts can be controlled by one wired remote controller.

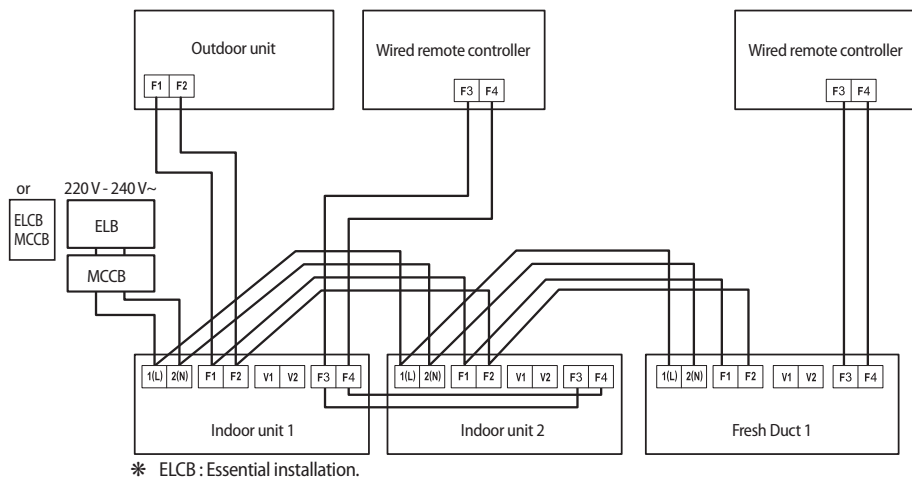

WARNING

- Power off before connecting any wire. Indoor PBA will be damaged if V1, V2, F3, F4 are shorted out.



NOTE

- If indoor units are mixed with fresh ducts, they should not be controlled by one wired remote controller.

Example of incorrect installation

Installation between a fresh duct and an indoor unit

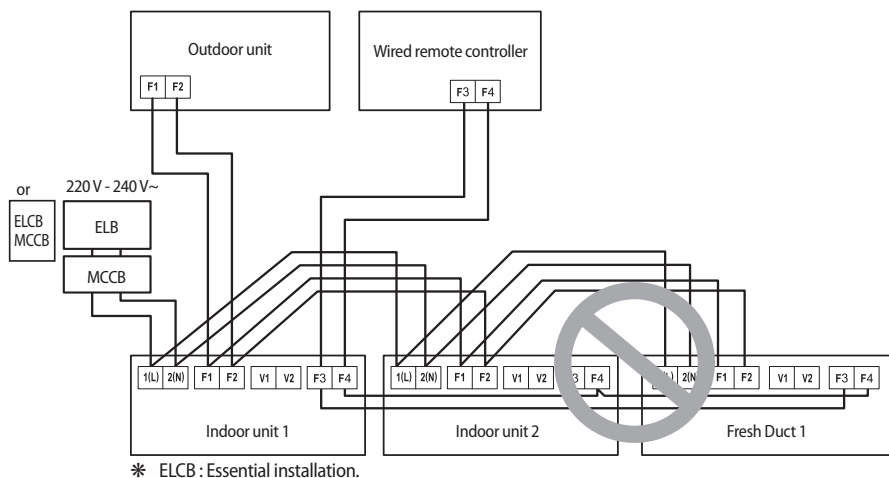

WARNING

- Power off before connecting any wire. Indoor PBA will be damaged if V1, V2, F3, F4 are shorted out.



NOTE

- If indoor units mixed with fresh ducts are controlled by one wired remote controller, a problem may occur due to different operation specification.

Wiring Work

Selecting compressed ring terminal

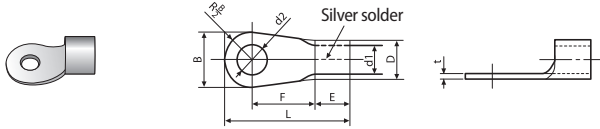

Nominal dimensions for cable (mm ²)		1.5		2.5		4	
Nominal dimensions for screw (mm)		4		4		4	
B	Standard dimension (mm)	6.6	8	6.6	8.5	9.5	
	Allowance (mm)	±0.2		±0.2		±0.2	
D	Standard dimension (mm)	3.4		4.2		5.6	
	Allowance (mm)	+0.3	-0.2	+0.3	-0.2	+0.3	
d1	Standard dimension (mm)	1.7		2.3		3.4	
	Allowance (mm)	±0.2		±0.2		±0.2	
E	Min.	4.1		6		6	
F	Min.	6		6		5	
L	Max.	16		17.5		20	
d2	Standard dimension (mm)	4.3		4.3		4.3	
	Allowance (mm)	+0.2	0	+0.2	0	+0.2	
t	Min.	0.7		0.8		0.9	

Specification of electric wire

Power supply	MCCB	ELB or ELCB	Power cable	Earth cable	Communication cable
Max.: 242V Min.: 198V	XA	XA, 30mmA 0.1 s	2.5mm ²	2.5mm ²	0.75~1.5mm ²

- ▶ Decide the capacity of ELCB(or MCCB+ELB) by below formula.
- ▶ Power supply cords of parts of appliances for outdoor use shall not be lighter than polychloroprene sheathed flexible cord. (Code designation IEC:60245 IEC 57 / CENELEC: H05RN-F or IEC:60245 IEC 66 / CENELEC: H07RN-F)

$$\text{The capacity of ELCB or MCCB and ELB } X[A] = 1.25 \times 1.1 \times \sum A_i$$

- * X: The capacity of ELCB or MCCB and ELB
- * $\sum A_i$: Sum of rating currents of each indoor unit.
- * Refer to each installation manual about the rating current of indoor unit.
- ▶ Decide the power cable specification and maximum length within 10% power drop among the indoor units.

$$\sum_{k=1}^n \left(\frac{\text{Coef} \times 35.6 \times L_k \times i_k}{1000 \times A_k} \right) < 10\% \text{ of input voltage [V]}$$

- * coef: 1.55
- * L_k : Distance among each unit [m], A_k : Power cable specification [mm²]
- * i_k : Running current of each unit [A]

- * Run transmission wiring between the indoor and outdoor units through a conduit to protect against external forces, and feed the conduit through the wall together with refrigerant piping.

Setting an indoor unit address and installation option

Set the indoor unit address and installation option with remote controller option.

Set the each option separately since you cannot set the ADDRESS setting and indoor unit installation setting option at the same time. You need to set twice when setting indoor unit address and installation option.

The procedure of option setting

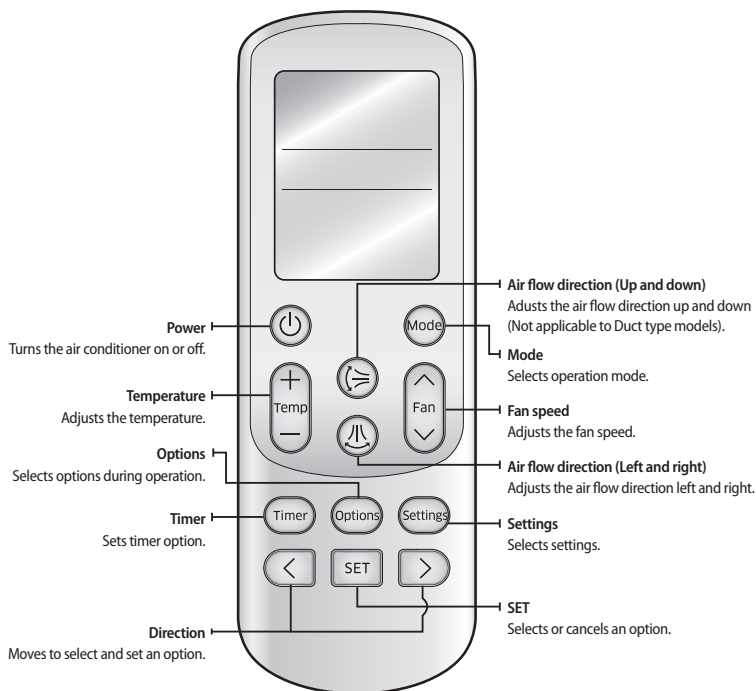

Step 1. Entering mode to set option

1. Remove batteries from the remote controller.
2. Insert batteries and enter the option setting mode while pressing High Temp button and Low Temp button.
3. Check if you have entered the option setting status.



Step 2. The procedure of option setting

After entering the option setting status, select the option as listed below.

































































Option setting is available from SEG1 to SEG24

- SEG1, SEG7, SEG13, SEG19 are not set as page option.
- Set the SEG2~SEG6, SEG8~SEG12 as ON status and SEG14~18, SEG20~24 as OFF status.

SEG1	SEG2	SEG3	SEG4	SEG5	SEG6	SEG7	SEG8	SEG9	SEG10	SEG11	SEG12	On(SEG1~12)	Off(SEG13~24)
0	X	X	X	X	X	1	X	X	X	X	X		
SEG13	SEG14	SEG15	SEG16	SEG17	SEG18	SEG19	SEG20	SEG21	SEG22	SEG23	SEG24		
2	X	X	X	X	X	3	X	X	X	X	X		

Setting an indoor unit address and installation option

Option setting	Status
<p>1. Setting SEG2, SEG3 option</p> <p>Press Low Fan button(V) to enter SEG2 value.</p> <p>Press High Fan button(Λ) to enter SEG3 value.</p> <p>Each time you press the button,  →  → ...  →  will be selected in rotation.</p>	  SEG2 SEG3
<p>2. Setting Cool mode</p> <p> Press Mode button to be changed to Cool mode in the ON status.</p>	
<p>3. Setting SEG4, SEG5 option</p> <p>Press Low Fan button(V) to enter SEG4 value.</p> <p>Press High Fan button(Λ) to enter SEG5 value.</p> <p>Each time you press the button,  →  → ...  →  will be selected in rotation.</p>	  SEG4 SEG5
<p>4. Setting Dry mode</p> <p> Press Mode button to be changed to DRY mode in the ON status.</p>	
<p>5. Setting SEG6, SEG8 option</p> <p>Press Low Fan button(V) to enter SEG6 value.</p> <p>Press High Fan button(Λ) to enter SEG8 value.</p> <p>Each time you press the button,  →  → ...  →  will be selected in rotation.</p>	  SEG6 SEG8
<p>6. Setting Fan mode</p> <p> Press Mode button to be changed to FAN mode in the ON status.</p>	
<p>7. Setting SEG9, SEG10 option</p> <p>Press Low Fan button(V) to enter SEG9 value.</p> <p>Press High Fan button(Λ) to enter SEG10 value.</p> <p>Each time you press the button,  →  → ...  →  will be selected in rotation.</p>	  SEG9 SEG10
<p>8. Setting Heat mode</p> <p> Press Mode button to be changed to HEAT mode in the ON status.</p>	
<p>9. Setting SEG11, SEG12 option</p> <p>Press Low Fan button(V) to enter SEG11 value.</p> <p>Press High Fan button(Λ) to enter SEG12 value.</p> <p>Each time you press the button,  →  → ...  →  will be selected in rotation.</p>	  SEG11 SEG12
<p>10. Setting Auto mode</p> <p> Press Mode button to be changed to AUTO mode in the OFF status.</p>	
<p>11. Setting SEG14, SEG15 option</p> <p>Press Low Fan button(V) to enter SEG14 value.</p> <p>Press High Fan button(Λ) to enter SEG15 value.</p> <p>Each time you press the button,  →  → ...  →  will be selected in rotation.</p>	  SEG14 SEG15
<p>12. Setting Cool mode</p> <p> Press Mode button to be change to Cool mode in the OFF status.</p>	

Option setting	Status
<p>13. Setting SEG16, SEG17 option</p> <p>Press Low Fan button(V) to enter SEG16 value.</p> <p>Press High Fan button(^) to enter SEG17 value.</p> <p>Each time you press the button, → → ... → will be selected in rotation.</p>	  SEG16 SEG17
<p>14. Setting Dry mode</p> <p> Press Mode button to be change to Dry mode in the OFF status.</p>	
<p>15. Setting SEG18, SEG20 option</p> <p>Press Low Fan button(V) to enter SEG18 value.</p> <p>Press High Fan button(^) to enter SEG20 value.</p> <p>Each time you press the button, → → ... → will be selected in rotation.</p>	  SEG18 SEG20
<p>16. Setting Fan mode</p> <p> Press Mode button to be change to Fan mode in the OFF status.</p>	
<p>17. Setting SEG21, SEG22 option</p> <p>Press Low Fan button(V) to enter SEG21 value.</p> <p>Press High Fan button(^) to enter SEG22 value.</p> <p>Each time you press the button, → → ... → will be selected in rotation.</p>	  SEG21 SEG22
<p>18. Setting Heat mode</p> <p> Press Mode button to be change to HEAT mode in the OFF status.</p>	
<p>19. Setting SEG23, SEG24 mode</p> <p>Press Low Fan button(V) to enter SEG23 value.</p> <p>Press High Fan button(^) to enter SEG24 value.</p> <p>Each time you press the button, → → ... → will be selected in rotation.</p>	  SEG23 SEG24

Step 3. Check the option you have set

After setting option, press  button to check whether the option code you input is correct or not.

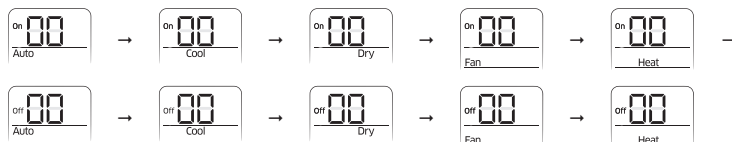

Step 4. Input option

Press operation button  with the direction of remote control for set.

For the correct option setting, you must input the option twice.

Step 5. Check operation

1. Reset the indoor unit by pressing the RESET button of indoor unit or outdoor unit.
2. Take the batteries out of the remote controller and insert them again and then press the operation button.

Setting an indoor unit address and installation option

Setting an indoor unit address (MAIN/RMC)

1. Check whether power is supplied or not.
 - ▶ When the indoor unit is not plugged in, there should be additional power supply in the indoor unit.
2. The panel(display) should be connected to an indoor unit to receive option.
3. Before installing the indoor unit, assign an address to the indoor unit according to the air conditioning system plan.
4. Assign an indoor unit address by wireless remote controller.
 - ▶ The initial setting status of indoor unit ADDRESS(MAIN/RMC) is "0A0000-100000-200000-300000".

Option No. : 0AXXXX-1XXXXX-2XXXXX-3XXXXX

Option	SEG1		SEG2		SEG3		SEG4		SEG5		SEG6	
Explanation	PAGE		MODE		Setting Main address		100-digit of indoor unit address		10-digit of indoor unit		The unit digit of an indoor unit	
Indication and Details	Indication	Details	Indication	Details	Indication	Details	Indication	Details	Indication	Details	Indication	Details
		0		A		0	No Main address	0~9	100-digit	0~9	10-digit	0~9
					1	Main address setting mode						
Option	SEG7		SEG8		SEG9		SEG10		SEG11		SEG12	
Explanation	PAGE		-		Setting RMC address		-		Group channel(*16)		Group address	
Indication and Details	Indication	Details			Indication	Details			Indication	Details	Indication	Details
		1				0	No RMC address					
					1	RMC address setting mode			RMC1	0~F	RMC2	0~F



- When "A"~"F" is entered to SEG5~6, the indoor unit MAIN ADDRESS is not changed.
- If you set the SEG 3 as 0, the indoor unit will maintain the previous MAIN ADDRESS even if you input the option value of SEG5~6.
- If you set the SEG 9 as 0, the indoor unit will maintain previous RMC ADDRESS even if you input the option value of SEG11~12.
- You cannot set SEG11 and SEG12 as F value at the same time.

Setting an indoor unit installation option (suitable for the condition of each installation location)

1. Check whether power is supplied or not.
 - ▶ When the indoor unit is not plugged in, there should be additional power supply in the indoor unit.
2. The panel(display) should be connected to an indoor unit to receive option.
3. Set the installation option according to the installation condition of an air conditioner.
 - ▶ The default setting of an indoor unit installation option is "020010-100000- 200000-300000".
 - ▶ Individual control of a remote controller(SEG20) is the function that controls an indoor unit individually when there is more than one indoor unit.
4. Set the indoor unit option by wireless remote controller.

02 series installation option

SEG1	SEG2	SEG3	SEG4	SEG5	SEG6
0	2	-	-	Central control	-
SEG7	SEG8	SEG9	SEG10	SEG11	SEG12
1	Drain pump	-	-	EEV Step when heating stops	Master / Slave
SEG13	SEG14	SEG15	SEG16	SEG17	SEG18
2	External control	External control output	-	-	Number of hours using filter
SEG19	SEG20	SEG21	SEG22	SEG23	SEG24
3	-	Heating setting compensation	EEV Step of stopped unit during oil return/defrost mode	-	-

- ▶ 1 WAY / 2WAY / 4WAY, DUCT MODEL : Number of hours using filter(SEG18) will be set to '1000 hour' even if the SEG18 is set to except for 2 or 6.
- ▶ When setting the option other than above SEG values, the option will be set as "0".
- ▶ SEG5 central control option is basically set as 1 (Use), so you don't need to set the central control option additionally. However, if the central control is not connected but it doesn't indicate an error message, you need to set the central control option as 0 (Disuse) to exclude the indoor unit from the central control.

Setting an indoor unit address and installation option

O2 series installation option(Detailed)

Option No. : 02XXXX-1XXXX-2XXXX-3XXXX

Option	SEG1		SEG2		SEG3		SEG4		SEG5		SEG6	
Explanation	PAGE		MODE		-		-		Use of central control		-	
Indication and Details	Indication	Details	Indication	Details	Indication	Details	Indication	Details	Indication	Details	Indication	Details
	0		2		-	-	-	-	0	Disuse	-	-
									1	Use		
Option	SEG7		SEG8		SEG9		SEG10		SEG11		SEG12	
Explanation	PAGE		Use of drain pump		-		-		EEV Step when heating stops		Master / Slave	
Indication and Details	Indication	Details	Indication	Details	Indication	Details	Indication	Details	Indication	Details	Indication	Details
	1		0	Disuse					0	Default value	0	slave
			1	Use					1	Noise decreasing setting	1	master
			2	When an indoor unit stops, drain pump will operate for 3min.	-	-	-	-				
Option	SEG13		SEG14		SEG15		SEG16		SEG17		SEG18	
Explanation	PAGE		Use of external control		Setting the output of external control		-		-		Number of hours using filter	
Indication and Details	Indication	Details	Indication	Details	Indication	Details	Indication	Details	Indication	Details	Indication	Details
	2		0	Disuse	0	Thermo on					2	1000 Hour
			1	ON/OFF control	1	Operation on					6	2000 Hour
			2	OFF control								
3			Window ON/OFF control									
Option	SEG19		SEG20		SEG21		SEG22		SEG23		SEG24	
Explanation	PAGE		-		Heating setting compensation		EEV Step of stopped unit during oil return/defrost mode		-		-	
Indication and Details	Indication	Details	Indication	Details	Indication	Details	Indication	Details	Indication	Details	Indication	Details
	3				0	Disuse	0	Default value				
					1	2°C	1	Oil return or Noise decreasing in defrost mode				
2					5°C							

Changing a particular option

You can change each digit of set option.

Option	SEG1		SEG2		SEG3		SEG4		SEG5		SEG6	
Explanation	PAGE		MODE		-		-		-		-	
Indication and Details	Indication	Details	Indication	Details	Indication	Details	Indication	Details	Indication	Details	Indication	Details
	0		D		-	-	-	-	-	-	-	-



NOTE

- When changing a digit of an indoor unit address setting option, set the SEG3 as 'A'.
 - When changing a digit of indoor unit installation option, set the SEG3 as '2'.
- Ex) When setting the 'buzzer control' into disuse status.

Option	SEG1	SEG2	SEG3	SEG4	SEG5	SEG6
Explanation	PAGE	MODE	The option mode you want to change	The tens' digit of an option SEG you will change	The unit digit of an option SEG you will change	The changed value
Indication	0	D	2	1	7	1



CAUTION

- If you are using heat pump model, mixed operation mode (two or more indoor units operating in different operation mode simultaneously) is not available when the indoor units are connected to same outdoor unit. If you set the master indoor unit with a remote controller, outdoor unit will operate in the mode which was set in the master indoor unit.