



*spigo*acoustic®



TECHOS Y REVESTIMIENTOS: SPIGOACUSTIC  
CEILINGS AND WALL COVERINGS: SPIGOACUSTIC

# Spigo - acoustic

Spigoacoustic, división de Spigogroup especializada en paneles de madera fonoabsorbentes con estilo lineal diseñados para ofrecer un óptimo rendimiento acústico.

Spigoacoustic, division of Spigogroup is the system made up of linear sound-absorbent panels or acoustic panels designed to offer an optimum acoustic performance.

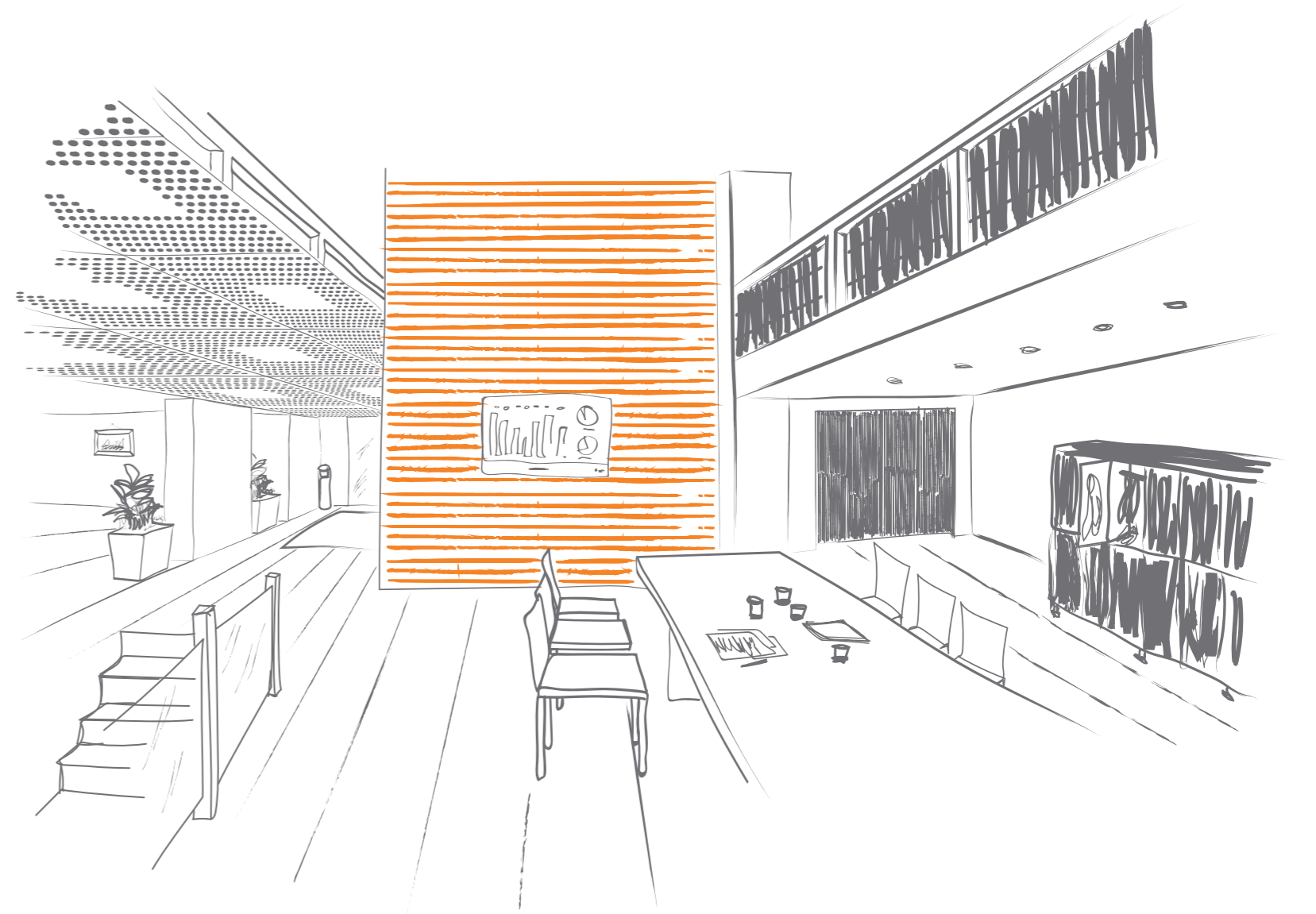



## Acabados

### Finishes

Spigoacustic le ofrece todo un mundo de posibilidades y contrastes en acabados y materiales. Cuidados al más mínimo detalle le garantiza la combinación que mejor se adapte a su proyecto, espacio y estilo deseado.

Spigoacustic offers a world of possibilities and contrasts in finishes and materials. Furthermore, Spigogroup takes care of the minimum detail and promise the best combination between project, space and desired style.

#### MELAMINA MELAMINE

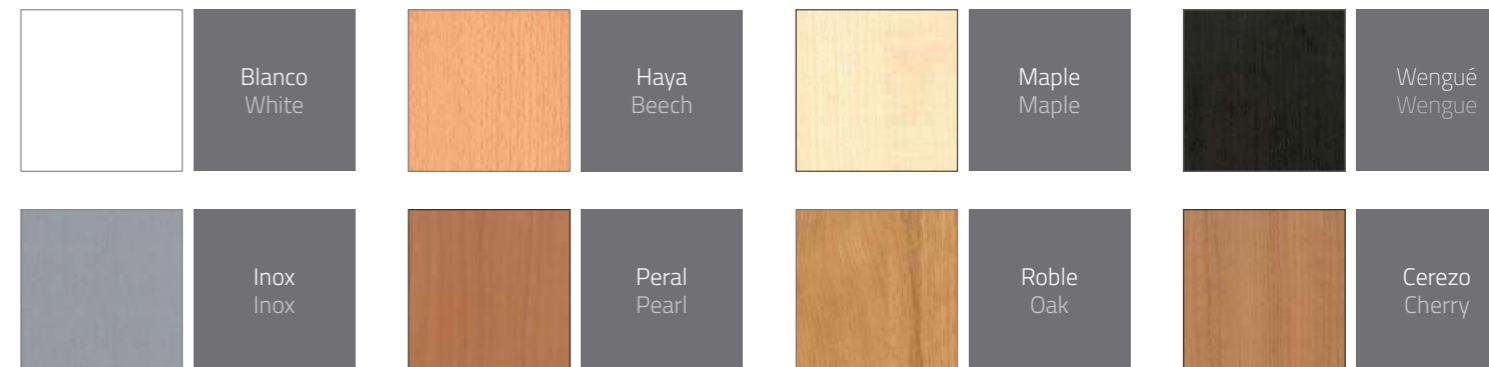

#### MADERA NATURAL BARNIZADA VARNISHED VENEER

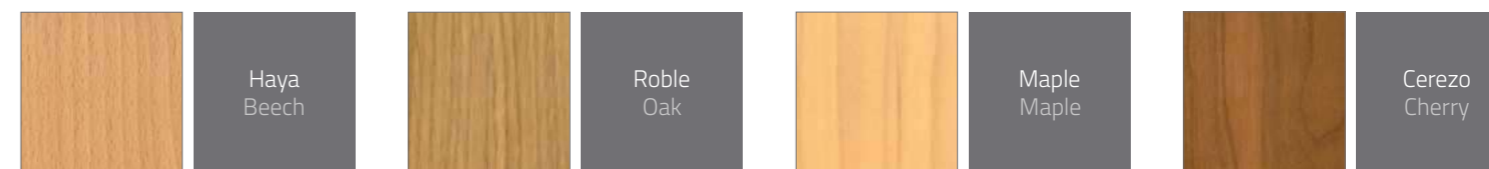

\* Otros acabados en madera natural, consultar.  
\* If others finishes are required, please consult us.

#### LACADO LACQUER

Capacidad de adaptar los paneles Spigoacustic a cualquier referencia de las cartas RAL, PANTONE o NCS.

Spigogroup has the capacity of adapting Spigoacustic panels to any reference of PANTONE, RAL o NCS cards.

#### APLACADO ALTA DENSIDAD HIGH-DENSITY CLADDING (HPL)

Aplacados de laminados de alta densidad (HPL) con altas prestaciones térmicas y resistentes.

High density laminated cladding (HPL) above chosen support.

\* Las muestras de colores impresas en este catálogo pueden presentar ligeras variaciones de color respecto a las terminaciones reales.  
\* The colour samples displayed in this catalogue can vary regarding the real endings.



## Soportes

## Supports

Spigoacoustic le garantiza la confianza de contar con diferentes opciones de soportes a elegir que mejoren las prestaciones deseadas en sus paneles de madera.

Spigoacoustic demonstrates the confidence to count on different choices of supports which improve the desired performances in their wood panels.



MDF  
Estándar  
Standard



MDF  
Ignífugo  
Fire-Retardant



MDF  
Hidrófugo  
Moisture  
resistant

La madera ocupa un lugar de honor entre los materiales cálidos que se usan para revestir techos y paredes. Su calidez como material lo convierte en óptimo para una infinidad de espacios y salas polivalentes.

Wood occupies a position of prestige among warm materials, which are used to cover ceilings and walls. Its warmth as a material makes it perfect for large spaces in which a high number of spaces and multipurpose rooms.

**+**  
*El soporte ignífugo puede presentar tonalidades rojizas en su aspecto. El soporte hidrófugo puede presentar tonalidades verdosas en su aspecto.*

*Fire-retardant support and moisture-resistant support can show red and green tonalities due to the components used to lend these characteristics to the supports.*

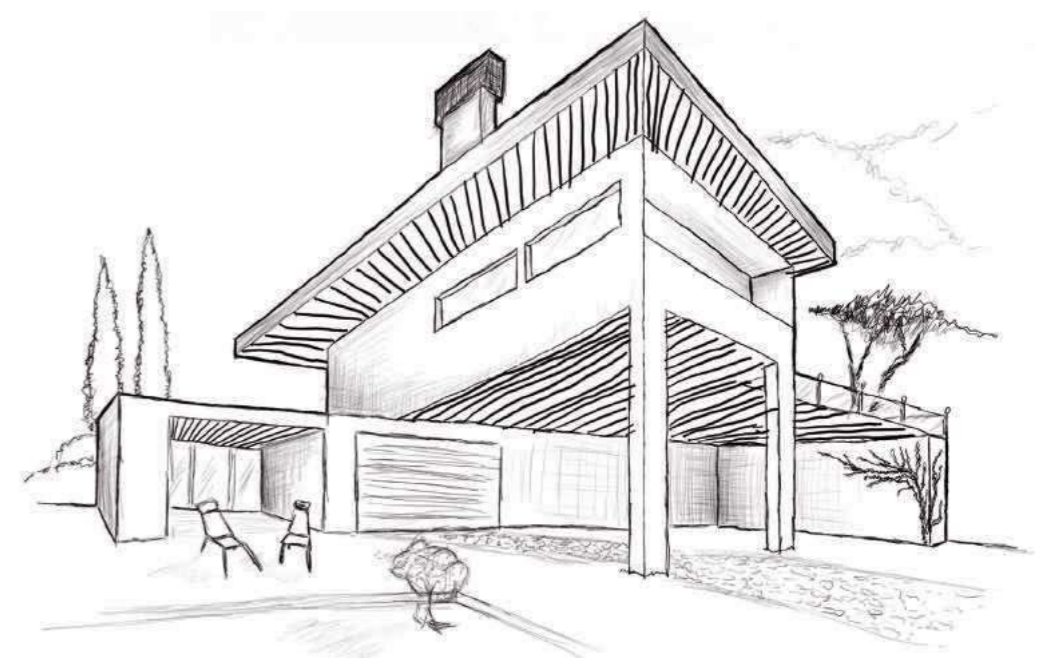



## Modelos

## Models

Spigoacoustic gracias a las diferentes combinaciones de canales en su cara vista y perforaciones circulares en su cara oculta, es capaz de ofrecer una amplia y variada gama de modelos de alta calidad.

Spigoacoustic thanks to the multiple possibilities in finishes and perforations, is capable of offering a wide variety of high quality range models.

## COMO INTERPRETAR LOS PANELES AS YOU HAVE TO INTERPRET THE PANELS

A la hora de la elección de sus paneles Spigoacoustic es importante entender bien la nomenclatura que usa Spigogroup para identificar cada modelo. Por ello, a través de la siguiente guía, tratamos de explicar fácilmente como interpretarlos.

When choosing Spigoacoustic panels, it is important to understand well the nomenclature which Spigogroup uses to identify each model. Therefore, through the following guide, Spigogroup tries to explain easily how to interpret them.

**+** EJEMPLO EXAMPLE

**42-32-16**  
A B C

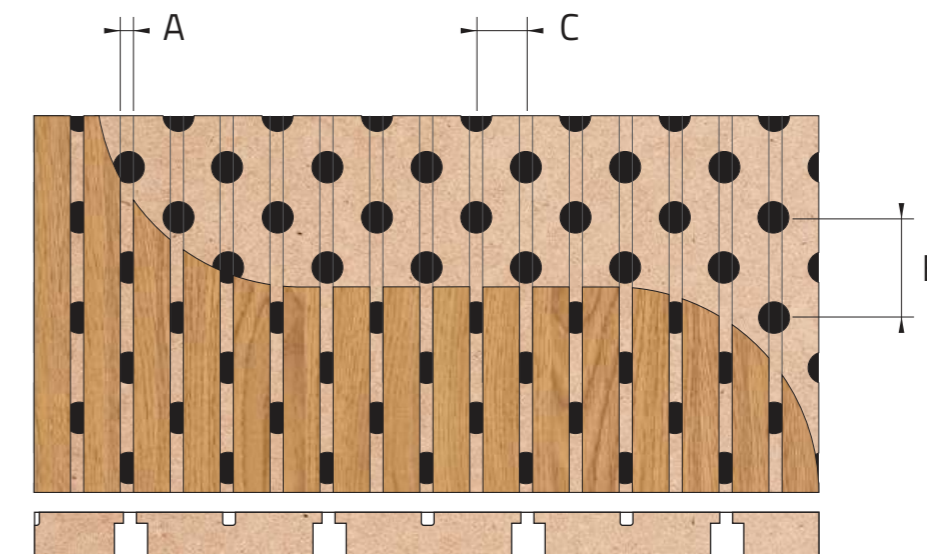

A	Ancho del canal Width channel	2,0   2,8   4,2 mm
B	Distancia entre taladros Distance between back holes	NO   16   32 mm
C	Distancia entre canales Distance between channels	8   16   32   64 mm

LISO PLAIN



Liso

MODELOS ANCHO CANAL 2 mm MODELS WITH 2 mm CHANNEL

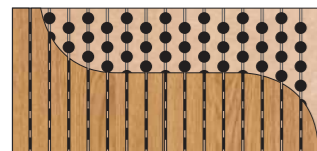

20-16-16

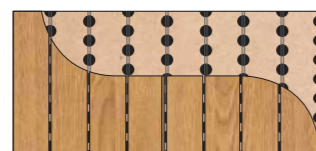

20-16-32



20-16-64

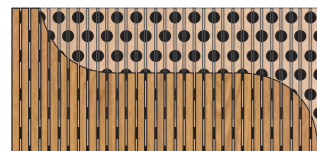

20-32-8



20-32-16



20-32-32

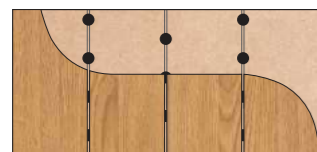

20-32-64

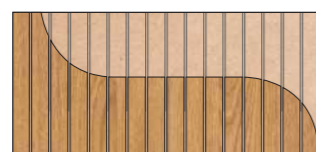

20-NO-16

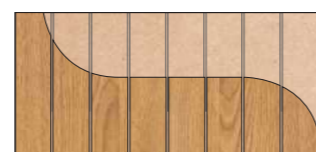

20-NO-32



20-NO-64

MODELOS ANCHO CANAL 2,8 mm MODELS WITH 2,8 mm CHANNEL

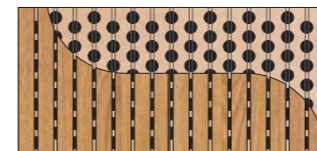

28-16-16

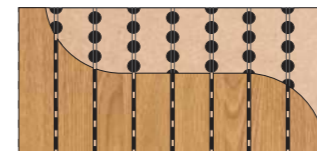

28-16-32

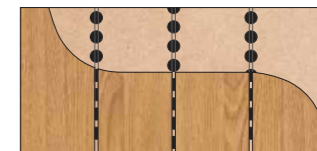

28-16-64



28-32-16

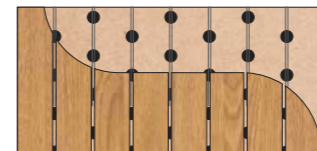

28-32-32

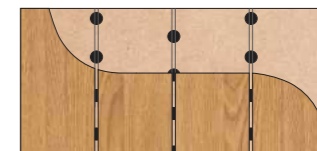

28-32-64



28-NO-16



28-NO-32



28-NO-64

MODELOS ANCHO CANAL 4,2 mm MODELS WITH 4,2 mm CHANNEL

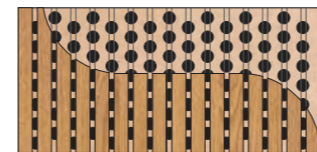

42-16-16

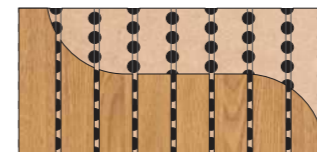

42-16-32

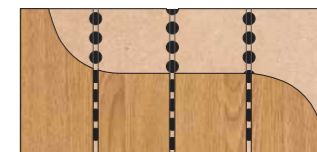

42-16-64

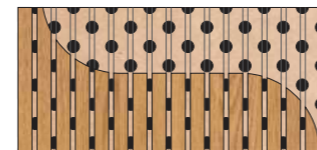

42-32-16

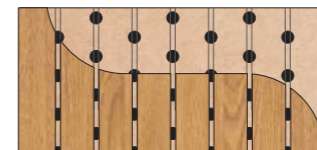

42-32-32

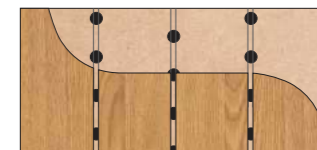

42-32-64



42-NO-16



42-NO-32

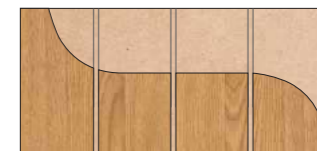

42-NO-64

\* Todos nuestros modelos pueden incorporar un velo acústico fono-absorbente de 0,25 mm termoaderido al dorso de la placa.  
 \* All our models have the possibility to incorporate a sound-absorbing black veil of 0,25 mm thermally attached to the back.



## Medidas

### Sizes

Spigoacoustic le ofrece unas medidas de placas estandarizadas pero es capaz de adaptarse a los entornos más exigentes fabricando paneles a medida y consiguiendo unos resultados de excelencia en cada detalle.

Spigoacoustic provides standardized sizes of planks but it is capable of adapting to the most demanding contexts, manufacturing custom-made panels and getting excellent results in each detail.

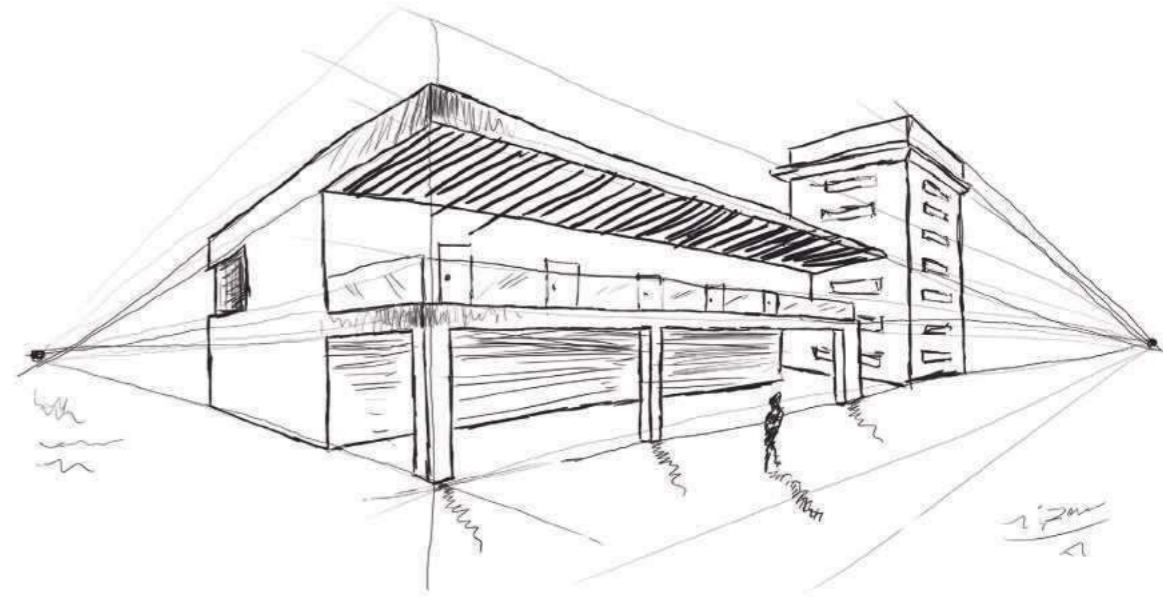

Las medidas de los paneles y de sus mecanizados perimetrales son estándar, de manera que no sólo facilitan el montaje de la instalación sino también la homogeneidad visual de la superficie resulta impecable.

The measurements of the panels and their profiles are standard. In this way, the installation and assembly are simple and the visual consistency of the surface is flawless.

#### MEDIDAS PANELES TECHOS CEILING SIZES

Perfil oculto T-15 (desmontable y registrable) Concealed Form T-15 (accessible)  
1200x300 mm.

Perfil semivisto T-15/T-24 (desmontable y registrable) Semi-exposed Form T-15/T24 (accessible)  
600x600 mm/1200x300/1200x600 mm

Perfil oculto T-24 + grapa (desmontable, no registrable) Concealed Form T-15 + fixing iron cramp (no accessible)  
1200x300/2400x300 mm.

#### MEDIDAS PANELES REVESTIMIENTOS PARED WALL SIZES

Machihembrado Male-female joint  
1200x300/2400 x 300 mm

#### OTRAS MEDIDAS ESPECIALES OTHER SPECIAL SIZES

Posibilidad de fabricar en cualquier medida según proyecto, consultar.  
There is the possibility to produce in any sizes depending on project, consult.



*Las medidas reales de cubrición podrán variar según el mecanizado perimetral de las placas y la periferia sobre la que se instale.*

*The real covering measurements can vary according to the perimeter machining of the panels and the structure onto which they are to be installed.*

[www.spigogroup.com](http://www.spigogroup.com)



# Instalación

## Installation

Spigoacustic le garantiza el mejor asesoramiento sobre la elección del sistema de instalación idóneo según las características de las placas y el diseño del proyecto planteado.

Spigoacustic advises on the choice of the best installation system according to the characteristics of panels and the design of proposed project.

### PERFIL OCULTO T-15 CONCEALED FORM T-15

El sistema de perfilera oculo T-15 a través de una "T" invertida simplifica la instalación de las placas con bordes ocultos.

The concealed form T-15 through an inverted "T" simplifies the installation of hidden edge panels.

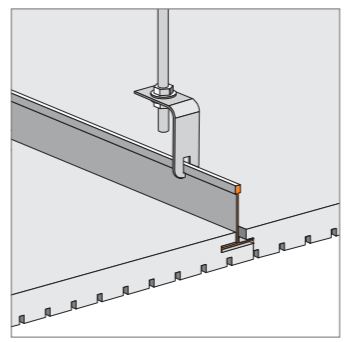

### PERFIL SEMIVISTO T-15/T-24 SEMI-EXPOSED FORM T-15/T-24

El sistema de perfilera semivisto T-15 T-24 oculta parcialmente el perfil dejando una fina línea que añade elegancia a la solución.

The semi-exposed form hides partially the profile leaving a fine line that adds elegance to the solution.

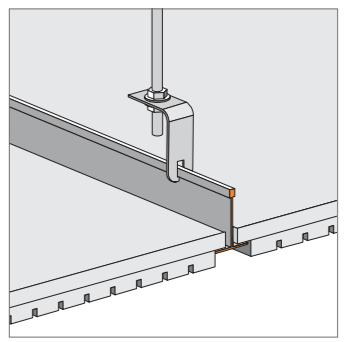

### PERFIL OCULTO T-24 + GRAPA CONCEALED FORM T-24 + CRAMP

El sistema de perfilera oculo T-24 con grapa de fijación consigue un techo estéticamente impecable.

The concealed form T-24 with fixing iron cramp achieves an aesthetic incredible ceiling.

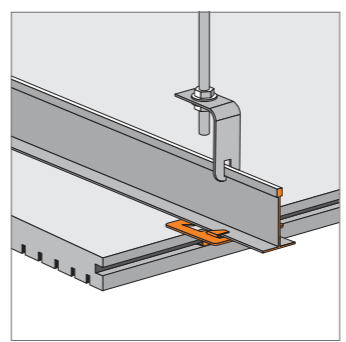

### PERFIL OMEGA + GRAPA OMEGA PROFILE + CRAMP

El sistema omega + grapa consiste en la instalación de los paneles a través de un perfil "U" y grapas metálicas.

The system omega profile + cramp consists on the installation of panels through a "U" profile and iron cramps.

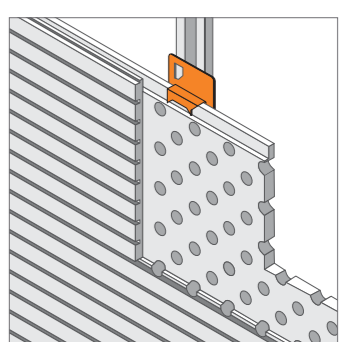

### RASTREL MADERA + GRAPA WOODEN STRIP + CRAMP

El sistema rastrel de madera + grapa consiste en la instalación de los paneles mediante rastreles y grapas auxiliares.

The system of wooden strip + cramp consists on the installation of panels through wooden strips and cramps.

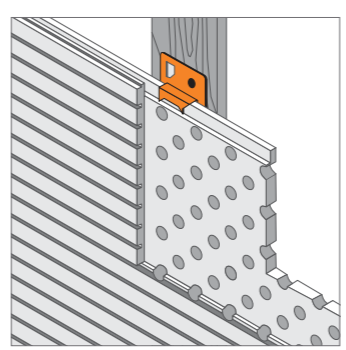

### RASTREL MADERA WOODEN STRIP

El sistema rastrel de madera permite la colocación de los paneles mediante puntas claveteadas al rastrel fijado a la pared.

The system of wooden strip allows the collocation of panels through nails to wooden strip fixed to the wall.

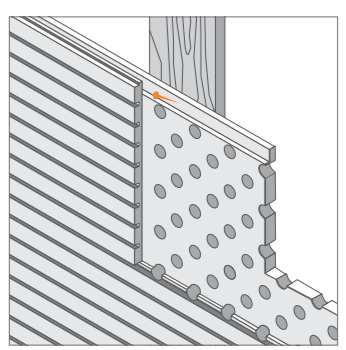



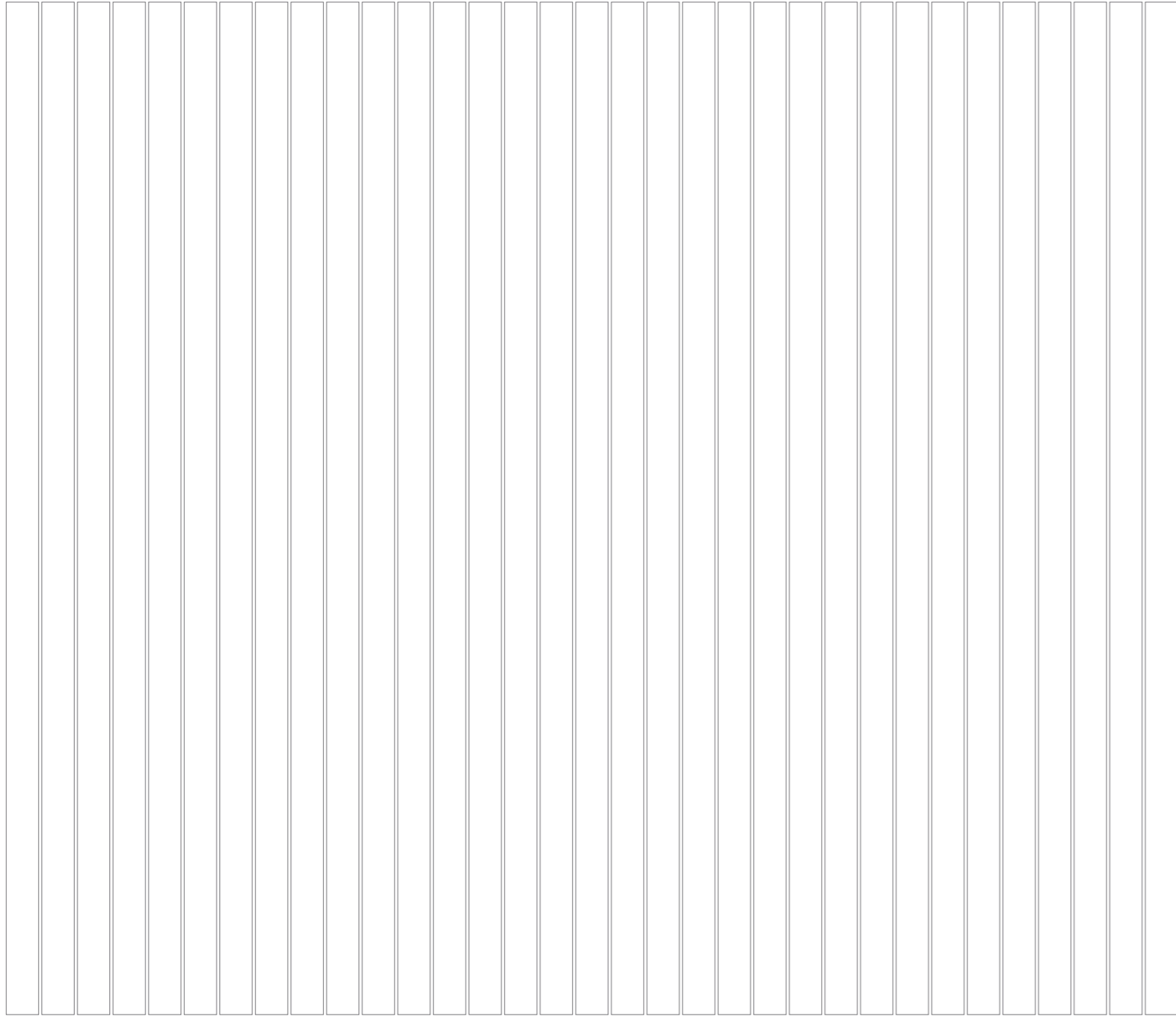

# Acabados Finishes

## MELAMINA MELAMINE

Melaminas en stock Stock melamines

Blanco White	Inox Inox	Maple Maple	Haya Beech	Roble Oak	Peral Pearl	Cerezo Cherry	Wengué Wengue
-----------------	--------------	----------------	---------------	--------------	----------------	------------------	------------------

Otros acabados en melamina, consultar. If others finishes are required, please consult us.

Espeor Thickness	16 mm
Peso Weight	14 kg/m² aprox.

## MADERA NATURAL NATURAL WOOD

Madera natural barnizada Varnished veneer

Maple Maple	Haya Beech	Roble Oak	Cerezo Cherry
----------------	---------------	--------------	------------------

Otros acabados en madera, consultar. If others finishes are required, please consult us.

Espeor Thickness	16 mm
Peso Weight	14 kg/m² aprox.

## DM TEÑIDO EN MASA MASS-DYED DM

DM teñido Mass-dyed DM

Azul Blue	Rojo Red	Amarillo Yellow	Verde Green	Gris Grey
--------------	-------------	--------------------	----------------	--------------

Otros acabados en DM teñido, consultar. If others finishes are required, please consult us.

Espeor Thickness	16 mm
Peso Weight	14 kg/m² aprox.

## LACADO LACQUER

Capacidad de adaptar nuestros paneles a cualquier referencia de las cartas RAL, PANTONE y NCS.

Spigogroup has the capacity of adapting the panels to any reference of RAL, PANTONE or NCS card.



Espeor Thickness	16 mm
Peso Weight	14 kg/m² aprox.

## HPL LAMINATED HPL

Aplacados de laminados de alta densidad (HPL) con altas prestaciones térmicas y resistentes.

High density laminated cladding (HPL) above chosen support.

Espeor Thickness	16 mm
Peso Weight	Variable

## PLAZOS DE FABRICACIÓN PRODUCTION DEADLINES

Melaminas en stock Stock melamine	10-15 días days
Melaminas fuera de stock Non-stock melamine	6-7 semanas weeks
Madera natural Natural wood	3-4 semanas weeks
Lacados Lacquers	3-4 semanas weeks
HPL Laminated HPL	4-5 semanas weeks
DM teñido en masa Mass-Dyed DM	Consultar Consult

⚠ Plazo exacto a la formalización del pedido. Production deadlines will be given in a precise way, when the purchase order will be accepted.

# Soportes Supports

## MDF ESTÁNDAR STANDARD MDF



Soporte de fibras de madera de densidad media (MDF) destinado para un uso en ambientes secos.

Medium-density fiberboard support is destined to an use in dry environments.

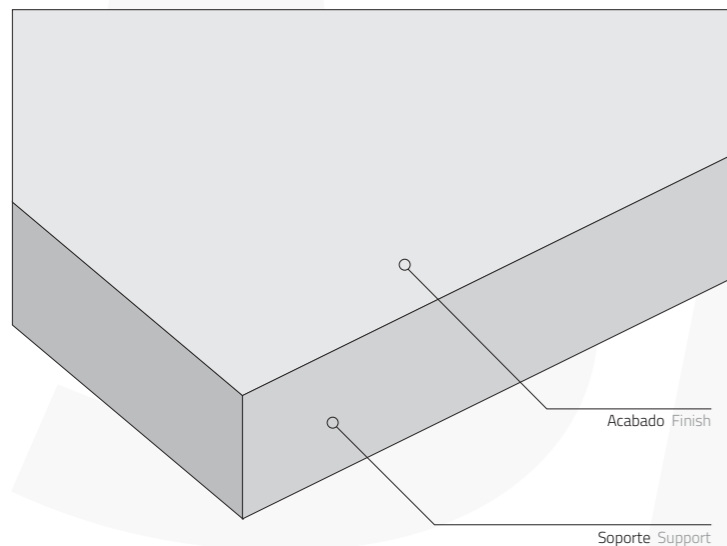

Densidad Density	kg/m <sup>3</sup>	720
Resistencia flexión Bending strength	N/mm <sup>2</sup>	20
Módulo elasticidad Modulus of elasticity	N/mm <sup>2</sup>	2200
Estab. dimensional <sup>1</sup> Dimensional movement	%	0,4
Estab. dimensional <sup>2</sup> Dimensional movement	%	6
Formaldehido Formaldehyde content	mg/100g	E1
Reacción al fuego Fire-reaction	Clase	D-s2,d0

<sup>1</sup> Largo/ancho Large/width <sup>2</sup> Espesor Thickness

Valores medios aproximados Approximate mean values

## MDF IGNÍFUGO FIRE-RETARDANT MDF



Soporte de fibras de madera de densidad media (MDF) con reacción mejorada al fuego.

Medium-density fiberboard support with improved fire reaction.

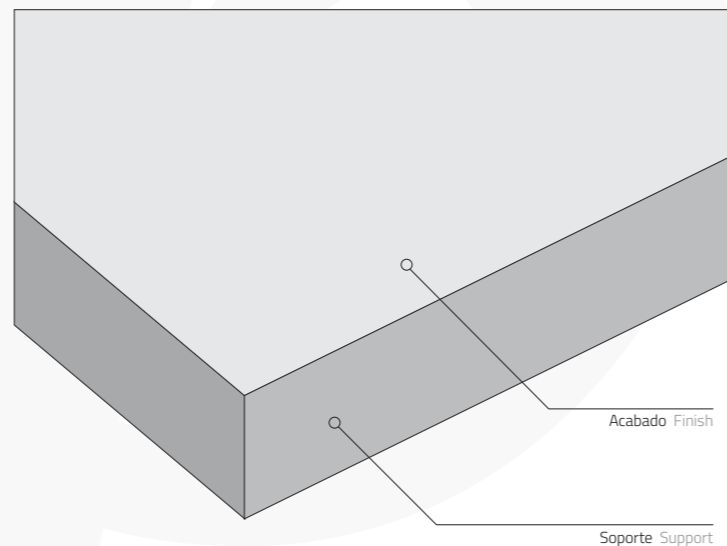

Densidad Density	kg/m <sup>3</sup>	790
Resistencia flexión Bending strength	N/mm <sup>2</sup>	20
Módulo elasticidad Modulus of elasticity	N/mm <sup>2</sup>	2200
Estab. dimensional <sup>1</sup> Dimensional movement	%	0,5
Estab. dimensional <sup>2</sup> Dimensional movement	%	7
Formaldehido Formaldehyde content	mg/100g	E1
Reacción al fuego Fire-reaction	Clase	B-s1,d0

<sup>1</sup> Largo/ancho Large/width <sup>2</sup> Espesor Thickness

Valores medios aproximados Approximate mean values

## MDF HIDRÓFUGO MOISTURE-RESISTANT MDF



Soporte de fibras de madera de densidad media (MDF) para su utilización en ambientes húmedos.

Medium-density fiberboard support which is resistant to moisture.

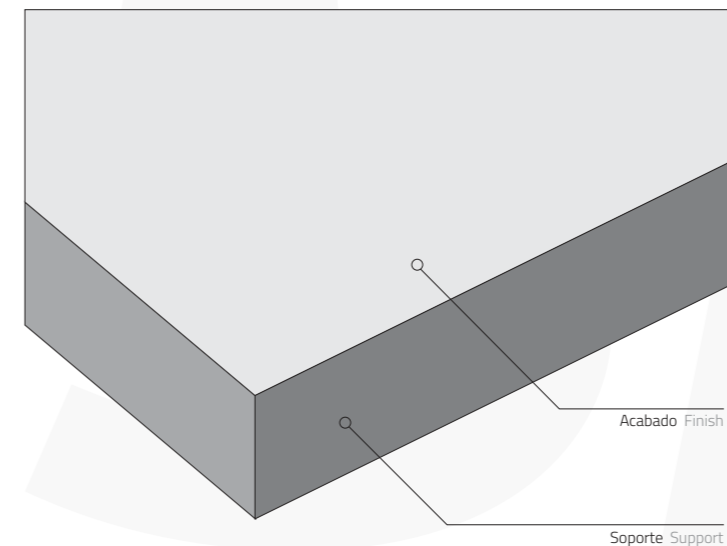

Densidad Density	kg/m <sup>3</sup>	745
Resistencia flexión Bending strength	N/mm <sup>2</sup>	24
Módulo elasticidad Modulus of elasticity	N/mm <sup>2</sup>	2400
Estab. dimensional <sup>1</sup> Dimensional movement	%	0,3
Estab. dimensional <sup>2</sup> Dimensional movement	%	5
Formaldehido Formaldehyde content	mg/100g	E1
Reacción al fuego Fire-reaction	Clase	D-s2,d0

<sup>1</sup> Largo/ancho Large/width <sup>2</sup> Espesor Thickness

Valores medios aproximados Approximate mean values

# Acústica Acoustic

La calidad final de un espacio constructivo viene determinada por multitud de factores y por supuesto, el aspecto acústico es muy relevante. Un mal ambiente acústico envolvente provoca dificultades de comunicación, estrés, falta de concentración y cansancio.

La corrección acústica se manifiesta hoy en día como una condición necesaria para crear buenos ambientes interiores. Este concepto es el que desarrollan los paneles de madera Spigogroup, diseñados para ofrecer los niveles de inteligibilidad, confidencialidad, concentración y tiempo de reverberación óptimos para cada lugar. Además, no sólo son los productos idóneos para conseguir un acondicionamiento acústico óptimo, sino que también incorporan una cuidada armonía estética acorde con los más exigentes proyectos. Cuando queremos diseñar y alcanzar un óptimo resultado en el acondicionamiento acústico de un recinto, tres son los principales aspectos a tratar:

The final quality of a constructive space is determined by multiple factors, including the acoustic aspect which is very relevant. A negative enveloping acoustic atmosphere causes communication difficulties, stress, lack of concentration and fatigue.

Nowadays, the acoustic correction states like a necessary condition to create good interior environment. Spigogroup's panels develop this concept. They are designed to offer optimum levels of intelligibility, confidentiality, concentration and optimum time reverberation for each place. Furthermore, are they not only appropriate products to reach an optimum acoustic conditioning, but also incorporate a carefully-composed aesthetic harmony in accordance with the most exigent projects. When we want to design and reach an optimum result in the acoustic conditioning from a space, there are three main aspects to treat:

	TRATADA MEDIANTE TREATED THROUGH		
<b>REFLEXIÓN REFLECTION</b>	Mat. no porosos Non porous mat.	Mat. rígidos Rigid material	Mat. lisos Plain mat.
<b>ABSORCIÓN ABSORTION</b>	Mat. porosos Porous mat.	Resonadores Resonator	Mobiliario Furniture
<b>DIFUSIÓN DIFUSION</b>	Elem. en techo Ceiling elements	Paredes sierra Saw walls	Difusores Difusors

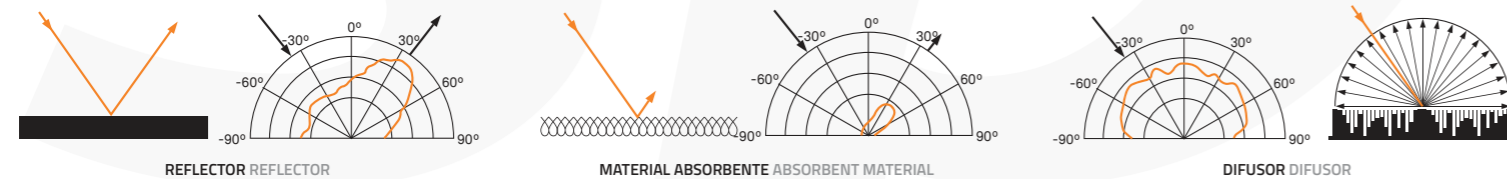

La calidad de la absorción acústica viene determinada por el diseño del espacio y los materiales utilizados. En concreto los paneles Spigogroup presentan unas excelentes propiedades de absorción acústica. Cuando las ondas del sonido incidentes llegan a un material absorbente como los paneles Spigogroup, una parte de la energía se refleja, otra parte es absorbida por el material y el resto se transmite.

The quality of acoustic absorption is determined by the design of space and used material. In particular, Spigogroup panels, which are made with natural wood, show excellent properties of acoustic absorption. When incident sound waves reach absorbent material like Spigogroup panels, one part of energy is reflected, another is absorbed by the material and the rest is transmitted.

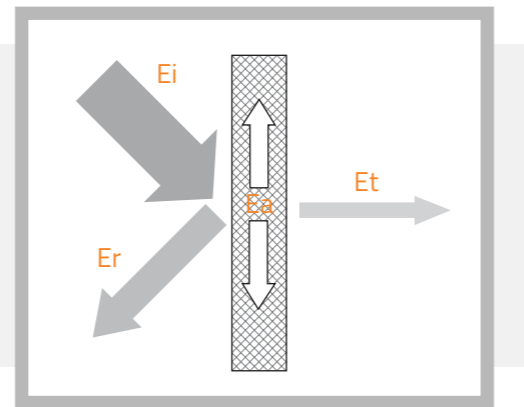

Para dar solución o tratamiento de acondicionamiento acústico se utilizan los llamados resonadores acústicos. Este tipo de elementos se caracterizan por tener una frecuencia de resonancia en la cual la absorción es máxima haciendo de ellos unos materiales muy selectivos para los diferentes diseños acústicos que se requieran. Los más comunes son:

Acoustic resonators are used to give solution or acoustic conditioning treatment. This type of elements is characterized by having a resonance frequency in which the absorption is maxim. Therefore, these materials are very selective to the different acoustic designs which are required. The most common are:

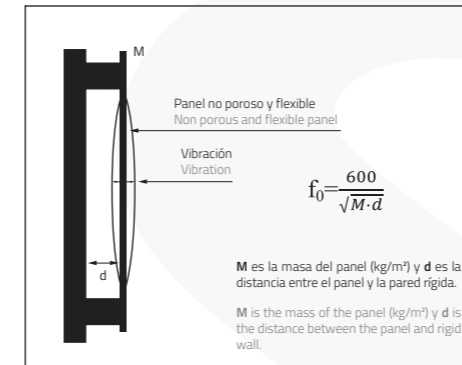

RESONADOR DE MEMBRANA  
RESONATOR OF MEMBRANE

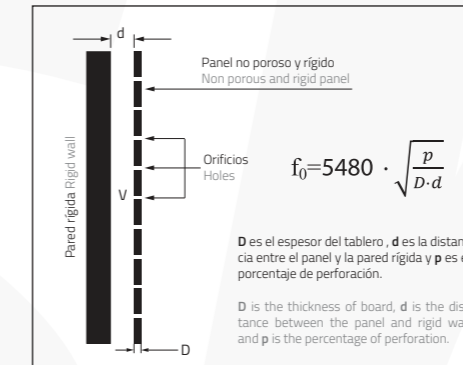

RESONADOR DE HELMHOLTZ A BASE DE PERFORACIONES Y RANURAS  
RESONATOR OF HELMHOLTZ BASED ON PERFORATIONS AND OVOIDS

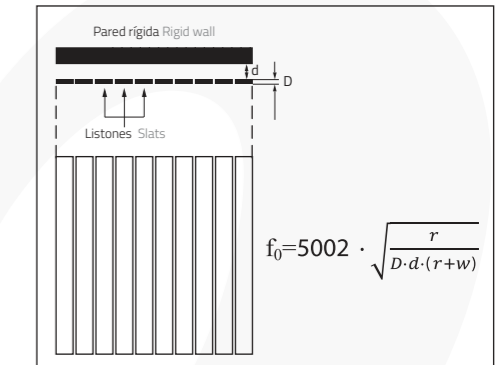

RESONADOR DE HELMHOLTZ A BASE DE LISTONES  
RESONATOR OF HELMHOLTZ BASED ON SLATS

## COEFICIENTE DE ABSORCIÓN ABSORPTION COEFFICIENT

Denominamos coeficiente de absorción  $\alpha$  a la relación entre la energía absorbida y la energía incidente.

It is called Absorption Coefficient  $\alpha$  to the relation between absorbed energy and incidental energy.

$$\alpha = \frac{\text{Energía absorbida}}{\text{Energía incidente}}$$

## REVERBERACIÓN REVERBERATION

Se define como el tiempo transcurrido en disminuir 60 dB la energía que recibe el receptor desde el momento que la fuente emisora deja de emitir sonido.

This concept is defined like the time elapsed to decrease 60dB the energy that receives the receptor from the moment which the sound source stops emitting sound.

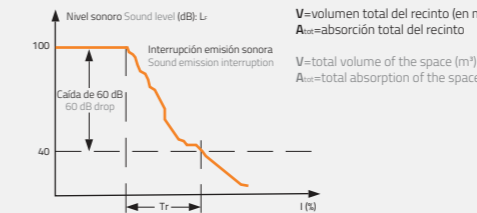

## Tiempos de reverberación óptimos Optimum Reverberation Times

SALAS ROOMS		TR Medio 1 kHz y 500 Hz Sala ocupada RT Medium 1kHz and 500Hz occupied room
Sala de conferencias Conference room		0.7-1.0
Cine Cinema		1.0-1.2
Sala polivalente Multi-use room		1.2-1.5
Teatro de ópera Opera theatre		1.2-1.5
Música de cámara Chamber music		1.3-1.7
Música sinfónica Symphony music		1.8-2.0
Iglesia/Catedral Church/Cathedral		2.0-3.0
Locutorio de radio Radio Studio		0.2-0.4



A través de nuestra aplicación disponible online, se podrá calcular el Tiempo de Reverberación Óptimo y conseguir unos resultados orientativos que ayuden a la toma de decisiones sobre el acondicionamiento acústico de diferentes recintos.

Through our online available application, it will be able to calculate the Optimum Reverberation Time and get orientative results that help decision making about acoustic conditioning of different areas.

[www.spigogroup.com](http://www.spigogroup.com)

# Modelos Models

Porcentaje de perforación	Percentage of perforation	% perf.
Coefficiente medio de absorción	Average absorption coefficient	$\bar{\alpha}_m$
Coefficiente en baja, media y alta frecuencia	Low, medium and high frequency	$\bar{\alpha}_b / \bar{\alpha}_m / \bar{\alpha}_a$
Coefficiente de reducción de ruido	Noise reduction coefficient	NRC

LISO

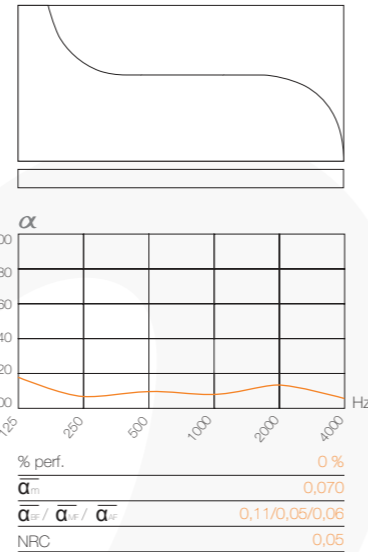

20-16-16

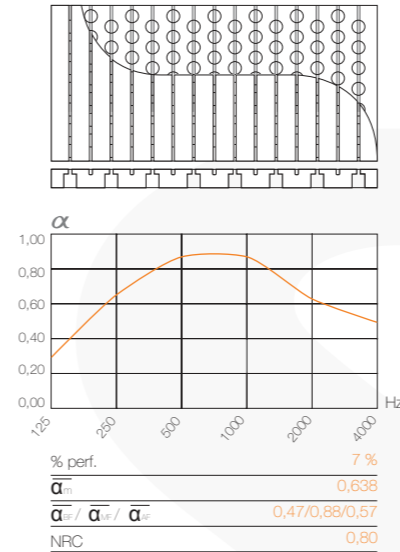

20-16-32

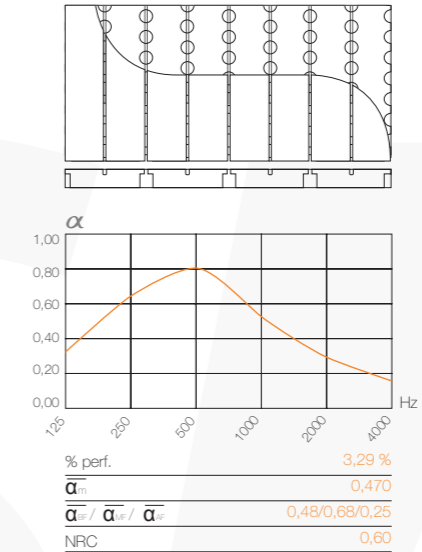

20-16-64

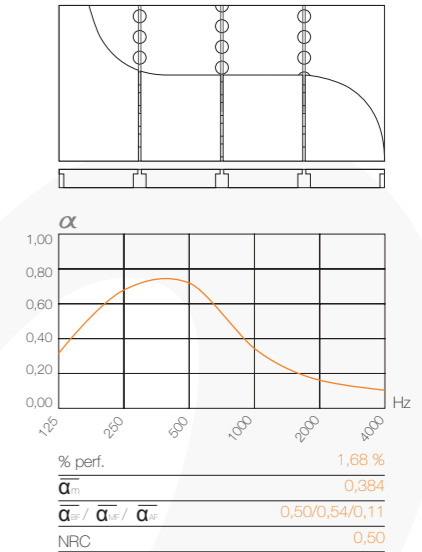

20-32-8

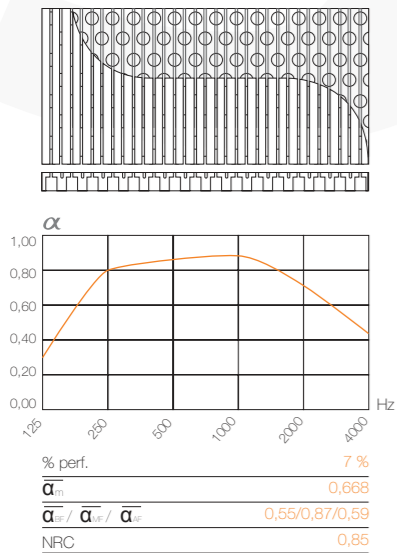

20-32-16

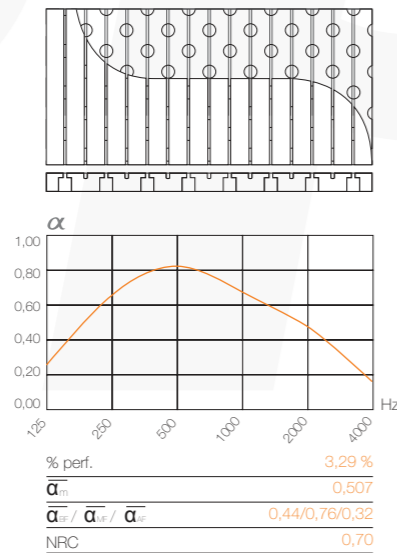

20-32-32

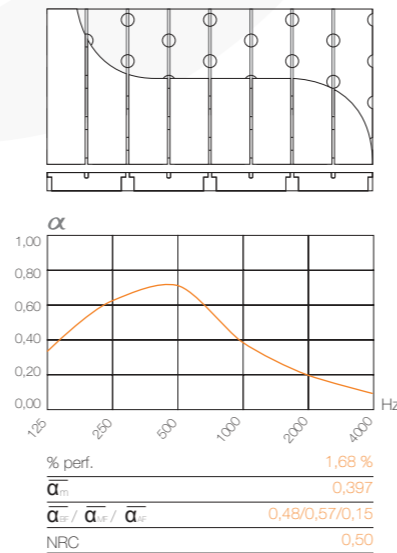

20-32-64

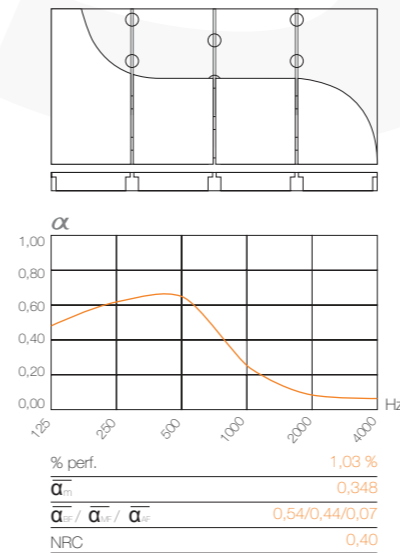

20-NO-16

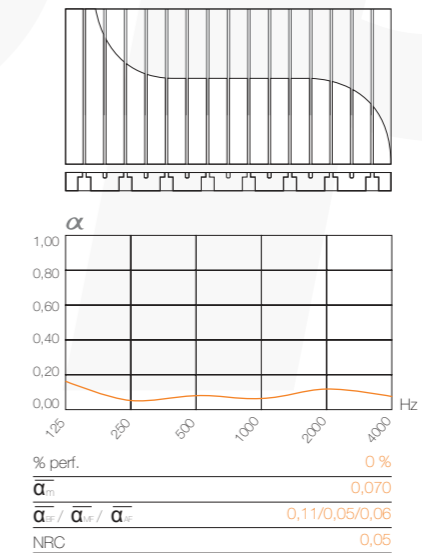

20-NO-32

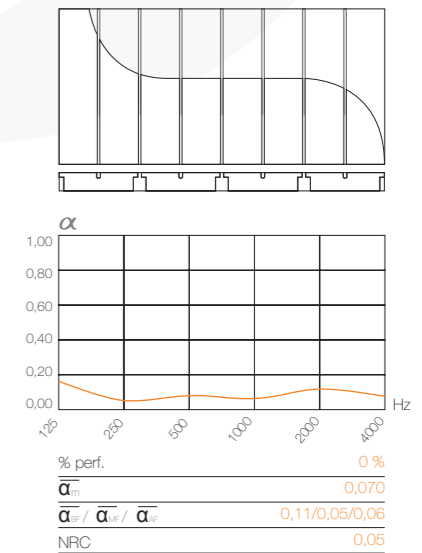

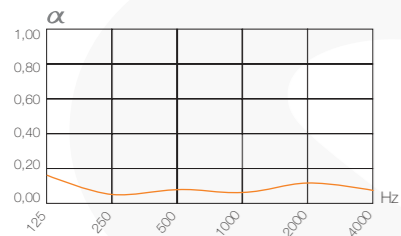
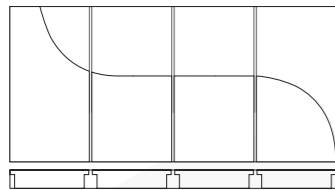
**20-NO-64**

% perf.	0 %
$\bar{\alpha}_m$	0,070
$\bar{\alpha}_{125} / \bar{\alpha}_{500} / \bar{\alpha}_{2000}$	0,11/0,05/0,06
NRC	0,05

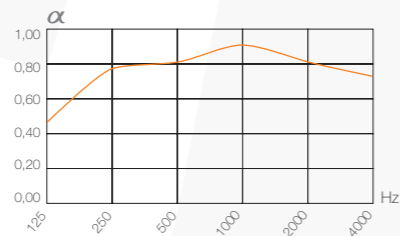
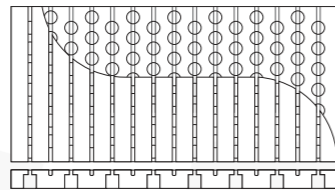
**28-16-16**

% perf.	11,25 %
$\bar{\alpha}_m$	0,791
$\bar{\alpha}_{125} / \bar{\alpha}_{500} / \bar{\alpha}_{2000}$	0,64/0,85/0,81
NRC	0,85

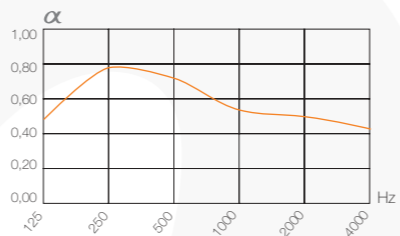
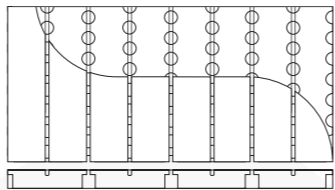
**28-16-32**

% perf.	5,45 %
$\bar{\alpha}_m$	0,585
$\bar{\alpha}_{125} / \bar{\alpha}_{500} / \bar{\alpha}_{2000}$	0,63/0,66/0,42
NRC	0,65

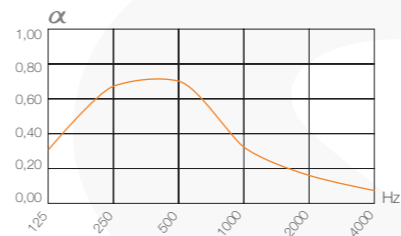
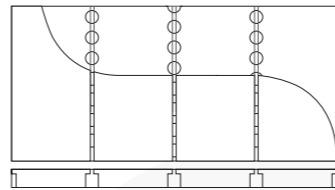
**28-16-64**

% perf.	2,81 %
$\bar{\alpha}_m$	0,471
$\bar{\alpha}_{125} / \bar{\alpha}_{500} / \bar{\alpha}_{2000}$	0,64/0,53/0,24
NRC	0,55

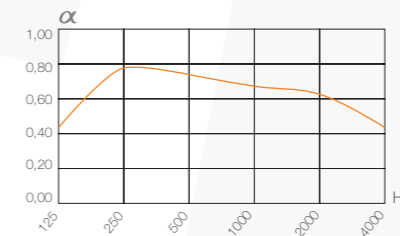
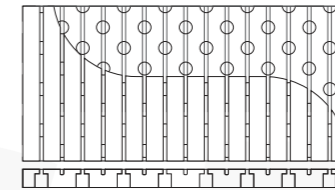
**28-32-16**

% perf.	5,45 %
$\bar{\alpha}_m$	0,705
$\bar{\alpha}_{125} / \bar{\alpha}_{500} / \bar{\alpha}_{2000}$	0,50/0,91/0,69
NRC	0,85

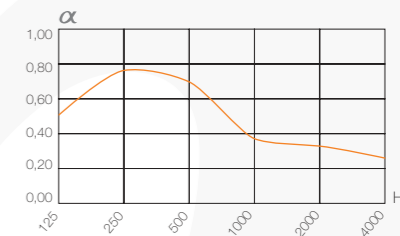
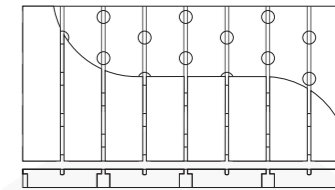
**28-32-32**

% perf.	2,81 %
$\bar{\alpha}_m$	0,502
$\bar{\alpha}_{125} / \bar{\alpha}_{500} / \bar{\alpha}_{2000}$	0,52/0,62/0,37
NRC	0,60

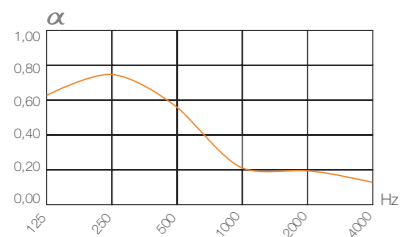
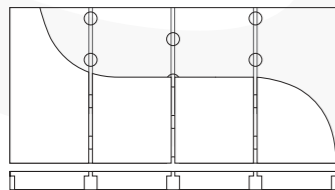
**28-32-64**

% perf.	1,45 %
$\bar{\alpha}_m$	0,413
$\bar{\alpha}_{125} / \bar{\alpha}_{500} / \bar{\alpha}_{2000}$	0,56/0,47/0,21
NRC	0,45

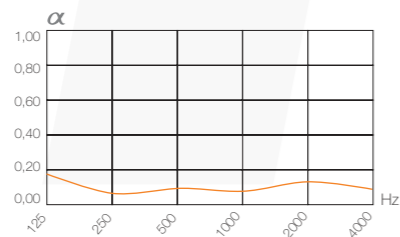
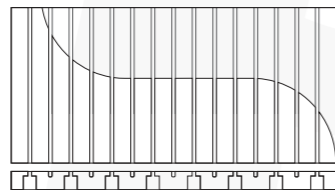
**28-NO-16**

% perf.	0 %
$\bar{\alpha}_m$	0,070
$\bar{\alpha}_{125} / \bar{\alpha}_{500} / \bar{\alpha}_{2000}$	0,11/0,05/0,06
NRC	0,05

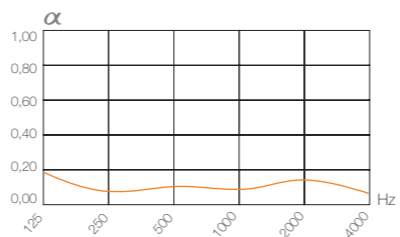
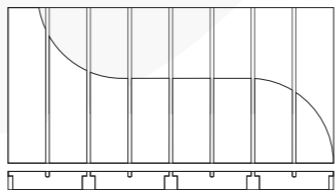
**28-NO-32**

% perf.	0 %
$\bar{\alpha}_m$	0,070
$\bar{\alpha}_{125} / \bar{\alpha}_{500} / \bar{\alpha}_{2000}$	0,11/0,05/0,06
NRC	0,05

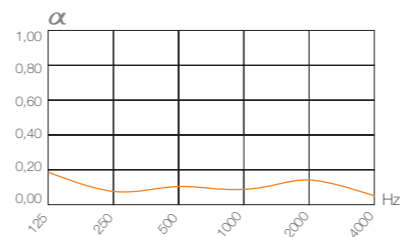
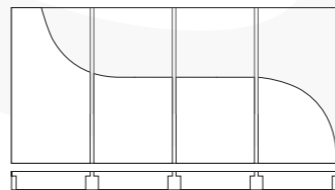
**28-NO-64**

% perf.	0 %
$\bar{\alpha}_m$	0,070
$\bar{\alpha}_{125} / \bar{\alpha}_{500} / \bar{\alpha}_{2000}$	0,11/0,05/0,06
NRC	0,05

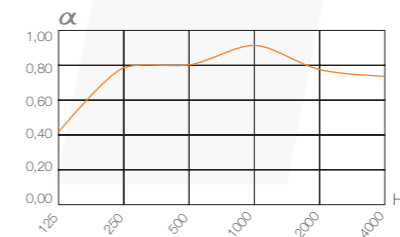
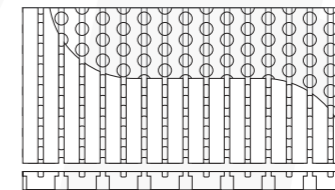
**42-16-16**

% perf.	17,50 %
$\bar{\alpha}_m$	0,698
$\bar{\alpha}_{125} / \bar{\alpha}_{500} / \bar{\alpha}_{2000}$	0,56/0,90/0,62
NRC	0,85

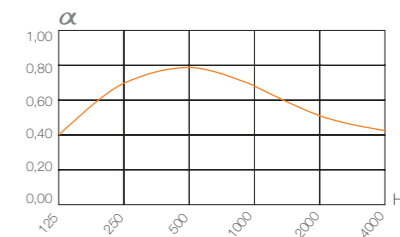
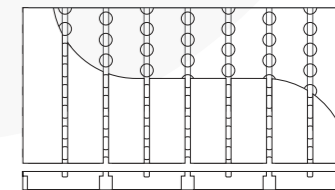
**42-16-32**

% perf.	8,18 %
$\bar{\alpha}_m$	0,550
$\bar{\alpha}_{125} / \bar{\alpha}_{500} / \bar{\alpha}_{2000}$	0,32/0,92/0,42
NRC	0,70

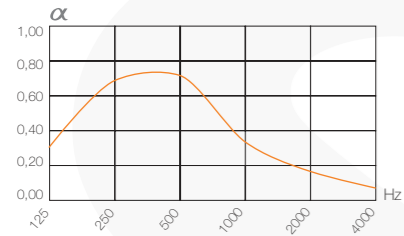
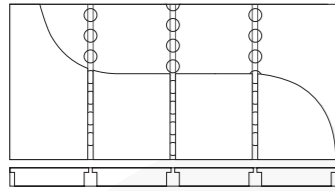
**42-16-64**

% perf.	4,36 %
$\bar{\alpha}_m$	0,445
$\bar{\alpha}_w / \bar{\alpha}_v / \bar{\alpha}_f$	0,28/0,80/0,26
NRC	0,55

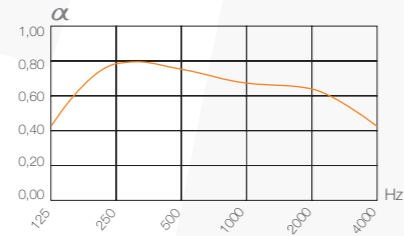
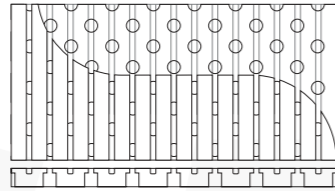
**42-32-16**

% perf.	8,18 %
$\bar{\alpha}_m$	0,593
$\bar{\alpha}_w / \bar{\alpha}_v / \bar{\alpha}_f$	0,56/0,57/0,55
NRC	0,65

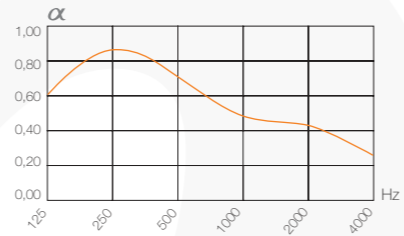
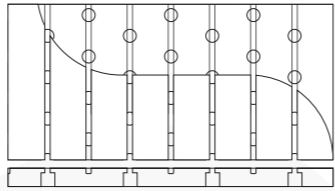
**42-32-32**

% perf.	4,36 %
$\bar{\alpha}_m$	0,671
$\bar{\alpha}_w / \bar{\alpha}_v / \bar{\alpha}_f$	0,77/0,82/0,47
NRC	0,80

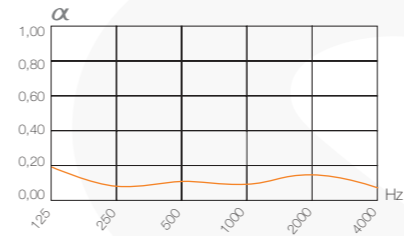
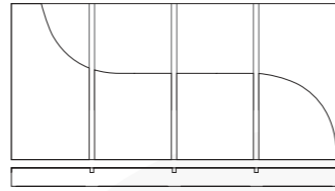
**42-NO-64**

% perf.	0 %
$\bar{\alpha}_m$	0,070
$\bar{\alpha}_w / \bar{\alpha}_v / \bar{\alpha}_f$	0,11/0,05/0,06
NRC	0,05

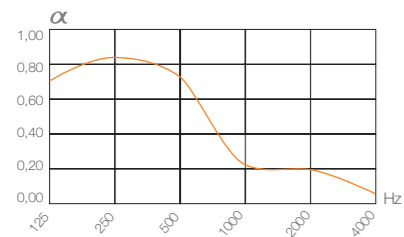
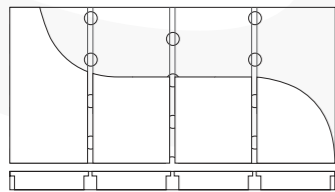
**42-32-64**

% perf.	2,23 %
$\bar{\alpha}_m$	0,678
$\bar{\alpha}_w / \bar{\alpha}_v / \bar{\alpha}_f$	0,84/0,81/0,33
NRC	0,65

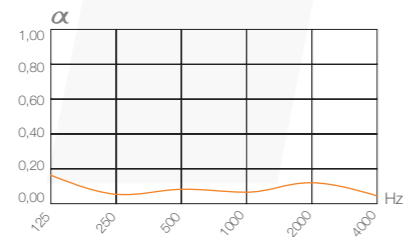
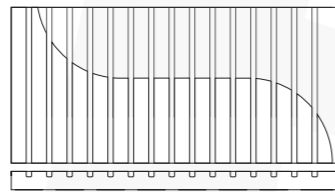
**42-NO-16**

% perf.	0 %
$\bar{\alpha}_m$	0,070
$\bar{\alpha}_w / \bar{\alpha}_v / \bar{\alpha}_f$	0,11/0,05/0,06
NRC	0,05

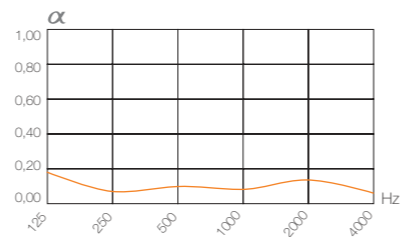
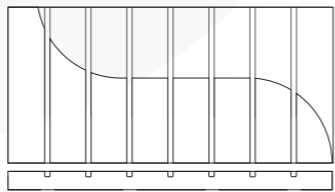
**42-NO-32**

% perf.	0 %
$\bar{\alpha}_m$	0,070
$\bar{\alpha}_w / \bar{\alpha}_v / \bar{\alpha}_f$	0,11/0,05/0,06
NRC	0,05

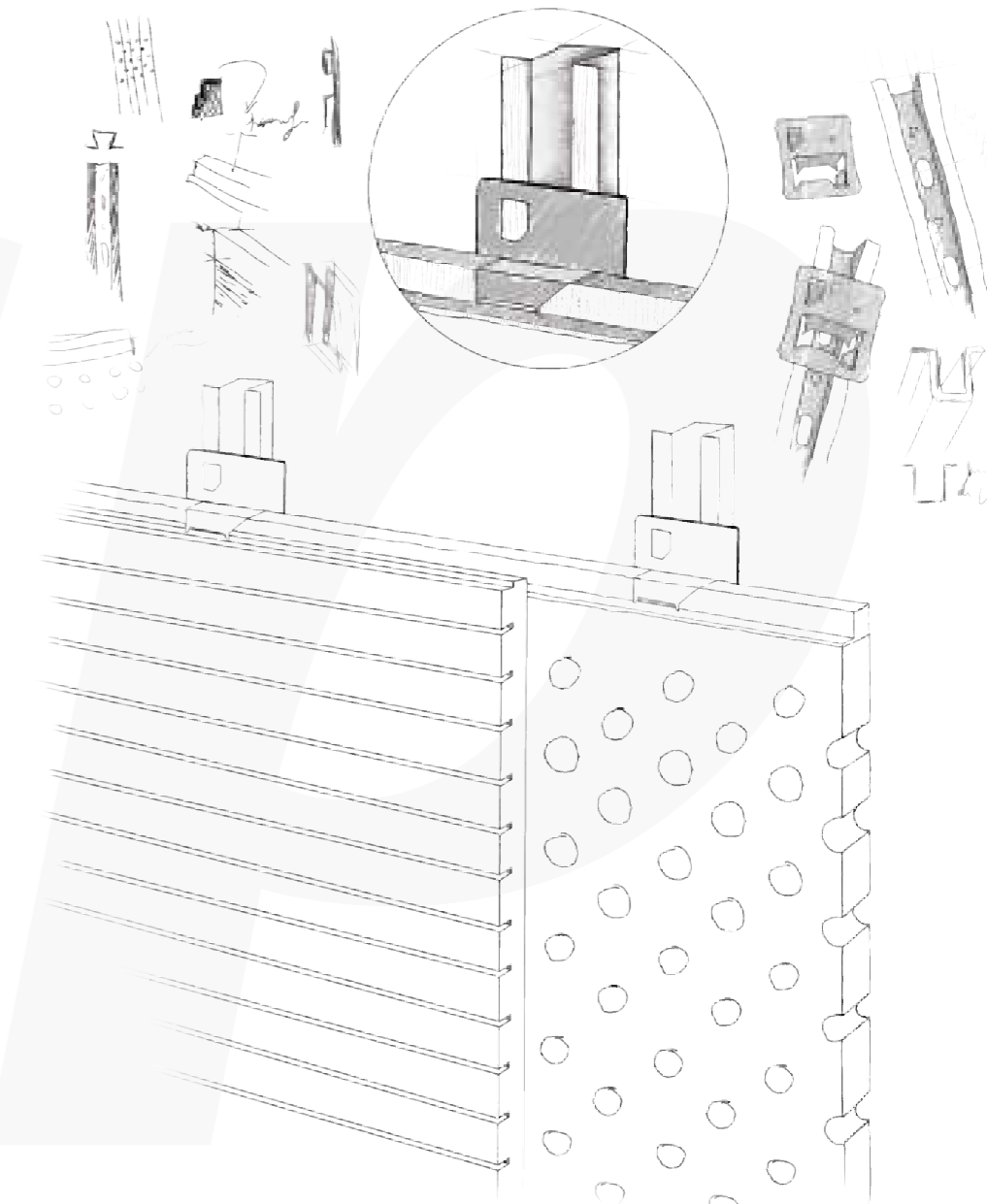

# Mecanizados de instalación Installation machining

## PERFIL OCULTO T-15 CONCEALED FORM T-15

El sistema de perfilera oculta T-15 simplifica la instalación de las placas de techo desmontable con bordes ocultos. A través de una "T" invertida las placas van atestadas y se apoyan en la misma quedando la perfilera de sujeción oculta entre ellas. Permite un muy fácil desmontaje de la placas para su mantenimiento o para acceder a las instalaciones técnicas integradas en el techo.

The system of concealed form T-15 simplifies the installation panels with hidden edges. The panels are supported by the inverted "T". In this way the profile is hidden between them. This system allows a very easy dismantling in order to their maintaining or to allow access to technical integrated installations in the ceiling.

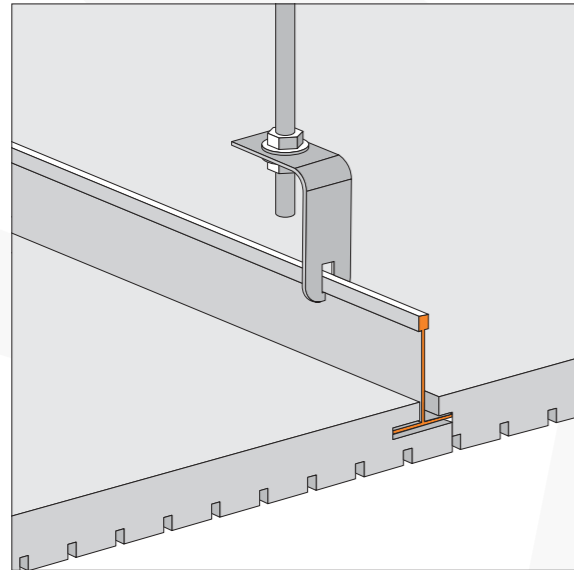

TECHOS CEILINGS	MEDIDAS COMERCIALES COMMERCIAL SIZES	MEDIDAS REALES REAL SIZES
	1200x300 mm	1200x288 / 1200x256 <sup>1</sup> mm

## PERFIL SEMIVISTO T-15/T-24 SEMI-EXPOSED FORM T-15/T-24

El sistema de perfilera semivisto T-15/T-24 oculta parcialmente el perfil dejando una fina línea que añade elegancia a la solución. El panel descansa sobre la perfilera de sujeción y gracias al mecanizado perimetral queda suspendido por debajo de la misma. Con esto se consigue resaltar las medidas de los paneles y las entrecalles que se forman entre los mismos.

The system of semi-exposed form T-15 / T-24 hides partially the profile leaving a fine line that adds elegance to the solution. The panel rests above fastening profiles. This system succeeds in emphasizing the dimensions and forms of the panels which are made between them.

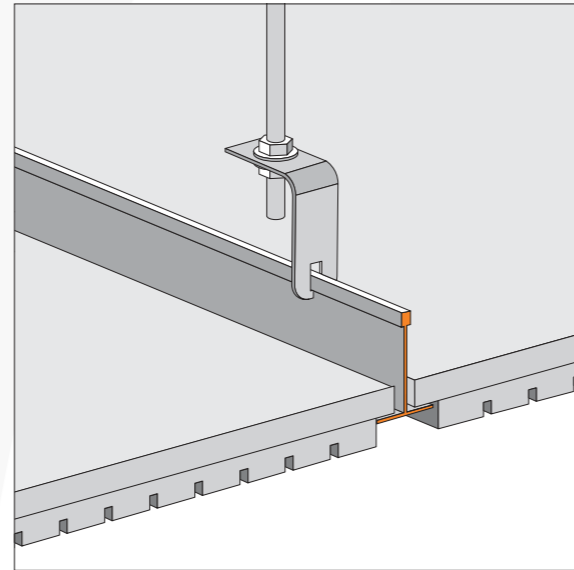

TECHOS CEILINGS	MEDIDAS COMERCIALES COMMERCIAL SIZES	MEDIDAS REALES REAL SIZES
	1200x300 mm	1200x294 mm
	1200x600 mm	1194x594 mm
	600x600 mm	594x594 mm

## PERFIL OCULTO T-24 + GRAPA CONCEALED FORM T-24 + CRAMP

El sistema de perfilera oculta T-24 con grapa de fijación consigue a través de la perfilera y el anclaje mediante grapas metálicas un techo estéticamente impecable, fijo y no desmontable, dónde tanto la perfilera como los anclajes permanecen ocultos una vez terminada la instalación de la obra.

The system of concealed form T-24 with fixing iron cramp achieves through the profile and the anchoring by iron cramps an aesthetic incredible ceiling in which the profile and the anchoring are hidden when the installation has been finished.

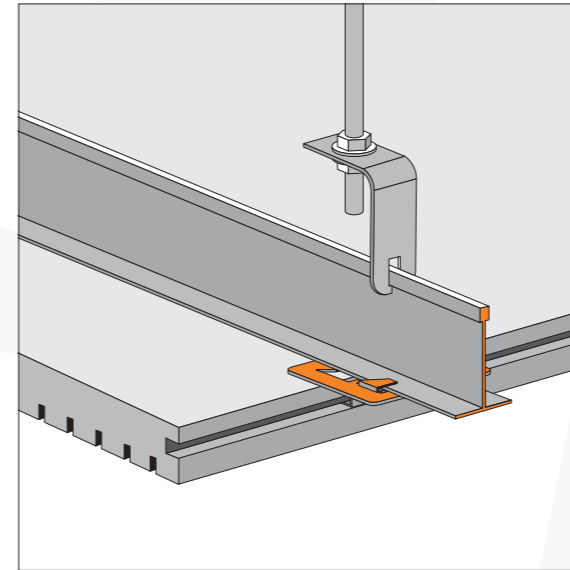

TECHOS CEILINGS	MEDIDAS COMERCIALES COMMERCIAL SIZES	MEDIDAS REALES REAL SIZES
	1200x300 mm	1200x288 / 1200x256 <sup>1</sup> mm
	2400x300 mm	2400x288 / 2400x256 <sup>1</sup> mm

## PERFIL OMEGA + GRAPA OMEGA FORM + FIXING CRAMP

El sistema omega + grapa de fijación consiste en la instalación de los paneles a través de un perfil metálico en forma de "U". Los paneles se fijan a la base de apoyo en la pestaña de la hembra con las grapas auxiliares. La pestaña macho del siguiente panel se superpone sobre la pestaña de la hembra, ocultando a esta y la fijación.

The system omega form + fixing iron cramp consists on installation of panels through a "U". The panels are fixed by an iron cramp in female edge and the following male edge is superimposed onto female edge. In this way the iron camp is hidden.

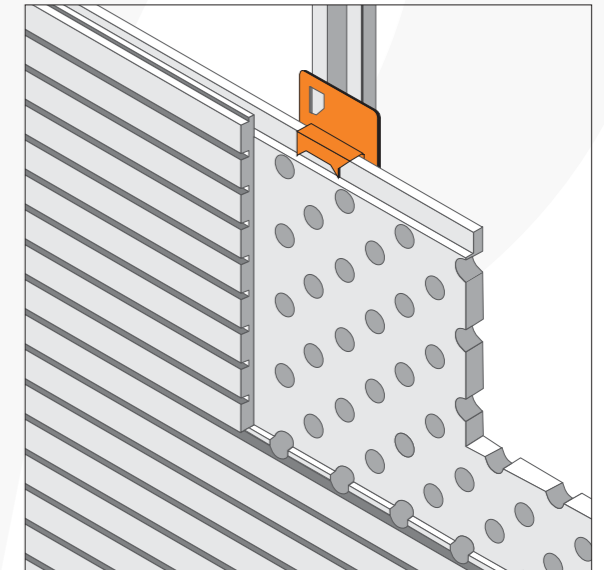

PAREDES WALLS	MEDIDAS COMERCIALES COMMERCIAL SIZES	MEDIDAS REALES REAL SIZES
	1200x300 mm	1200x288 / 1200x256 <sup>1</sup> mm
	2400x300 mm	2400x288 / 2400x256 <sup>1</sup> mm

<sup>1</sup> La medida real 1200x256 mm corresponde a los modelos de canal 64 mm.  
<sup>1</sup> The real size 1200x256 mm corresponds to models with channel 64 mm.

# Condiciones de instalación Installation conditions

## RASTREL DE MADERA + GRAPA WOODEN STRIP + CRAMP

El sistema rastrel de madera + grapa de fijación permite la colocación de los paneles mediante unos rastreles de madera fijados a la pared y unas grapas auxiliares. Mediante esta técnica de encaje se consigue una apariencia de ausencia de cortes quedando las fijaciones ocultas.

The system wooden strip + fixing iron cramp allows the collocation of panels through some strips fixed to the wall and some iron cramps. By means of this anchoring it is achieved an appearance of cut absence. Furthermore, the fixings are hidden.

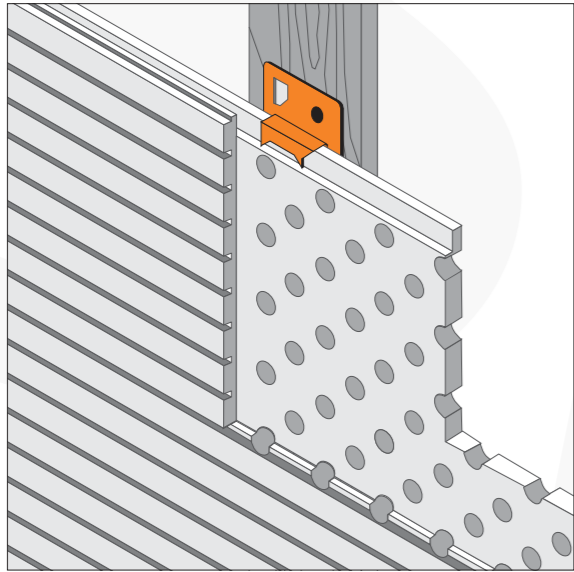

PAREDES WALLS	MEDIDAS COMERCIALES COMMERCIAL SIZES	MEDIDAS REALES REAL SIZES
	1200x300 mm	1200x288 / 1200x256 <sup>1</sup> mm
	2400x300 mm	2400x288 / 2400x256 <sup>1</sup> mm

<sup>1</sup> La medida real 1200x256 mm corresponde a los modelos de canal 64.  
<sup>1</sup> The real size 1200x256 mm corresponds to models with channel 64 mm.

## RASTREL DE MADERA WOODEN STRIP

El sistema rastrel de madera sin grapa de fijación permite la colocación de los paneles mediante puntas al rastrel fijado a la pared. Dicho rastrelado previo debe ser colocado perpendicular a la posición de los paneles.

The system wooden strip without fixing iron cramp allows the collocation of panels through nails to strip fixed to the wall. These strips are put perpendiculars to the position of panels.

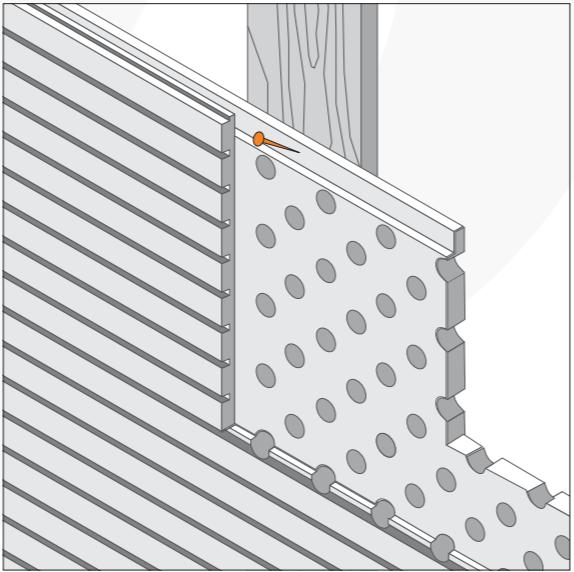

PAREDES WALLS	MEDIDAS COMERCIALES COMMERCIAL SIZES	MEDIDAS REALES REAL SIZES
	1200x300 mm	1200x288 / 1200x256 <sup>1</sup> mm
	2400x300 mm	2400x288 / 2400x256 <sup>1</sup> mm

1.- El material debe ser desembalado en el momento de su colocación. Para la idónea adaptación de los paneles al ambiente, se recomienda mantenerlos entre 24/48 horas antes en el lugar para su aclimatación.

2.- El embalaje original no protege el material de la lluvia, humedad, impactos, etc. No se deberá colocar ninguna carga sobre el material.

3.- Los locales deberán estar cubiertos salvo que el material esté adaptado para ello y se haya acordado esa posibilidad.

4.- El entorno no debería estar con humedades superiores al 60%.

5.- Elementos como ventanas abiertas, calefacción, aire acondicionado, etc... afectan al material pudiendo hacer que las placas se contraigan y/o dilaten si las temperaturas no se mantienen estables. Estos efectos del material y sus posibles caídas, separaciones, etc... no son responsabilidad de la empresa fabricante.

6.- Las tolerancias en dimensiones por placa pueden variar en un +/- 0,4% tanto en longitud como en anchura según indicaciones del fabricante del soporte utilizado.

7.- Se recomienda dejar juntas de dilatación (5-7 mm. por cada 7 metros)

8.- Al tratarse de un material natural, se advierte que los acabados en rechapados de madera natural barnizada, no así los acabados en melaminas con tonalidades de madera, pueden presentar variaciones de tonalidad entre placas.

9.- Los acabados en melaminas con tonalidades y/o imitaciones con terminaciones metálicas (ej. melamina inox) podrán presentar algunas variaciones de tonalidad entre placas debido a la incidencia y reflexión de luz. Así mismo, en los pedidos realizados con MDF ignífugo se pueden presentar soportes con cierta tonalidad roja que puede apreciarse, en mayor o menor medida, según el tipo de perforación y/o modelo suministrado.

10.- En la colocación con sistema de perfilera oculta (no así en otros sistemas de montaje), y debido a los movimientos físicos-mecánicos propios de la madera pueden aparecer "cejas" entre placa y placa. En estos casos se recomienda que ante dicha situación, la solución sea calzar las placas que produzcan estos defectos visuales.

11.- La limpieza se realizará con un paño ligeramente humedecido sin utilizar nunca productos abrasivos o que contengan siliconas.

1.- The material should be unpacked immediately before installation. In order to an environmental appropriate adaptation of panels, it is recommended to keep them on site where they will be installed between 24/48 hours previously for acclimatization purposes.

2.- The original packaging does not protect the material from rain, humidity, impacts, among others. No load should be placed on the material.

3.- The places shall be covered unless the material is adapted to it and agreed that possibility.

4.- The environment should not be with humidity above 60%.

5.- Items such as open windows, heating, air conditioning, among others affect the material may cause the plates to contract and / or dilate if temperatures are not stable. These effects of the material and their falls, separations, among others are not the responsibility of the manufacturer.

6.- Tolerances on dimensions per plate may vary by +/- 0.4% in both length and width according to manufacturer's support used.

7.- As a material derived from wood, it is recommended to leave an expansion joint (5-7 mm each 7 meters).

8.- Being a natural material, it is noted that varnished natural wood veneers, not melamine with wood tones, they may present variations in shade between plates.

9.- The melamine finish with shades and / or imitations with metallic finishes (Eg stainless melamine) may present some variations in tone between plates due to the incidence and reflection of light. Fire-retardant and moisture-resistant supports can show red and green tonalities due to the components used to lend these characteristics to the supports.

10.- In concealed form (but not in other mounting systems), and because the physical-mechanical own timber movements may be submitted "tab" plate to plate. In these cases, the solution is to fit the plates that produce these visual defects.

11.-Cleaning should be carried out with a damp cloth. Never use abrasive or silicon-based products.



## Curvatura de paneles Curvature of panels

Todos los modelos Spigoacoustic tienen la posibilidad de instalarse sobre diferentes superficies curvas. Con un radio mínimo de 4 metros, nuestro departamento técnico puede ofrecerle un amplio rango de curvaturas y distintas formas, ya sean cóncavas, convexas u onduladas. Esto garantiza una gran libertad y creatividad a técnicos y arquitectos en la puesta en obra de sus diseños.

All Spigoacoustic models have the possibility to install on curved different surfaces. Our Technical Department can offer you a wide range of curves and different shapes (concave, convex or wavy) with a minimum radio of 4 meters. This guarantees a considerable freedom and creativity to technics and architects when they are making the design of their projects.

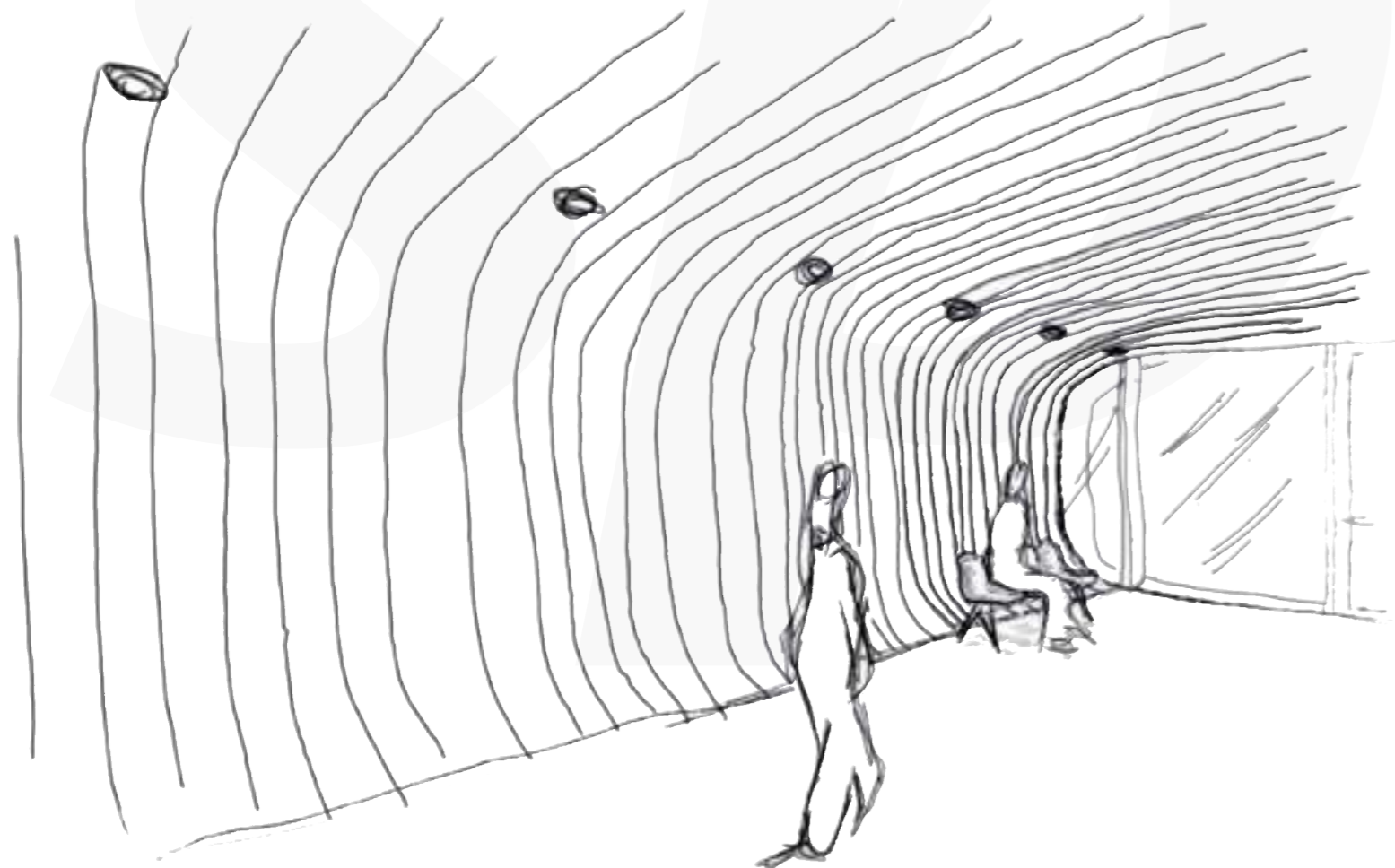

## Áreas de aplicación Application areas



### Centros de enseñanza

Aulas  
Colegios  
Guarderías  
Universidades  
Academias



### Usos múltiples

Salas de conferencias  
Auditorios  
Bibliotecas



### Aeropuertos



### Estudios de radio y TV



### Iglesias



### Edificios públicos

### Educational Establishments

Rooms  
Schools  
Nurseries  
Universities  
Academies

### Multiple applications

Conference rooms  
Auditoriums  
Libraries

### Airports

### Radio & TV Studio

### Churches

### Public buildings



### Restauración

Bares  
Restaurantes  
Hoteles



### Salud

Hospitales  
Centros de salud



### Centros de ocio

Cines  
Centros comerciales  
Centros culturales  
Teatros  
Salas de conciertos  
Ludotecas

### Restoration

Bars  
Restaurants  
Hotels

### Health

Hospitals  
Health centres

### Leisure Centre

Cinemas  
Shopping centres  
Cultural centres  
Theatres  
Concert halls  
Play centre

# Prescripción Prescription

Elegir **Spigoacustic** representa tener la garantía de una calidad de servicio irreprochable. Profesionalidad, conocimientos técnicos y escucha para resolver lo mejor posible cualquier consulta constituyen nuestros principios fundamentales.

Pero elegir **Spigoacustic** también significa beneficiarse de las numerosas ventajas de una firma con personalidad única e importante reputación:

- Todos nuestros paneles combinan diseño y funcionalidad que contribuyen a crear mejores condiciones y crear buenos ambientes interiores.
- 📦 Las características y el embalaje de todos nuestros productos ofrece las mejores condiciones para el transporte, la manipulación y el almacenamiento.
- 📐 Las medidas de los paneles acústicos y de sus perfiles son estándar de manera que no sólo facilita el montaje sino que también la homogeneidad visual de la superficie resulta impecable.
- 🏆 Están de conformidad con todas las certificaciones y normas vigentes que avalan la calidad de nuestros productos.
- 👍 Cuentan con la mejor relación calidad-precio en un plazo inmejorable. Los acabados son perfectos y el resultado es impecable.

Para facilitar la elaboración de proyectos y la selección de nuestra gama de paneles acústicos **Spigoacustic**, ponemos a disposición de nuestros clientes la siguiente herramienta que apoyará su decisión de prescribir Spigogroup. Les permitirá localizar fácilmente la información que desean e incorporarla a sus presupuestos y planos.



ACCESO A PRESTO ACCESS TO PRESTO

**Presto**



- Información técnica Technical info.
- Planos Drawings
- Medidas Sizes
- Modelos Models
- Características Characteristics

Choosing **Spigoacustic** means to have the guarantee of an irreproachable quality service. Professionalism, technical knowledges and listening to solve in the best way any request are our main principles.

But choosing **Spigoacustic** also means to benefit from the advantages of a firm with unique personality and considerable reputation:

- All our panels combine design and functionality and contribute to create better acoustic conditions and good interior environments.
- 📦 The characteristics and packaging of all our products offer the best conditions for the transport, manipulation and storage.
- 📐 The dimensions of panels are standard. Not only does it facilitate the assembly but also the visual homogeneity seems impeccable.
- 🏆 Spigoacustic panels accomplish all the certifications, homologations and existing rules which guarantee the quality of our products.
- 👍 Spigoacustic panels count on the price-quality ratio in an unbeatable deadline. The finishes are perfect and the result incredible.

To facilitate the elaboration of projects and the selection of our range of acoustic **Spigoacustic** products, Spigogroup put at customers' disposal the following tool which support with their decision to prescribe Spigogroup.

## EJEMPLO TEXTO MEMORIA PROYECTO EXAMPLE TEXT MEMORY PROJECT

*Revestimiento con paneles de la marca SPIGOACUSTIC, modelo 20-16-32, acabado en Melamina sobre soporte M.D.F. ignífugo M-1/B-s2,d0 de 16 mm. de espesor, con mecanizado perimetral de los lados machihembrados para colocar con sistema de Perfil Omega + grapa, medidas de placas 1200x300 mm. ó 2400x300 mm. (288 mm. de anchura real) y velo negro fonoabsorbente termoadherido al dorso de las placas. % perforación 3,29, NRC 0,60 y coef. de absorción 0,470.*

*Wood wall covering o false ceiling of the brand SPIGOACUSTIC, model 20-16-32, finish melamine on support fire-retardant mdf m1/b-s2,d0 of 16 mm thickness, with male-female joint, through the collocation system omega form + iron clamp and panel dimensions 1200x300 mm or 2400x300 mm (real 288 mm) and with acoustic black veil 3,29% perforation, nrc 0,60 and absorption coefficient 0,470"*



# Certificados Certificates

En la calidad final de un espacio constructivo también influye la gestión de la calidad en los procesos de producción. Por ello, Spigogroup desarrolla todos sus productos atendiendo a unos niveles de calidad que garanticen fiabilidad y confianza en todos sus proyectos.

Más de 30 años trabajando la madera han llevado a Spigogroup a respetarla, admirarla y ser conscientes de la importancia de establecer políticas para preservarla. Por ello, un excelente departamento de calidad dedicado a la mejora continua empresarial, avala su compromiso con el medio ambiente, el desarrollo sostenible de su actividad y su buena gestión empresarial como parte de la excelencia de sus productos y servicios.

The quality management in the production process influences in the final quality of a construction space. Therefore, Spigogroup develops its products to attend some standard of quality wich guarantee reliability and conficence into all projects.

Spigogroup has been working with wood over 30 years. Therefore, it has led us to admire and respect and be aware of the importance to stablish politics to preserve it. For this reason, an excellent Quality Department dedicated to the continuous business improvement, guarantees the commitment with the environment, sustainable development of its activity and its good business management like a part of excellence of its products and services.

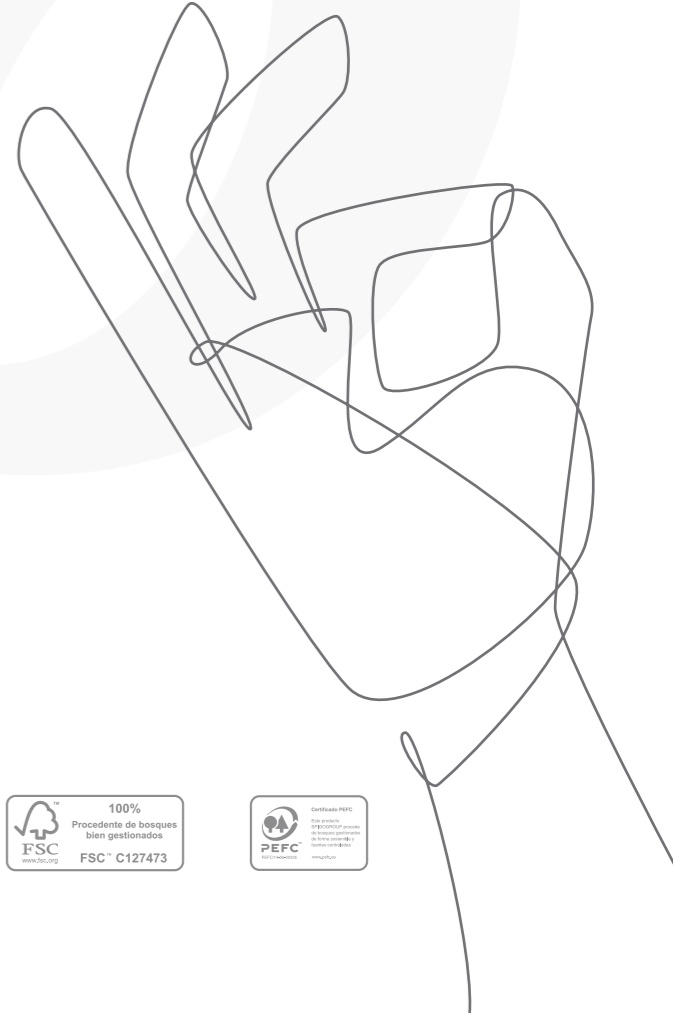



**spigo GROUP**<sup>®</sup>  
PROYECTOS EN MADERA

Polígono Industrial Cantabria II  
Calle Las Cañas 19  
26009 Logroño. La Rioja, Spain  
t. +34 941 244 777  
f. +34 941 261 580  
comercial@spigogroup.com  
export@spigogroup.com  
www.spigogroup.com

