

Modelo | Model

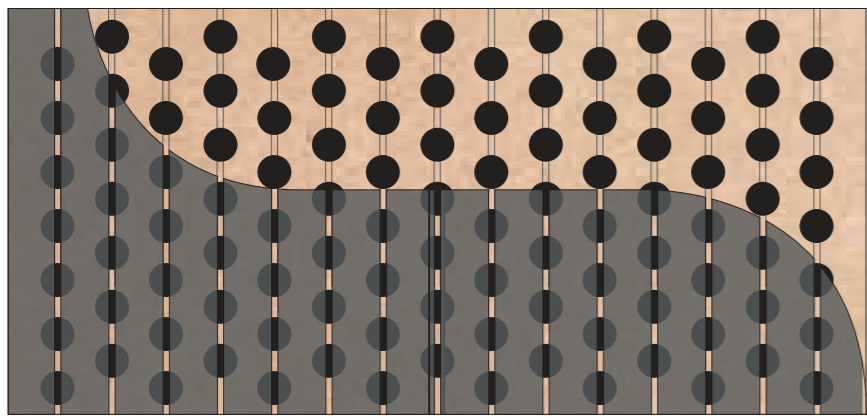

Canal | Groove width: 2 mm.
Distancia taladros | Backside perforation spacing: 16 mm
Distancia canales | Groove spacing: 16 mm

Acabados | Finishes

Melamina Melamine
Espesor | Thickness 16 mm.
Densidad | Density 14 Kg/m.

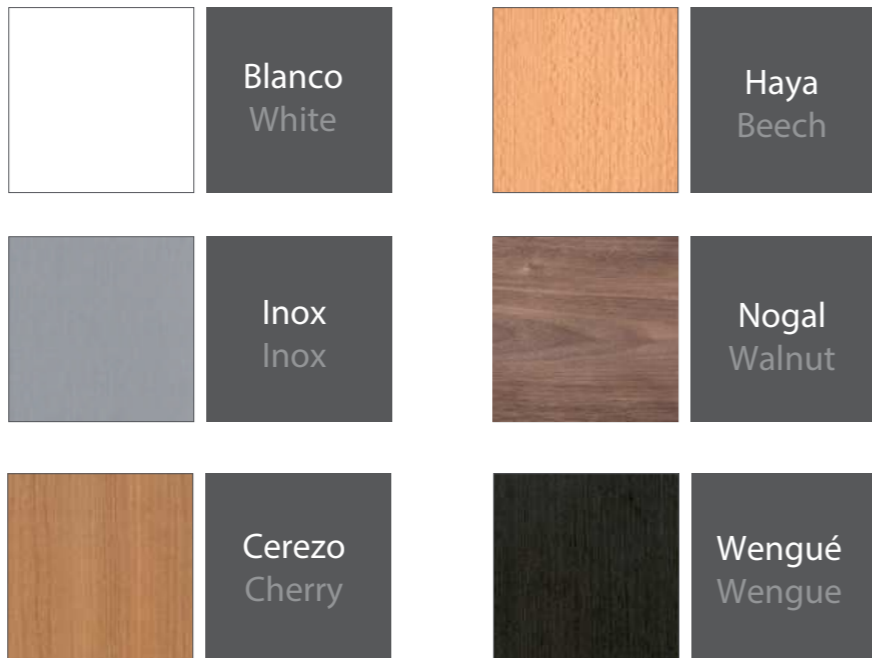

Madera natural Natural wood veneer

Espesor | Thickness 16 mm.
Densidad | Density 14 Kg/m.

Haya, Roble, Male, Cerezo etc.
Beech, Oak, Maple, Cherry ...

Lacado Lacquered

Espesor | Thickness 16 mm.
Densidad | Density 14 Kg/m.

Disponibles en cualquier referencia de las cartas RAL, Pantone o NCS

Available in any shade from RAL, Pantone or NCS color charts.

HPL High pressure laminate

Espesor | Thickness 16 mm.
Densidad | Density 14 Kg/m.

Aplacados de laminados de alta densidad con altas prestaciones

Available in high density laminate (HPL) facing.

Absorción acústica | Acoustic absorption

$\alpha_w = 0,80$ % perf. = 7%



NRC 0,85 | SAA 0,83

*Datos estimados según norma UNE ISO 354, ponderados según norma UNE ISO 11654
*Data estimated as per ISO 354 standard, weighed as per ISO 11654 standard

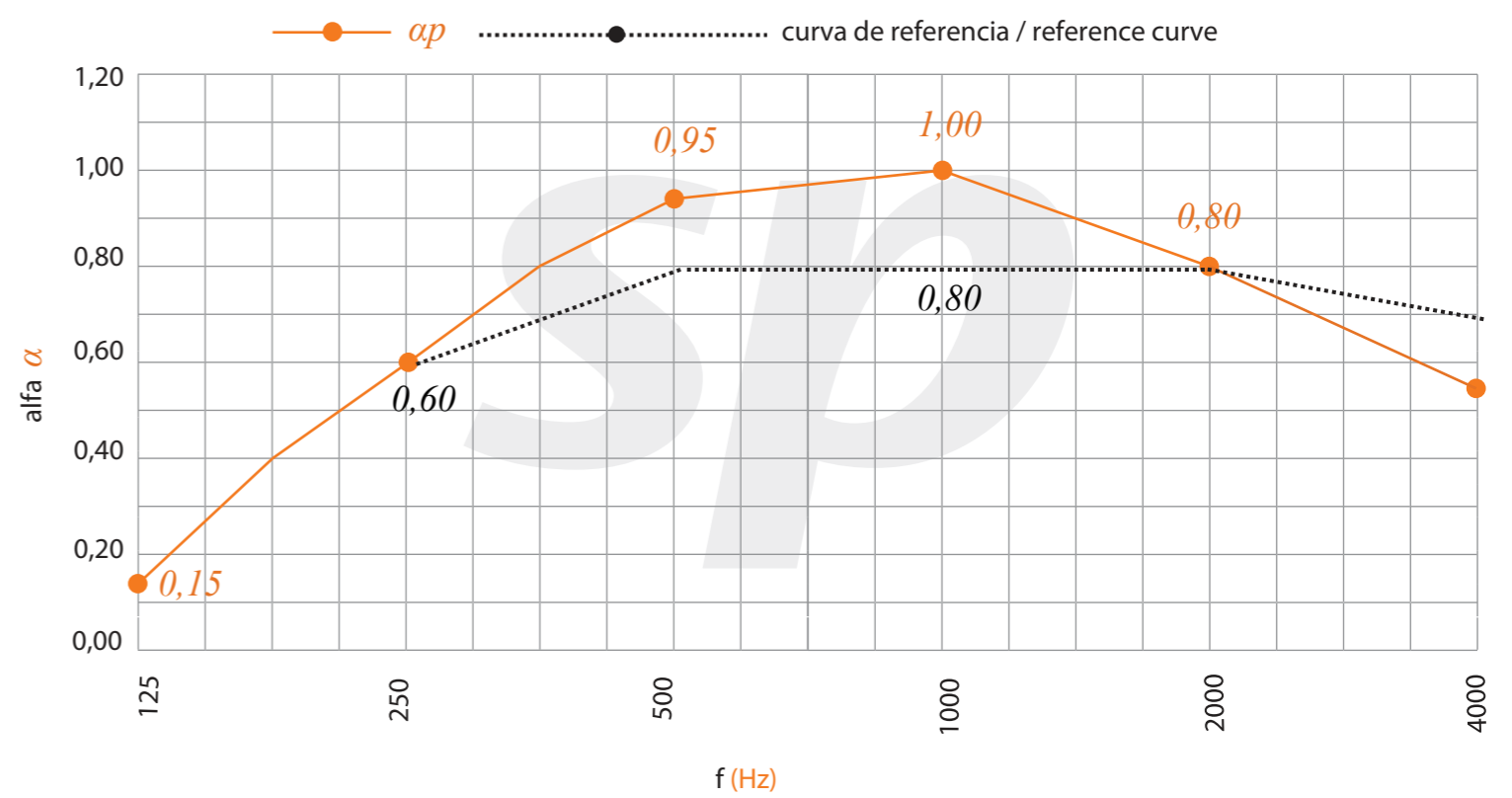

Sistema de instalación | Installation system

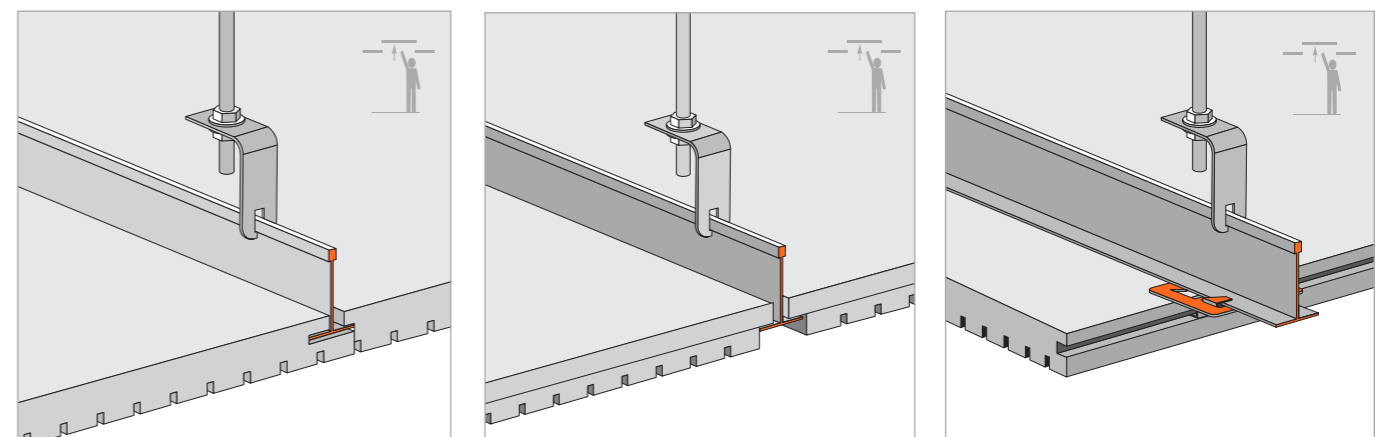

PERFIL OCULTO T-15
T-15 (9/16") concealed grid

PERFIL SEMIVISTO T-15/T-24
T-15 (9/16") or T-24 (15/16") semi-exposed grid

PERFIL OCULTO T-24 + GRAPA
T-24 (15/16") concealed grid + cramp

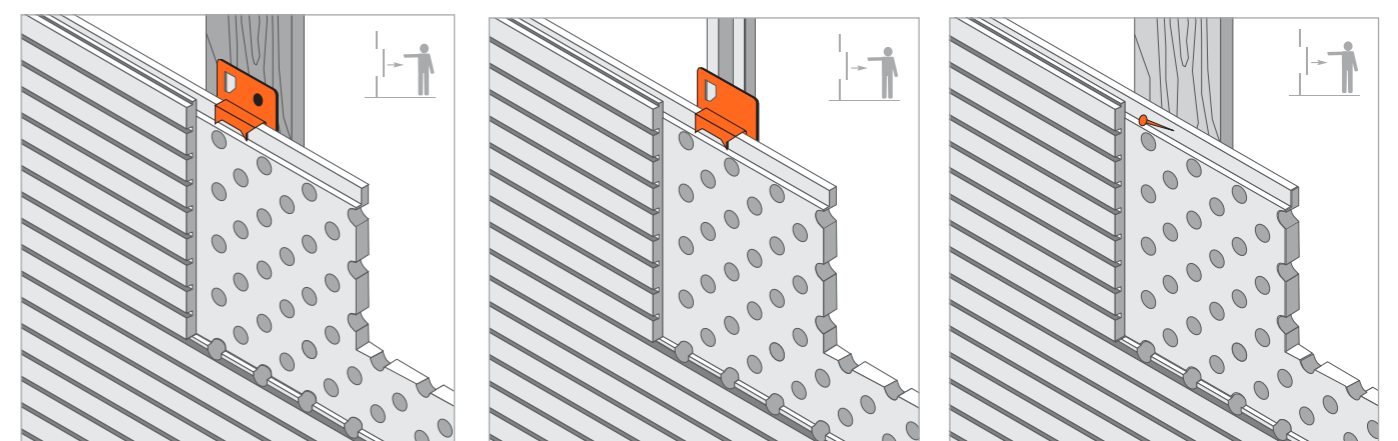

RASTREL MADERA + GRAPA
WOODEN STRIP + CRAMP

PERFIL OMEGA + GRAPA
OMEGA PROFILE + CRAMP

RASTREL MADERA
WOODEN STRIP



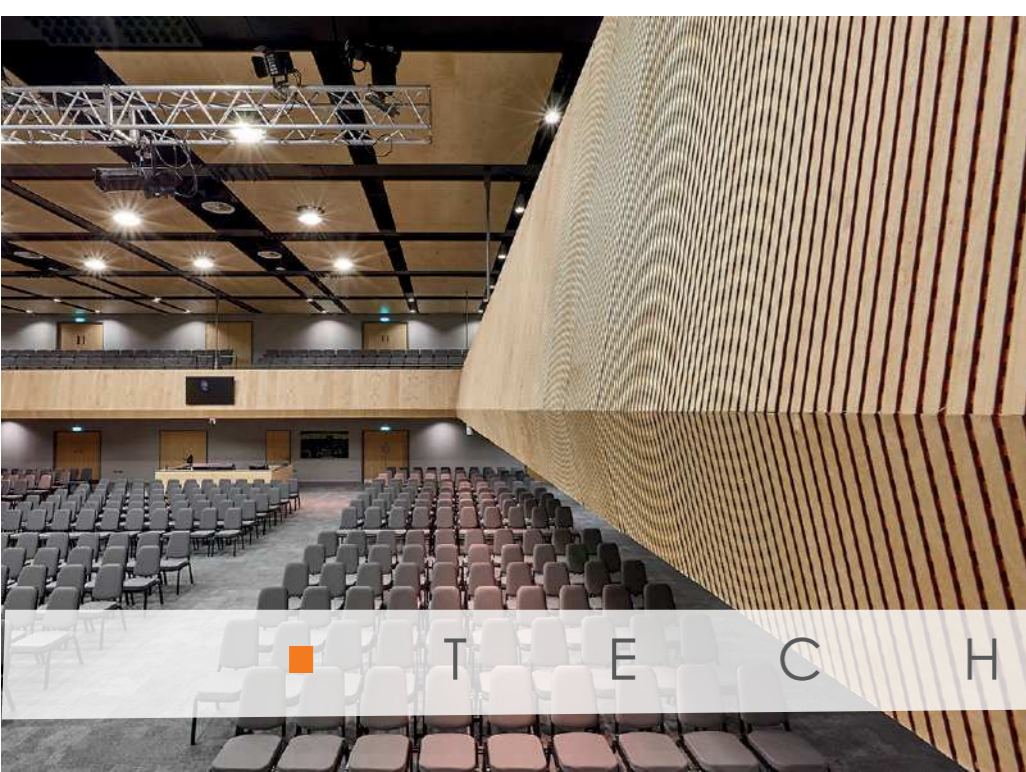

Medidas | Panel dimensions

TECHOS CEILINGS	MEDIDAS COMERCIALES COMMERCIAL SIZES	MEDIDAS REALES REAL SIZES
PERFIL OCULTO T-15 T-15 (9/16") concealed grid	1200x300 mm	1200x288 mm
PERFIL SEMIVISTO T-15/T-24 T-15 (9/16") or T-24 (15/16") semi-exposed grid	1200x300 mm 1200x600 mm 600x600 mm	1194x294 mm 1194x594 mm 594x594 mm
PERFIL OCULTO T-24 + GRAPA T-24 (15/16") concealed grid + cramp	1200x300 mm 2400x300 mm	1200x288 mm 2400x288 mm

PAREDES WALLS	MEDIDAS COMERCIALES COMMERCIAL SIZES	MEDIDAS REALES REAL SIZES
PERFIL OMEGA + GRAPA OMEGA FORM + FIXING CRAMP	1200x300 mm 2400x300 mm	1200x288 mm 2400x288 mm
RASTREL DE MADERA + GRAPA WOODEN STRIP + CRAMP		
RASTREL DE MADERA WOODEN STRIP		

Soportes | Board core options

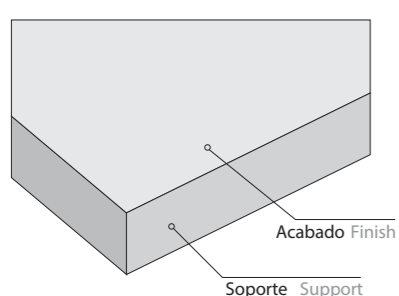

- MDF ESTÁNDAR** STANDARD MDF
- MDF IGNÍFUGO** FIRE-RETARDANT MDF
- MDF HIDRÓFUGO** MOISTURE-RESISTANT MDF

Aplicaciones especiales | Non-standard applications

Todos los modelos Spigoacoustic permiten la posibilidad de instalarse sobre superficies curvas y/o inclinadas.
All Spigoacoustic models allow for installation on curved or sloped surfaces.

*Radio mínimo 2 m para curvatura.
*Minimum curvature radius 2 m.

*Deben preverse rastreles de madera cada 200 mm máximo de distancia y el único método posible de instalaciones el claveteado sobre rastrel. Pueden emplearse opcionalmente grapas.

*For installation on sloped surfaces, installation shall be performed by nailing the panels on wooden battens placed at 200 mm spacing. Fixing cramps are optional.

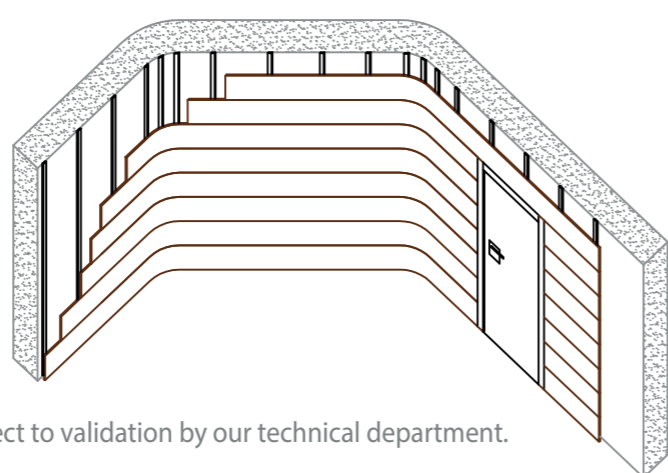

*Requiere validación de nuestro departamento técnico. Subject to validation by our technical department.

Complementos | Complements

