

Modelo | Model

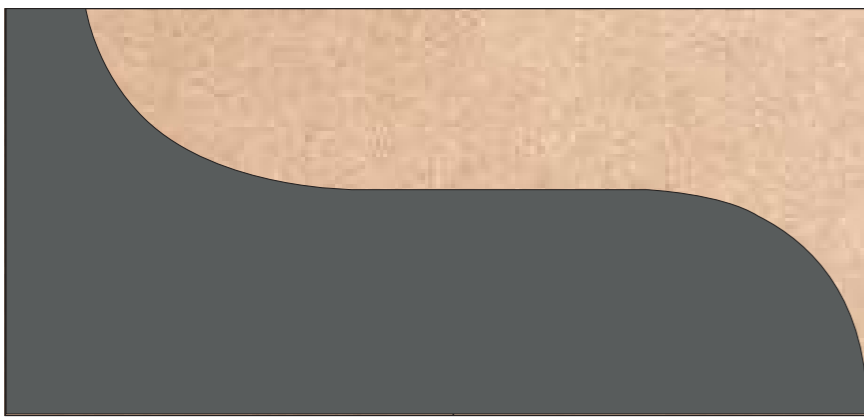

Canal | Groove width: -  
Distancia taladros | Backside perforation spacing: -  
Distancia canales | Groove spacing: -

Acabados | Finishes

Melamina Melamine  
Espesor | Thickness 16 mm.  
Densidad | Density 14 Kg/m.

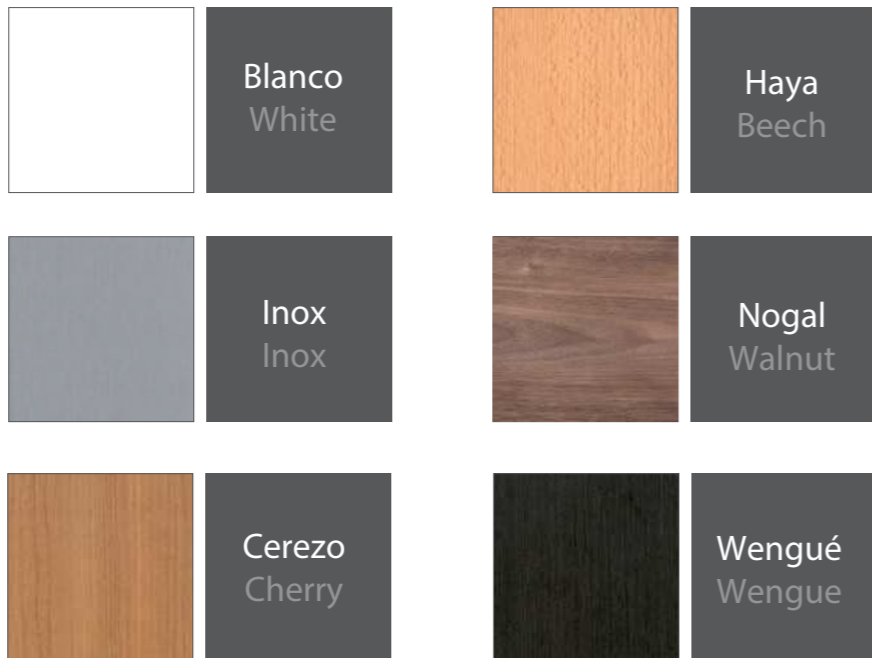

Madera natural Natural wood veneer

Espesor | Thickness 16 mm.  
Densidad | Density 14 Kg/m.

Haya, Roble, Male, Cerezo etc.  
Beech, Oak, Maple, Cherry ...

Lacado Lacquered

Espesor | Thickness 16 mm.  
Densidad | Density 14 Kg/m.

Disponibles en cualquier referencia de las cartas RAL, Pantone o NCS

Available in any shade from RAL, Pantone or NCS color charts.

HPL High pressure laminate

Espesor | Thickness 16 mm.  
Densidad | Density 14 Kg/m.

Aplacados de laminados de alta densidad con altas prestaciones

Available in high density laminate (HPL) facing.

Absorción acústica | Acoustic absorption

$\alpha_w = 0,070$  % perf. = 0%



NRC 0,05 |

\*Datos estimados según norma UNE ISO 354, ponderados según norma UNE ISO 11654  
\*Data estimated as per ISO 354 standard, weighed as per ISO 11654 standard

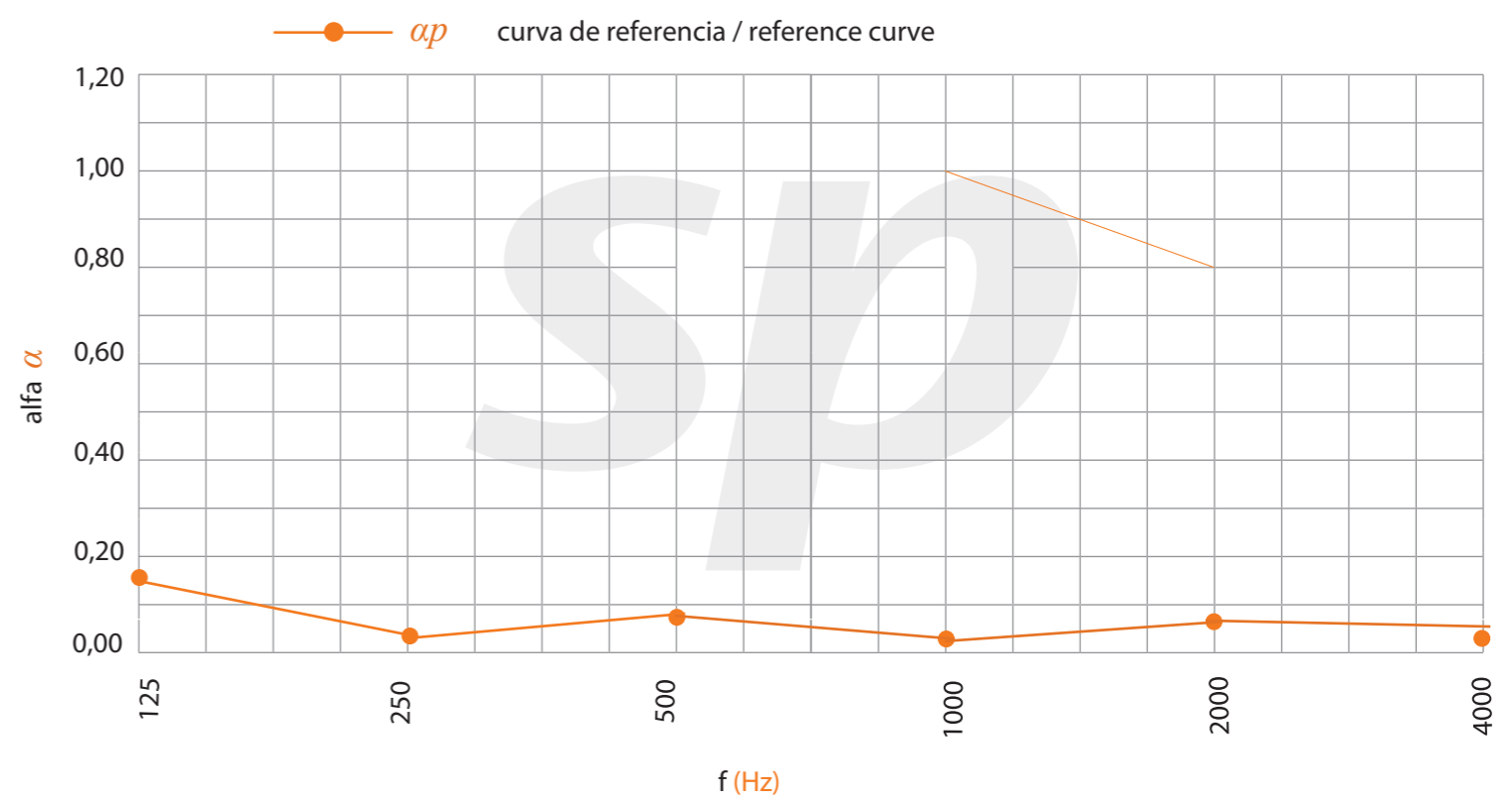

Sistema de instalación | Installation system

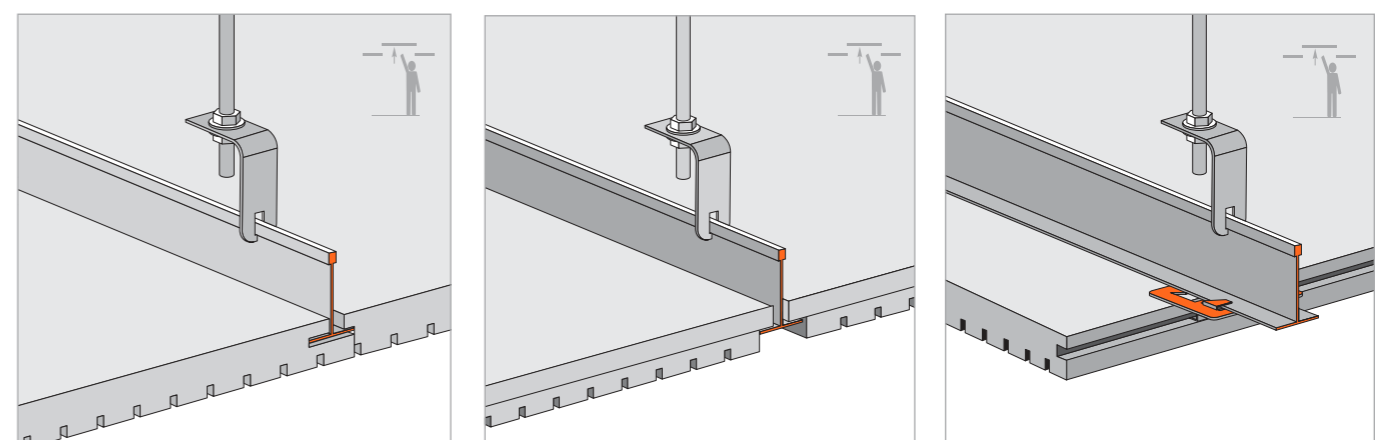

PERFIL OCULTO T-15 T-15 (9/16") concealed grid  
PERFIL SEMIVISTO T-15/T-24 T-15 (9/16") or T-24 (15/16") semi-exposed grid  
PERFIL OCULTO T-24 + GRAPA T-24 (15/16") concealed grid + cramp

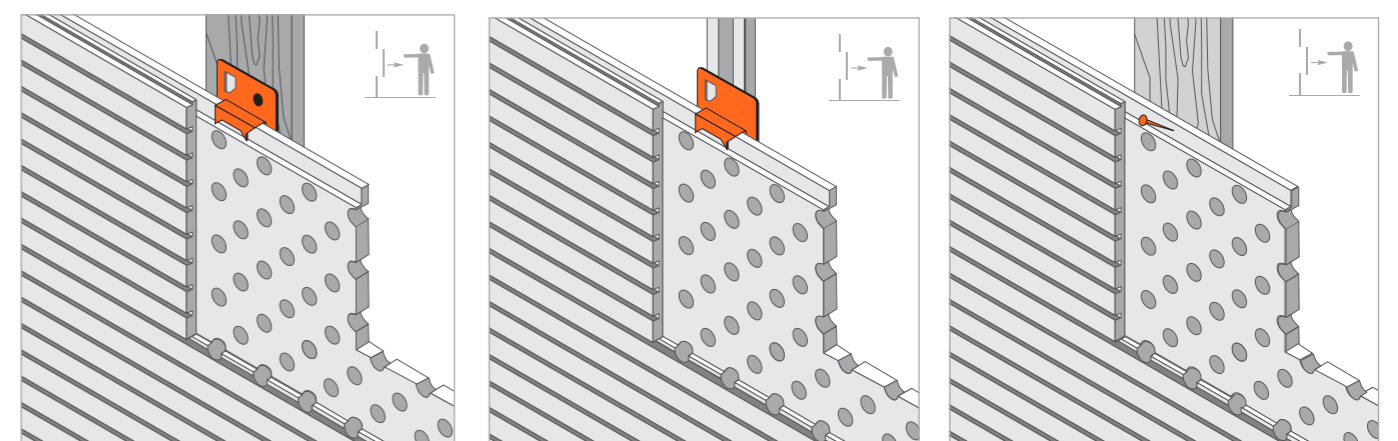

RASTREL MADERA + GRAPA WOODEN STRIP + CRAMP  
PERFIL OMEGA + GRAPA OMEGA PROFILE + CRAMP  
RASTREL MADERA WOODEN STRIP



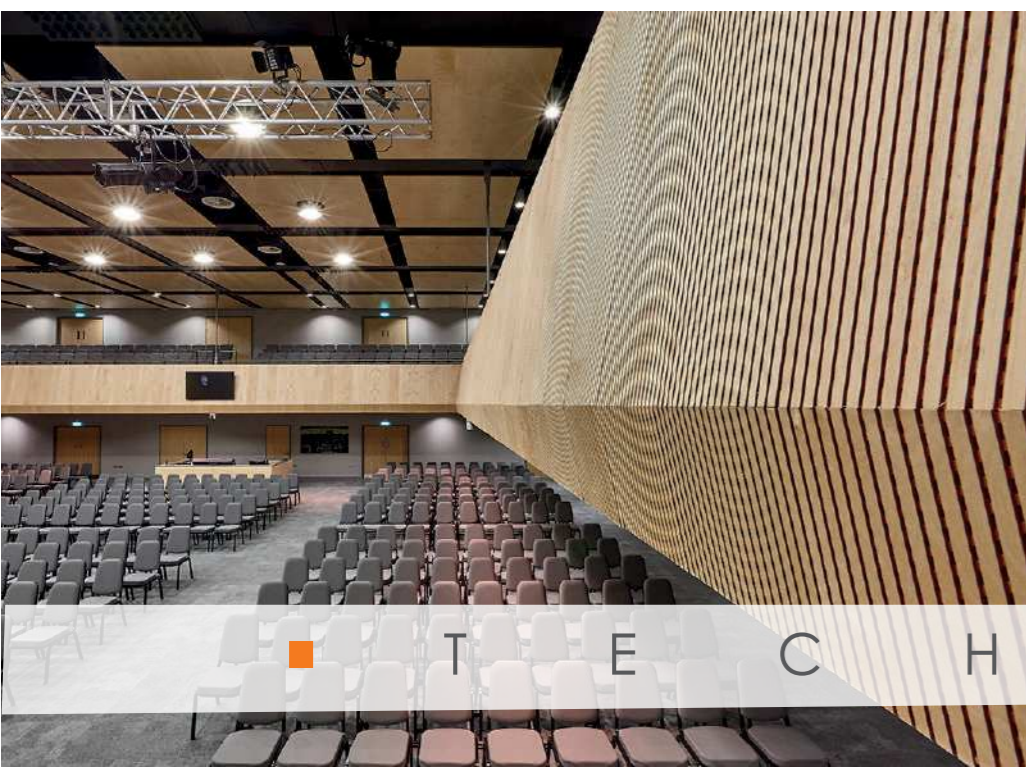

## Medidas | Panel dimensions

TECHOS CEILINGS	MEDIDAS COMERCIALES COMMERCIAL SIZES	MEDIDAS REALES REAL SIZES
PERFIL OCULTO T-15 T-15 (9/16") concealed grid	1200x300 mm	1200x288 / 1200x256 mm
PERFIL SEMIVISTO T-15/T-24 T-15 (9/16") or T-24 (15/16") semi-exposed grid	1200x300 mm 1200x600 mm 600x600 mm	1194x294 mm 1194x594 mm 594x594 mm
PERFIL OCULTO T-24 + GRAPA T-24 (15/16") concealed grid + cramp	1200x300 mm 2400x300 mm	1200x288 / 1200x256 mm 2400x288 / 2400x256 mm

PAREDES WALLS	MEDIDAS COMERCIALES COMMERCIAL SIZES	MEDIDAS REALES REAL SIZES
PERFIL OMEGA + GRAPA OMEGA FORM + FIXING CRAMP	1200x300 mm 2400x300 mm	1200x288 / 1200x256 mm 2400x288 / 2400x256 mm
RASTREL DE MADERA + GRAPA WOODEN STRIP + CRAMP		
RASTREL DE MADERA WOODEN STRIP	1200x600 mm 2400x600 mm	1200x576 mm 2400x576 mm

## Detalle | Detail

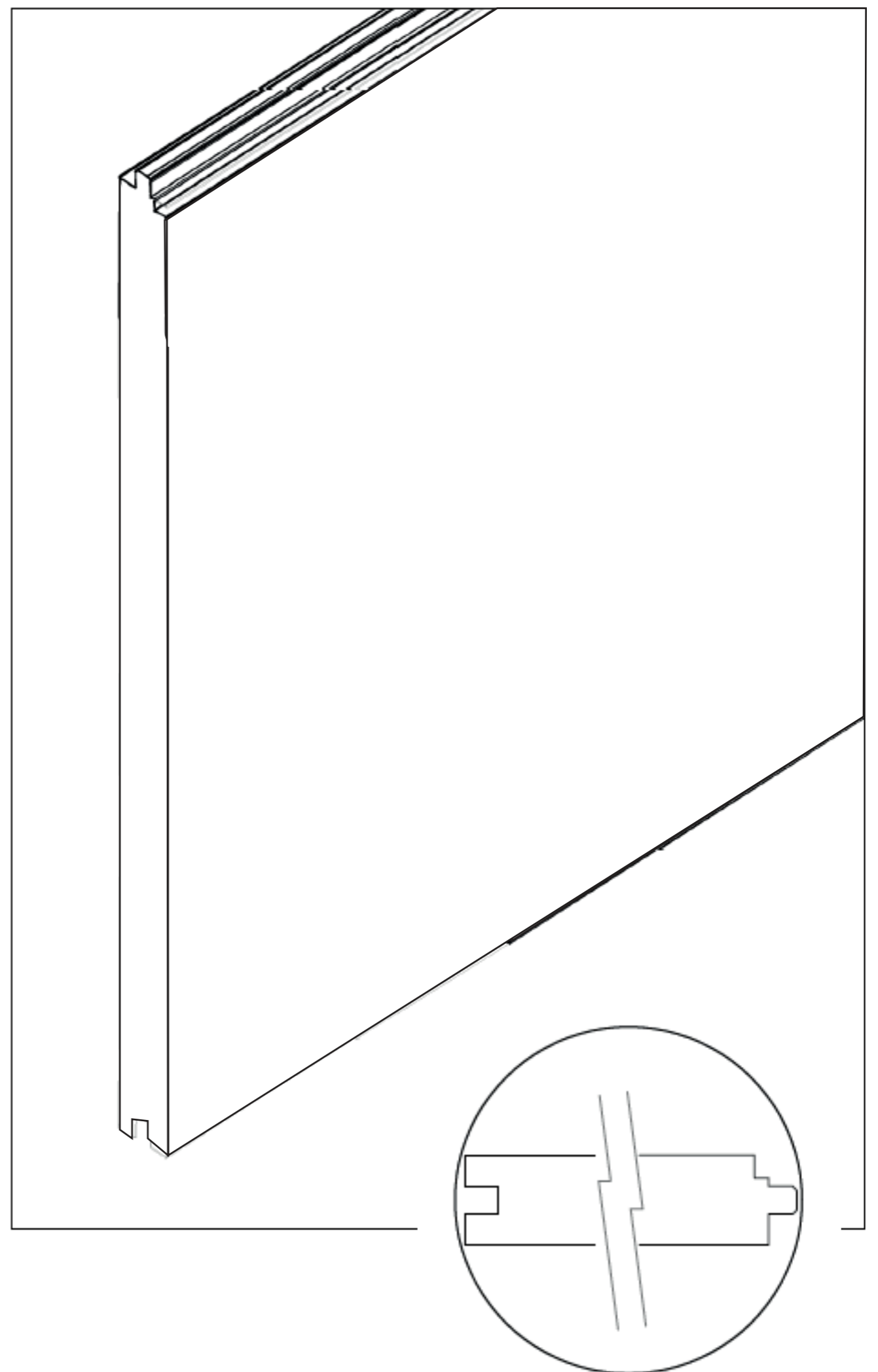

## Soportes | Board core options

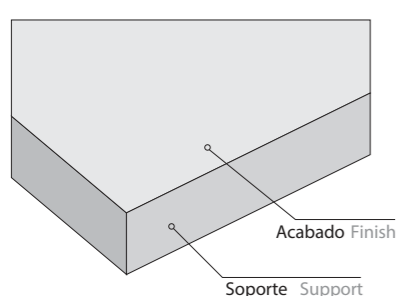

-  MDF ESTÁNDAR STANDARD MDF
-  MDF IGNÍFUGO FIRE-RETARDANT MDF
-  MDF HIDRÓFUGO MOISTURE-RESISTANT MDF

## Aplicaciones especiales | Non-standard applications

Todos los modelos Spigoacoustic permiten la posibilidad de instalarse sobre superficies curvas y/o inclinadas.  
All Spigoacoustic models allow for installation on curved or sloped surfaces.

\*Radio mínimo 2 m para curvatura.  
\*Minimum curvature radius 2 m.

\*Deben preverse rastreles de madera cada 200 mm máximo de distancia y el único método posible de instalaciones el claveteado sobre rastrel. Pueden emplearse opcionalmente grapas.

\*For installation on sloped surfaces, installation shall be performed by nailing the panels on wooden battens placed at 200 mm spacing. Fixing cramps are optional.

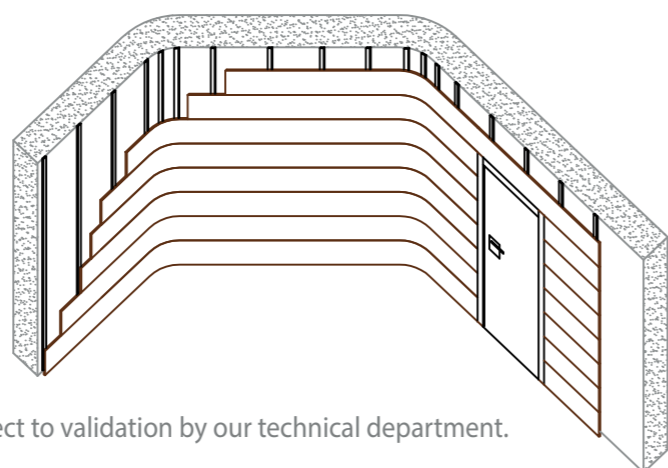

\*Requiere validación de nuestro departamento técnico. Subject to validation by our technical department.

## Complementos | Complements

