

MMU-UP_WH CASSETTE DE 2 VÍAS



Compacto, ligero y de baja silueta, el cassette de 2 vías ha sido diseñado para encajar fácil y discretamente en el interior de cualquier estancia.

CAPACIDAD



0,8HP < 6HP

NIVEL DE PRESIÓN SONORA



30dB(A)

UNIDADES EXTERIORES COMPATIBLES



SMMS-e baja carga de refrigerante & MINI SMMS-e



SMMS-u



SMMS-e



SHRM-e

CONTROLES LOCALES



RBC-AXU31-E



RBC-ASCU11-E
RBC-AMTU31-E
RBC-AMSU51-EN/ES

CARACTERÍSTICAS

Nombre del modelo	MMU-UP0071WH-E	UP0091WH-E	UP0121WH-E	UP0151WH-E	UP0181WH-E	UP0241WH-E	UP0271WH-E	UP0301WH-E	UP0361WH-E	UP0481WH-E	UP0561WH-E							
Código de capacidad	HP	0,8	1	1,3	1,7	2	2,5	3	3,2	4	5	6						
Capacidad de refrigeración	kW	2,2	2,8	3,6	4,5	5,6	7,1	8,0	9,0	11,2	14,0	16,0						
Capacidad de calefacción	kW	2,5	3,2	4,0	5,0	6,3	8,0	9,0	10,0	12,5	16,0	18,0						
Característ. eléctricas	Alimentación	Monofásica 50Hz 220-240V / Monofásica 60Hz 220V (Se requiere alimentación separada para las unidades interiores.)																
	Corriente funcionam.	50 Hz	A	0,23	0,23	0,23	0,24	0,32	0,39	0,39	0,46	0,48	0,57	0,75				
	Consumo de energía A/B	kW	0,029 / 0,026	0,029 / 0,026	0,029 / 0,026	0,03 / 0,026	0,044 / 0,037	0,054 / 0,045	0,054 / 0,045	0,064 / 0,062	0,073 / 0,60	0,088 / 0,07	0,117 / 0,089					
	Corriente de arranque	A	0,35	0,35	0,35	0,36	0,48	0,59	0,59	0,69	0,72	0,86	1,13					
Apariencia	Unidad principal	Material de aislamiento térmico unido a placa de acero galvanizado por inmersión en caliente en baño de cinc																
	Panel de techo	Modelo	RBC-UW283PG(W)-E					RBC-UW803PG(W)-E			RBC-UW1403PG(W)-E							
	Color del panel	Blanco luna_(Munsell 2.5GY9.0/0.5)																
Dimensiones exteriores	Unidad principal	Alt.xAn.xP	mm					295x815x570			345x1180x570			345x1600x570				
	Panel de techo	Alt.xAn.xP	mm					20x1050x680			20x1415x680			20x1835x680				
Peso total	Unidad principal	kg	19	19	19	19	26	26	26	26	36	36	36					
	Panel de techo	kg	10	10	10	10	10	14	14	14	14	14	14					
Intercambiador de calor	Tubos aleteados																	
Material de aislamiento térmico / acústico	Aislamiento no inflamable																	
Unidad del ventilador	Ventilador	Turbo																
	Caudal de aire estándar (Alto/Medio/Bajo)	m³/h	558 / 498 / 450			600/534/ 450		900/750/ 618		1050 /840 / 738		1260/900/ 780		1740/1434/ 1182		1800/1482/ 1230		2040/1578/ 1320
Potencia del motor	W	20					30			40		50		70				
Nivel de presión sonora (Alto/Medio/Bajo)	dB(A)	34 / 32 / 30			35 / 33 / 30		38 / 35 / 33		40/37/34		42/39/36		43/40/37		46/42/39			
Nivel de potencia sonora (Alto)	dB(A)	34 / 32 / 30			35 / 33 / 30		38 / 35 / 33		40/37/34		42/39/36		43/40/37		46/42/39			
Filtro de aire	Filtro estándar (filtro de larga duración)																	
Control	Control remoto por cable o infrarrojos																	
Tubería de conexión	Tubería de gas	pulg.	3/8"	3/8"	3/8"	1/2"	1/2"	5/8"	5/8"	5/8"	5/8"	5/8"	5/8"					
	Tubería de líquido	pulg.	1/4"	1/4"	1/4"	1/4"	1/4"	3/8"	3/8"	3/8"	3/8"	3/8"	3/8"					
	Puerto de drenaje (diámetro nominal)	mm	25 (Tubo de cloruro de polivinilo)															

ESQUEMÁTICOS

MMU-UP0071WH-E a MMU-UP0151WH-E

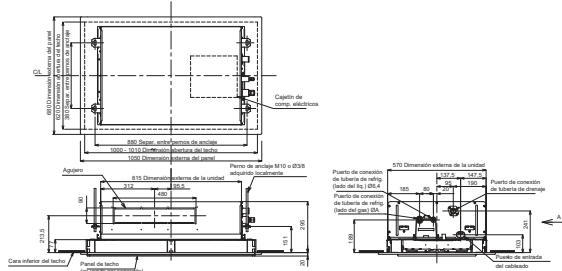

MMU-UP0181WH-E a MMU-UP0301WH-E

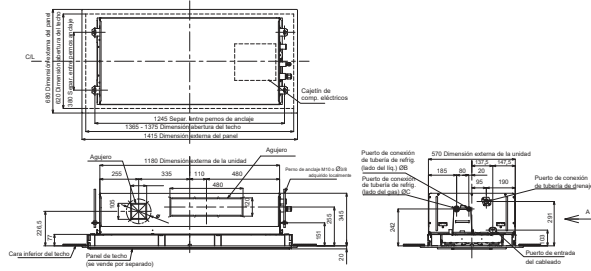

MMU-UP0361WH-E a MMU-UP0561WH-E

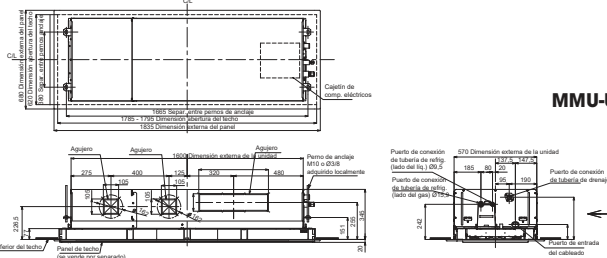

Unidad: mm

CASSETTE DE 2 VÍAS

NIVELES DE PRESIÓN SONORA

Unidad: dB(A)

MMU-UP0071WH-E, UP0091WH-E, UP0121WH-E

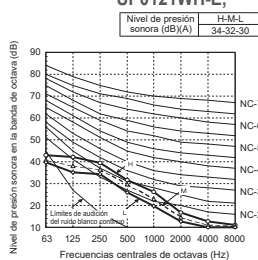

MMU-UP0151WH-E

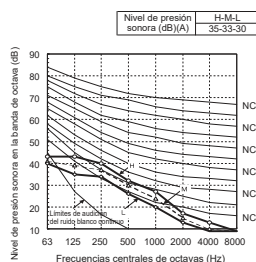

MMU-UP0181WH-E

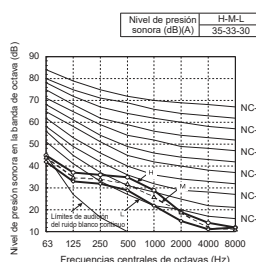

MMU-UP0241WH-E, UP0271WH-E

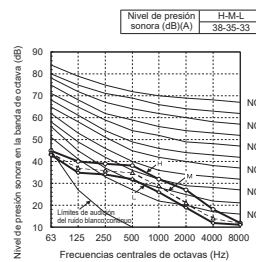

MMU-UP0301WH-E

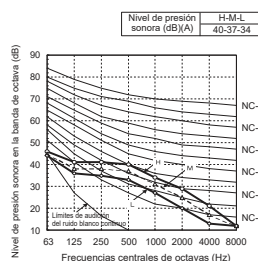

MMU-UP0361WH-E

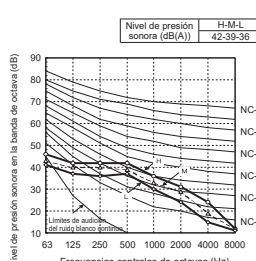

MMU-UP0481WH-E

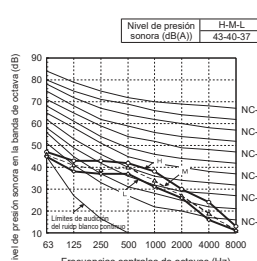

MMU-UP0561WH-E

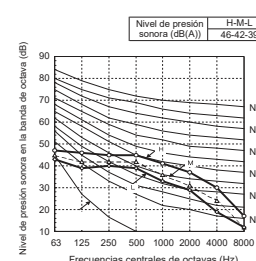

DIFUSIÓN DE AIRE

Unidad: m/s

MMU-UP0071WH-E, UP0091WH-E, UP0121WH-E, UP0151WH-E

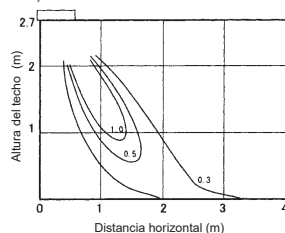

MMU-UP0181WH-E

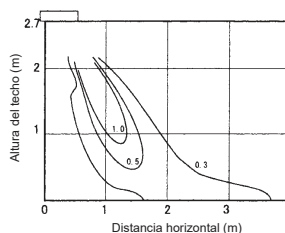

MMU-UP0241WH-E, UP0271WH-E

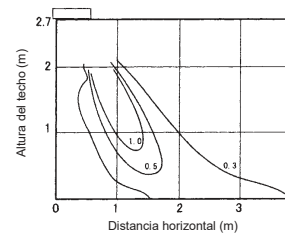

MMU-UP0301WH-E

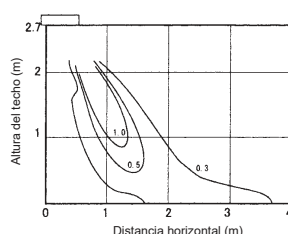

MMU-UP0361WH-E, MMU-UP0481WH-E

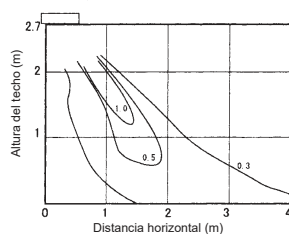

MMU-UP0561WH-E

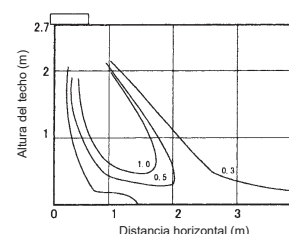

ACCESORIOS

Nº	Componente	Nombre del modelo	Modelo aplicado	Notas	Observaciones
1	Panel de techo	RBC-UW283PG(W)-E	MMU-UP0071 a 0151WH	Accesorio necesario	
		RBC-UW803PG(W)-E	MMU-UP0181 a 0301WH		
		RBC-UW1403PG(W)-E	MMU-UP0361 a 0561WH		
2	Filtro de super larga duración	TBC-LF283UW-E	MMU-UP0071 a 0151WH	Efecto de captación de polvo: 50% (método basado en el peso)	Usar con TBC-FC283UW-E
		TBC-LF803UW-E	MMU-UP0181 a 0301WH		Usar con TBC-FC803UW-E
		TBC-LF1403UW-E	MMU-UP0361 a 0561WH		Usar con TBC-FC1403UW-E
3	Cámara de filtro	TBC-FC283UW-E	MMU-UP0071 a 0151WH	Para filtro de super larga duración	
		TBC-FC803UW-E	MMU-UP0181 a 0301WH		
		TBC-FC1403UW-E	MMU-UP0361 a 0561WH		
4	Pestaña auxiliar de aire fresco	TBC-FF151US-E	MMU-UP0071 a 0561WH	Para entrada de aire fresco usando el agujero practicable de la unidad interior.	

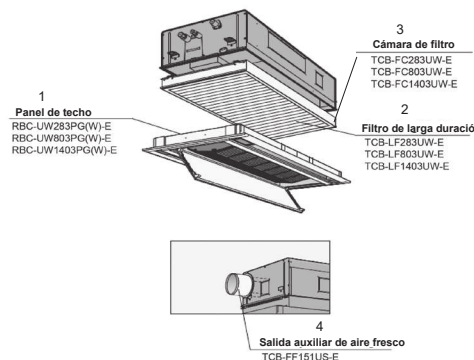

CONECTORES DEL CASSETTE DE 2 VÍAS

CN32	CN60	CN61	CN70	CN73	CN80
Control de ventilación adicional del control remoto	Salida de señal de estado de funcionamiento (refrigeración, calefacción, ventilador, desescarche, termostato on)	On/Off externo, salida de funcionamiento y salida de alarma	Símbolo de advertencia en el control remoto basado en la señal de entrada. Ninguna unidad interior con termostato desactivado.	Desconexión forzada del termostato de la unidad interior en función de la señal de entrada.	Desconexión forzada del termostato de la unidad interior y bloqueo de la unidad interior en función de la señal de entrada.